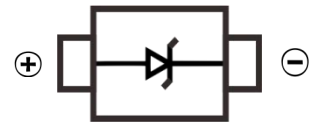

FEATURES

- Built-in strain relief
- Glass passivated junction
- Low inductance
- Excellent clamping capability
- Repetition Rate (duty cycle):0.01%
- Fast response time: typically less than 1.0ps
from 0 Volts to V(BR) for unidirectional types
- Typical IR less than 1mA above 10V
- High temperature soldering guaranteed: 260°C/10 seconds,
- Small Surface Mount device

SMA
MECHANICAL DATA

- Case: SMA(DO-214AC)
- Case Material: Molded Plastic. UL flammability
- Classification Rating: 94V-0
- Moisture Sensitivity: Level 1 per J-STD-020
- Weight: 0.065 grams (approximate)

MAXIMUM RATINGS AND CHARACTERISTICS(T_A = 25°C unless otherwise noted)

	Symbol	Value	Unit
Peak power dissipation with a 10/1000µs waveform (NOTE 1,2, FIG.1)	P _{PPM}	Minimum 400	W
Peak pulse current with a 10/1000µs waveform (NOTE 1)	I _{PPM}	See next table	A
Typical thermal resistance, junction to ambient (NOTE 3)	R _{θJA}	120.0	°C/W
Peak Forward Surge Current, 8.3ms Single Half Sine-Wave uni-directional only (NOTE 2)	I _{FSM}	40	A
Typical thermal resistance, junction to ambient (NOTE 3)	R _{θJL}	30	°C/W
Operating junction and storage temperature range	T _J , T _{STG}	-55 ~+150	°C

NOTES:

- (1) Non-repetitive current pulses, per Fig. 3 and derated above TA=25 per Fig. 2. Rating is 300W above 78V.
- (2) Mounted on 0.2 x 0.2" (5.0 x 5.0mm) copper pads to each terminal.
- (3) Mounted on minimum recommended pad layout.

ELECTRICAL CHARACTERISTICS

Ratings at 25 ambient temperature unless otherwise specified. VF=3.5V at IF=25A (uni-directional only)

Device type	HKT Type	Device marking code		Breakdown voltage V (BR) at $I_T^{(1)}$		Test current I_T (mA)	Stand-off voltage V_{WM} (V)	Maximum reverse leakage at V_{WM} I_B (μ A)(3)	Maximum peak pulse surge current I_{PPM} (A)(2)	Maximum clamping voltage at I_{PPM} V_C (V)
		UNI	BI	MIN	MAX					
SMAJ5.0	HDT5.0MA	AD	WD	6.4	7.8	10	5.0	800	41.7	9.6
SMAJ5.0A	HDT5.0AMA	AE	WE	6.4	7.1	10	5.0	800	43.5	9.2
SMAJ6.0	HDT6.0MA	AF	WF	6.7	8.2	10	6.0	800	35.1	11.4
SMAJ6.0A	HDT6.0AMA	AG	WG	6.7	7.4	10	6.0	800	38.8	10.3
SMAJ6.5	HDT6.5MA	AH	WH	7.2	8.8	10	6.5	500	32.5	12.3
SMAJ6.5A	HDT6.5AMA	AK	WK	7.2	8.0	10	6.5	500	35.7	11.2
SMAJ7.0	HDT7.0MA	AL	WL	7.8	9.5	10	7.0	200	30.1	13.3
SMAJ7.0A	HDT7.0AMA	AM	WM	7.8	8.6	10	7.0	200	33.3	12.0
SMAJ7.5	HDT7.5MA	AN	WN	8.3	10.2	1	7.5	100	28.0	14.3
SMAJ7.5A	HDT7.5AMA	AP	WP	8.3	9.2	1	7.5	100	31.0	12.9
SMAJ8.0	HDT8.0MA	AQ	WQ	8.9	10.9	1	8.0	50	26.7	15.0
SMAJ8.0A	HDT8.0AMA	AR	WR	8.9	9.8	1	8.0	50	29.4	13.6
SMAJ8.5	HDT8.5MA	AS	WS	9.4	11.5	1	8.5	10	25.2	15.9
SMAJ8.5A	HDT8.5AMA	AT	WT	9.4	10.4	1	8.5	10	27.8	14.4
SMAJ9.0	HDT9.0MA	AU	WU	10.0	12.2	1	9.0	5.0	23.7	16.9
SMAJ9.0A	HDT9.0AMA	AV	WV	10.0	11.1	1	9.0	5.0	26.0	15.4
SMAJ10	HDT10MA	AW	WW	11.1	12.3	1	10	5.0	21.3	18.8
SMAJ10A	HDT10AMA	AX	WX	11.1	14.9	1	10	5.0	23.5	17.0
SMAJ11	HDT11MA	AY	WY	12.2	13.5	1	11	5.0	19.9	20.1
SMAJ11A	HDT11AMA	AZ	WZ	12.2	16.3	1	11	5.0	22.0	18.2
SMAJ12	HDT12MA	BD	XD	13.3	14.7	1	12	5.0	18.2	22.0
SMAJ12A	HDT12AMA	BE	XE	13.3	17.6	1	12	5.0	20.1	19.9
SMAJ13	HDT13MA	BF	XF	14.4	15.9	1	13	5.0	16.8	23.8
SMAJ13A	HDT13AMA	BG	XG	14.4	19.1	1	13	5.0	18.6	21.5
SMAJ14	HDT14MA	BH	XH	15.6	17.2	1	14	5.0	15.5	25.8
SMAJ14A	HDT14AMA	BK	XK	15.6	20.4	1	14	5.0	17.2	23.2
SMAJ15	HDT15MA	BL	XL	16.7	18.5	1	15	5.0	14.9	26.9
SMAJ15A	HDT15AMA	BM	XM	16.7	21.8	1	15	5.0	16.4	24.4
SMAJ16	HDT16MA	BN	XN	17.8	19.7	1	16	5.0	13.9	28.8
SMAJ16A	HDT16AMA	BP	XP	17.8	23.1	1	16	5.0	15.4	26.0
SMAJ17	HDT17MA	BQ	XQ	18.9	20.9	1	17	5.0	13.1	30.5

Device type	HKT Type	Device marking code		Breakdown voltage V (BR) at $I_T^{(1)}$		Test current I_T (mA)	Stand-off voltage V_{WM} (V)	Maximum reverse leakage at V_{WM} I_D (uA)(3)	Maximum peak pulse surge current I_{PPM} (A)(2)	Maximum clamping voltage at I_{PPM} V_C (V)
		UNI	BI	MIN	MAX					
SMAJ17A	HDT17AMA	BR	XR	18.9	20.9	1	17.0	5.0	14.5	27.6
SMAJ18	HDT18MA	BS	XS	20.0	24.4	1	18.0	5.0	12.4	32.2
SMAJ18A	HDT18AMA	BT	XT	20.0	22.1	1	18.0	5.0	13.7	29.2
SMAJ20	HDT20MA	BU	XU	22.2	27.1	1	20.0	5.0	11.2	35.8
SMAJ20A	HDT20AMA	BV	XV	22.2	24.5	1	20.0	5.0	12.3	32.4
SMAJ22	HDT22MA	BW	XW	24.4	29.8	1	22.0	5.0	10.2	39.4
SMAJ22A	HDT22AMA	BX	XX	24.4	26.9	1	22.0	5.0	11.3	35.5
SMAJ24	HDT24MA	BY	XY	26.7	32.6	1	24.0	5.0	9.3	43.0
SMAJ24A	HDT24AMA	BZ	XZ	26.7	29.5	1	24	5.0	10.3	38.9
SMAJ26	HDT26MA	CD	YD	28.9	35.3	1	26.0	5.0	8.6	46.6
SMAJ26A	HDT26AMA	CE	YE	28.9	31.9	1	26.0	5.0	9.5	42.1
SMAJ28	HDT28MA	CF	YF	31.1	38.0	1	28	5.0	8.0	50.0
SMAJ28A	HDT28AMA	CG	YG	31.1	34.4	1	28	5.0	8.8	45.4
SMAJ30	HDT30MA	CH	YH	33.3	40.7	1	30	5.0	7.5	53.5
SMAJ30A	HDT30AMA	CK	YK	33.3	36.8	1	30	5.0	8.3	48.4
SMAJ33	HDT33MA	CL	YL	36.7	44.9	1	33	5.0	6.8	59.0
SMAJ33A	HDT33AMA	CM	YM	36.7	40.6	1	33	5.0	7.5	53.3
SMAJ36	HDT36MA	CN	YN	40.0	48.9	1	36	5.0	6.2	64.3
SMAJ36A	HDT36AMA	CP	YP	40.0	44.2	1	36	5.0	6.9	58.1
SMAJ40	HDT40MA	CQ	YQ	44.4	54.3	1	40	5.0	5.6	71.4
SMAJ40A	HDT40AMA	CR	YR	44.4	49.1	1	40	5.0	4.7	64.5
SMAJ43	HDT43MA	CS	YS	47.8	58.4	1	43	5.0	3.9	76.7
SMAJ43A	HDT43AMA	CT	YT	47.8	52.8	1	43	5.0	4.3	69.4
SMAJ45	HDT45MA	CU	YU	50.0	61.1	1	45	5.0	3.7	80.3
SMAJ45A	HDT45AMA	CV	YV	50.0	55.3	1	45	5.0	4.1	72.7
SMAJ48	HDT48MA	CW	YW	53.3	65.1	1	48	5.0	3.5	85.5
SMAJ48A	HDT48AMA	CX	YX	53.3	58.9	1	48	5.0	3.9	77.4
SMAJ51	HDT51MA	CY	YY	56.7	69.3	1	51	5.0	3.3	91.1
SMAJ51A	HDT51AMA	CZ	YZ	56.7	62.7	1	51	5.0	3.6	82.4
SMAJ54	HDT54MA	RD	ZD	60.0	73.3	1	54	5.0	3.1	96.3
SMAJ54A	HDT54AMA	RE	ZE	60.0	66.3	1	54	5.0	3.4	87.1
SMAJ58	HDT58MA	RF	ZF	64.4	78.7	1	58	5.0	2.9	103
SMAJ58A	HDT58AMA	RG	ZG	64.4	71.2	1	58	5.0	3.2	93.6

Device type	HKT Type	Device marking code		Breakdown voltage V (BR) at $I_T^{(1)}$		Test current I_T (mA)	Stand-off voltage V_{WM} (V)	Maximum reverse leakage at V_{WM} I_D (μ A)(3)	Maximum peak pulse surge current I_{PPM} (A)(2)	Maximum clamping voltage at I_{PPM} V_C (V)
		UNI	BI	MIN	MAX					
SMAJ60	HDT60MA	RH	ZH	66.7	81.5	1	60	5.0	2.8	107
SMAJ60A	HDT60AMA	RK	ZK	66.7	73.7	1	60	5.0	3.1	96.8
SMAJ64	HDT64MA	RL	ZL	77.1	86.9	1	64	5.0	2.6	114
SMAJ64A	HDT64AMA	RM	ZM	77.1	78.6	1	64	5.0	2.9	103
SMAJ70	HDT70MA	RN	ZN	77.8	95.1	1	70	5.0	2.4	125
SMAJ70A	HDT70AMA	RP	ZP	77.8	86.0	1	70	5.0	2.7	113
SMAJ75	HDT75MA	RQ	ZQ	83.3	102	1	75	5.0	2.2	134
SMAJ75A	HDT75AMA	RR	ZR	83.3	92.1	1	75	5.0	2.5	121
SMAJ78	HDT78MA	RS	ZS	86.7	106	1	78	5.0	2.2	139
SMAJ78A	HDT78AMA	RT	ZT	86.7	95.8	1	78	5.0	2.4	126
SMAJ85	HDT85MA	RU	ZU	94.4	115	1	85	5.0	2.0	151
SMAJ85A	HDT85AMA	RV	ZV	94.4	104	1	85	5.0	2.2	137
SMAJ90	HDT90MA	RW	ZW	100	122	1	90	5.0	1.9	160
SMAJ90A	HDT90AMA	RX	ZX	100	111	1	90	5.0	2.1	146
SMAJ100	HDT100MA	RY	ZY	111	136	1	100	5.0	1.7	179
SMAJ100A	HDT100AMA	RZ	ZZ	111	123	1	100	5.0	1.9	162
SMAJ110	HDT110MA	SD	VD	122	149	1	110	5.0	1.5	196
SMAJ110A	HDT110AMA	SE	VE	122	135	1	110	5.0	1.7	177
SMAJ120	HDT120MA	SF	VF	133	163	1	120	5.0	1.4	214
SMAJ120A	HDT120AMA	SG	VG	133	147	1	120	5.0	1.6	193
SMAJ130	HDT130MA	SH	VH	144	176	1	130	5.0	1.3	231
SMAJ130A	HDT130AMA	SK	VK	144	159	1	130	5.0	1.4	209
SMAJ150	HDT150MA	SL	VL	167	204	1	150	5.0	1.1	268
SMAJ150A	HDT150AMA	SM	VM	167	185	1	150	5.0	1.2	243
SMAJ160	HDT160MA	SN	VN	178	218	1	160	5.0	1.0	287
SMAJ160A	HDT160AMA	SP	VP	178	197	1	160	5.0	1.2	259
SMAJ170	HDT170MA	SQ	VQ	189	231	1	170	5.0	0.99	304
SMAJ170A	HDT170AMA	SR	VR	189	209	1	170	5.0	1.09	275
SMAJ188	HDT188MA	ST	VT	209	255	1	188	5.0	0.9	344
SMAJ188A	HDT188AMA	SS	VS	209	231	1	188	5.0	0.91	328

Notes: (1) Pulse test : T_P 50ms

(2) Surge current waveform per Fig.3 and derate per Fig.2

(3) For bi-directional types having V_{WM} of 10 Volts and less, the I_D Limit is doubled

(4) All terms and symbols are consistent with A NSI/IEEE C62.35

(5) For the bidirectional SMAJ5.0CA, the maximum $V(BR)$ is 7.25V

Typical Characteristics

FIG.1 – PEAK PULSE POWER RATING CURVE

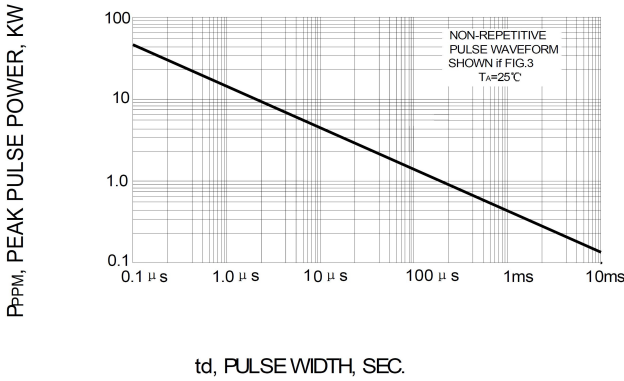

FIG.2 – PULSE DERATING CURVE

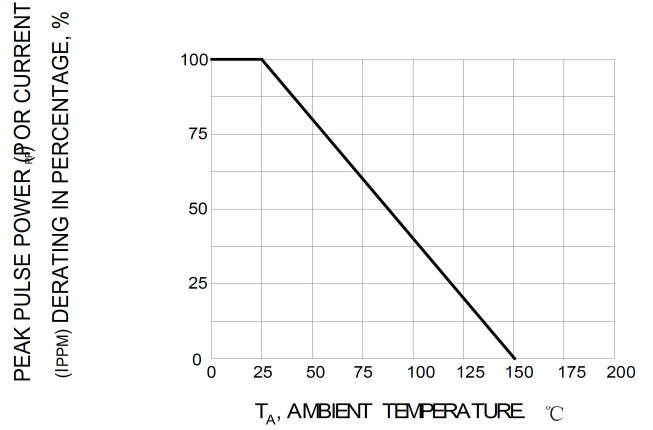

FIG.3 – PULSE WAVEFORM

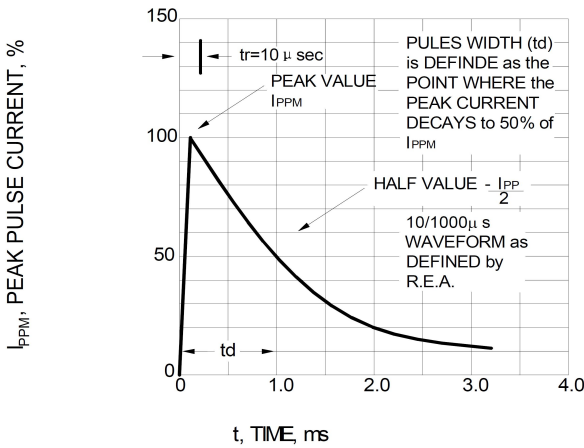

FIG.4 – TYPICAL JUNCTION CAPACITANCE UNIDIRECTIONAL

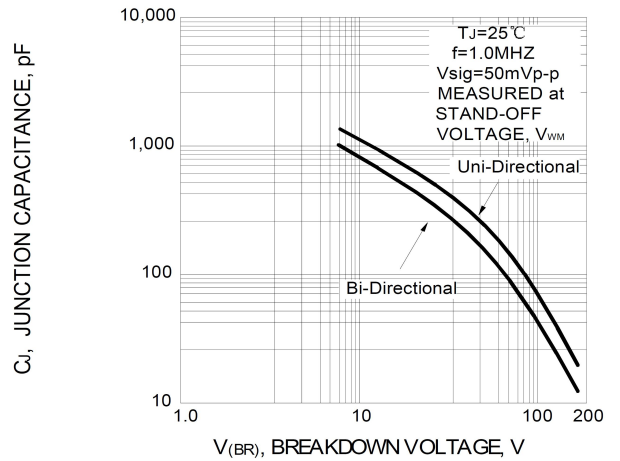

FIG.5 – TYPICAL TRANSIENT THERMAL IMPEDANCE

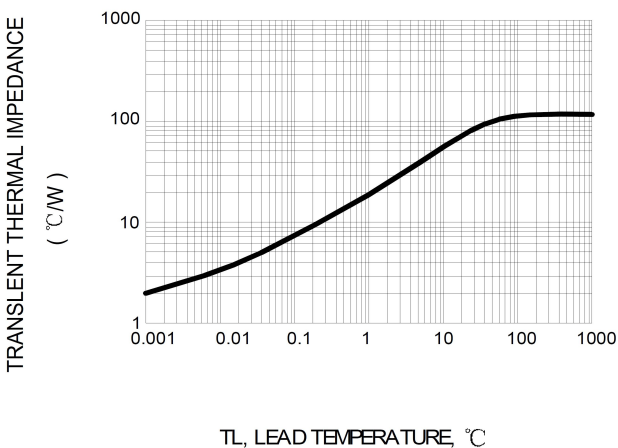
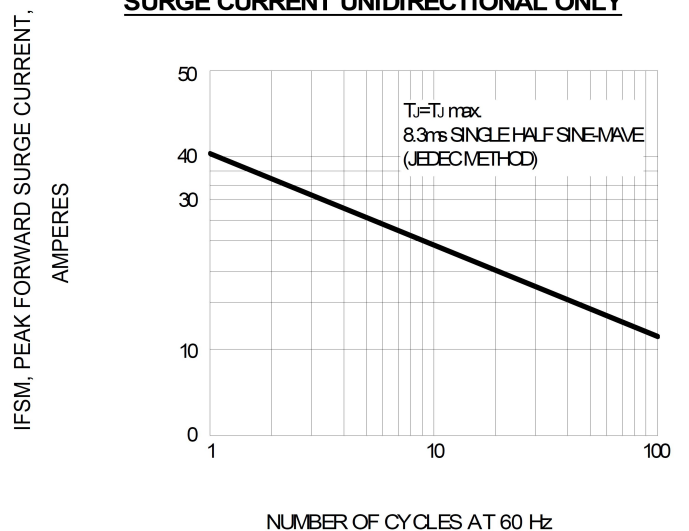
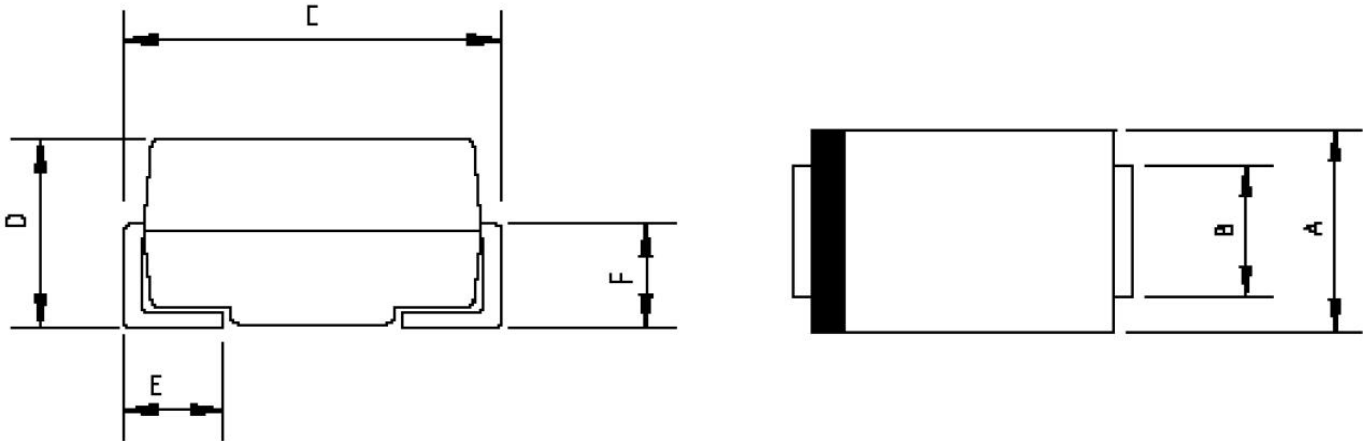

FIG.6 – MAXIMUM NON-REPETITIVE FORWARD SURGE CURRENT UNIDIRECTIONAL ONLY



SMA Package Outline Dimensions



Symbol	Dimensions In Millimeters		Dimensions In Inches	
	Min.	Max.	Min.	Max.
A	2.20	2.80	0.086	0.110
B	1.30	1.70	0.051	0.067
C	4.70	5.30	0.185	0.209
D	1.70	2.55	0.067	0.100
E	0.90	1.50	0.035	0.059
F	0.90	1.50	0.035	0.059

SMA Suggested Pad Layout

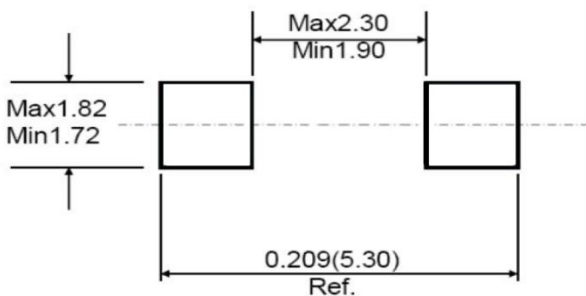

Note:

1. Controlling dimension: in millimeters
2. General tolerance: ± 0.05 mm
3. The pad layout is for reference purposes only

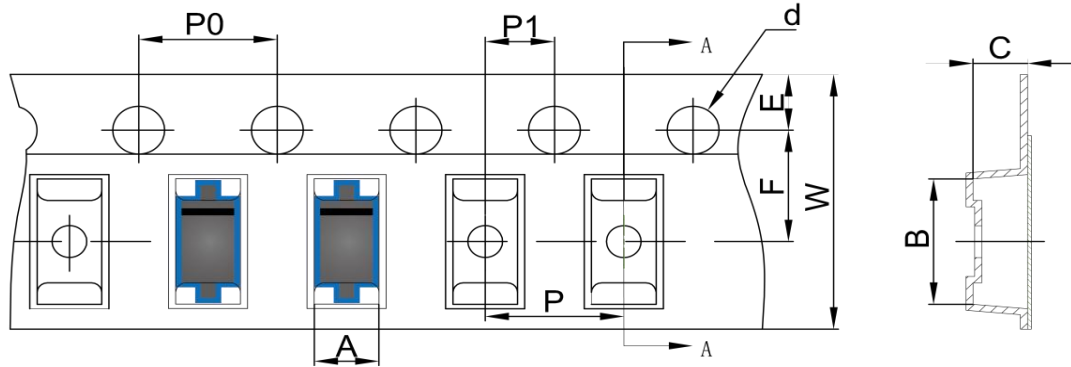
SMA Tape and Reel
SMA Embossed Carrier Tape

DIMENSIONS ARE IN MILLIMETER										
TYPE	A	B	C	d	E	F	P0	P	P1	W
SMA	2.89	5.35	2.68	Ø1.50	1.75	5.50	4.00	4.00	2.00	12.00
TOLERANCE	±0.1	±0.1	±0.1	±0.1	±0.1	±0.1	±0.1	±0.1	±0.1	±0.1

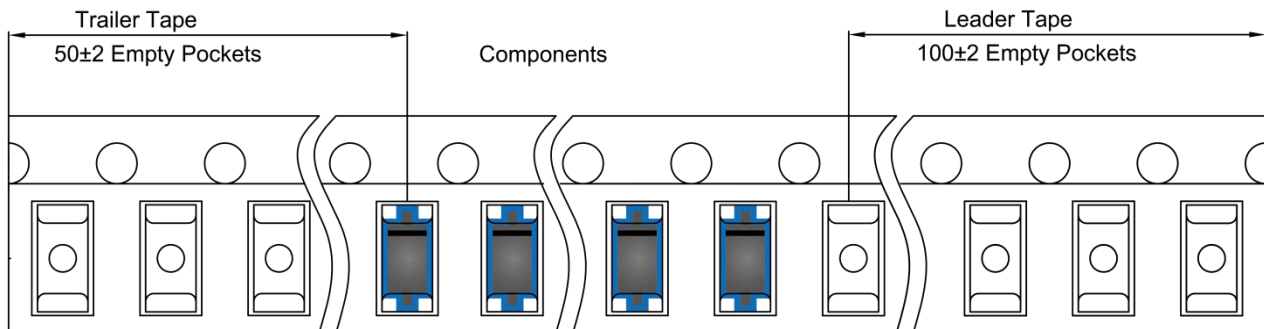
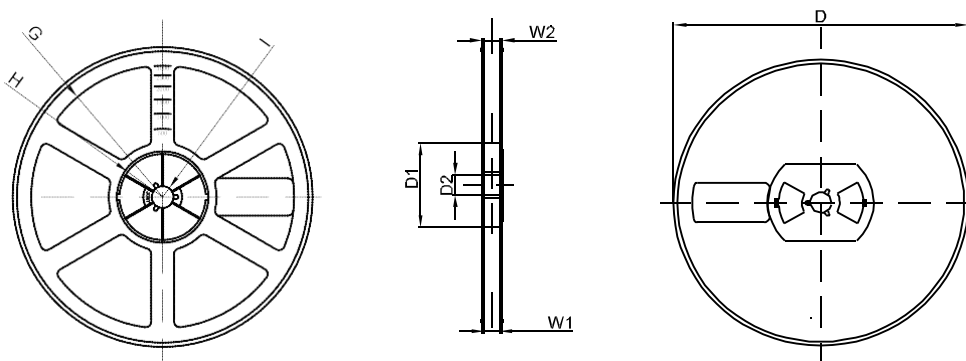
SMA Tape Leader and Trailer

SMA Reel

DIMENSIONS ARE IN MILLIMETER								
REEL OPTION	D	D1	D2	G	H	I	W1	W2
7" DIA	Ø178	54.40	13.00	R78	R25.60	R6.50	12.40	17.60
TOLERANCE	±2	±1	±1	±1	±1	±1	±1	±1