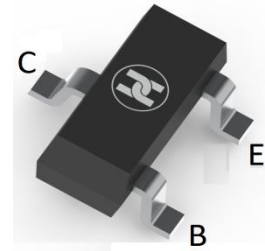
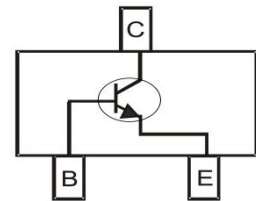

**BIPOLAR TRANSISTOR (NPN)**
**FEATURES**

- High DC current gain : $h_{FE}=200(\text{Typ})$   $V_{CE}=6V, I_C=1\text{mA}$
- High voltage: $V_{CEO}=50V$
- Surface Mount device
- Complementary to 2SA812

**SOT-23**

**MECHANICAL DATA**

- Case: SOT-23
- Case Material: Molded Plastic. UL flammability
- Classification Rating: 94V-0
- Weight: 0.008 grams (approximate)

**MAXIMUM RATINGS ( $T_A = 25^\circ\text{C}$  unless otherwise noted)**

Parameter	Symbol	Value	Unit
Collector-Base Voltage	$V_{CBO}$	60	V
Collector-Emitter Voltage	$V_{CEO}$	50	V
Emitter-Base Voltage	$V_{EBO}$	5	V
Collector Current	$I_C$	100	mA
Collector Power Dissipation	$P_C$	200	mW
Thermal Resistance From Junction To Ambient	$R_{\theta JA}$	625	$^\circ\text{C}/\text{W}$
Junction Temperature	$T_J$	150	$^\circ\text{C}$
Storage Temperature	$T_{STG}$	-55 ~ +150	$^\circ\text{C}$

**ELECTRICAL CHARACTERISTICS ( $T_A = 25^\circ\text{C}$  unless otherwise specified)**

Parameter	Symbol	Min	Typ	Max	Unit	Conditions
Collector-base breakdown voltage	$V_{(BR)CBO}$	60			V	$I_C=100\mu\text{A}, I_E=0$
Collector-emitter breakdown voltage	$V_{(BR)CEO}$	50			V	$I_C=1\text{mA}, I_B=0$
Emitter-base breakdown voltage	$V_{(BR)EBO}$	5			V	$I_E=100\mu\text{A}, I_C=0$
Collector cut-off current	$I_{CBO}$			0.1	$\mu\text{A}$	$V_{CB}=60V, I_E=0$
Emitter cut-off current	$I_{EBO}$			0.1	$\mu\text{A}$	$V_{EB}=5V, I_C=0$
DC current gain	$h_{FE}$	90	200	600		$V_{CE}=6V, I_C=1\text{mA}$
Collector-emitter saturation voltage	$V_{CE(sat)}$			0.3	V	$I_C=100\text{mA}, I_B=10\text{mA}$
Base-emitter saturation voltage	$V_{BE(sat)}$			1	V	$I_C=100\text{mA}, I_B=10\text{mA}$
Transition frequency	$f_T$		250		MHz	$V_{CE}=6V, I_C=10\text{mA}$

**CLASSIFICATION OF  $h_{FE}$** 

Rank	L4	L5	L6	L7
Range	90-180	135-270	200-400	300-600
Marking	L4	L5	L6	L7

**BIPOLAR TRANSISTOR (NPN)**

**Typical Characteristics**

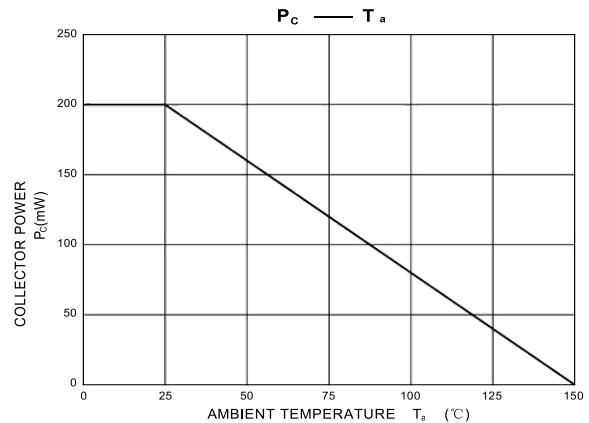
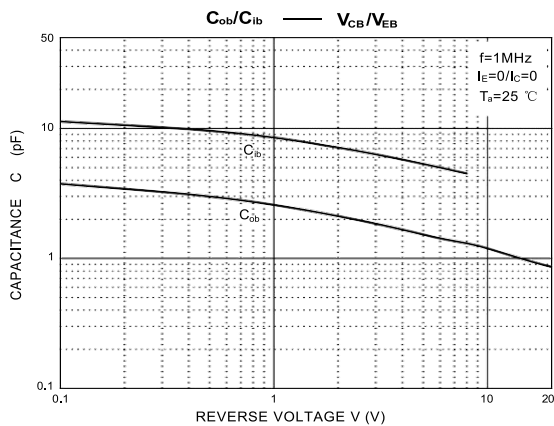
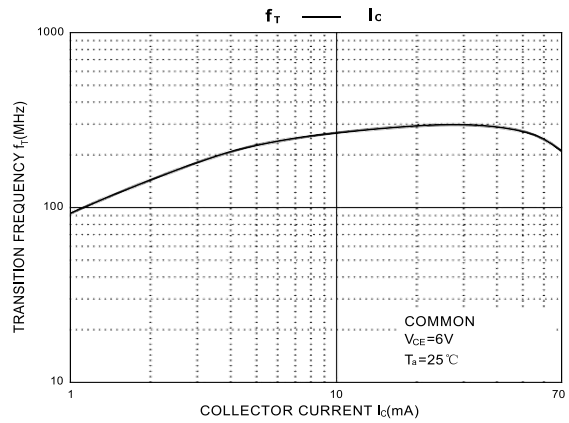
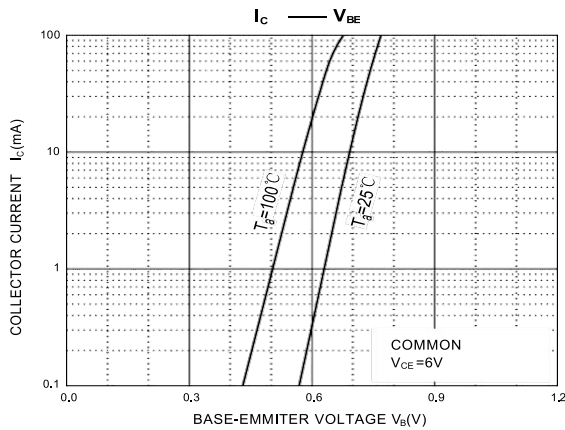
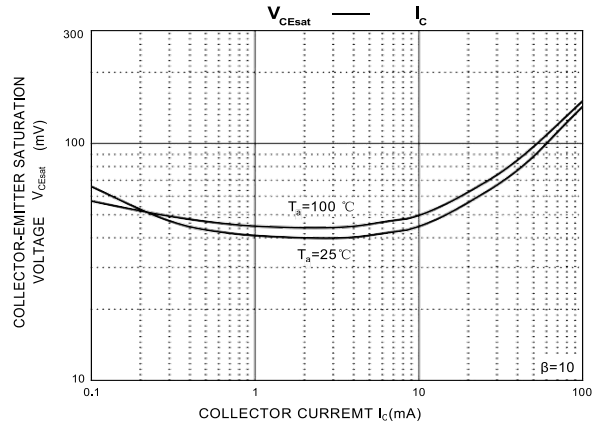
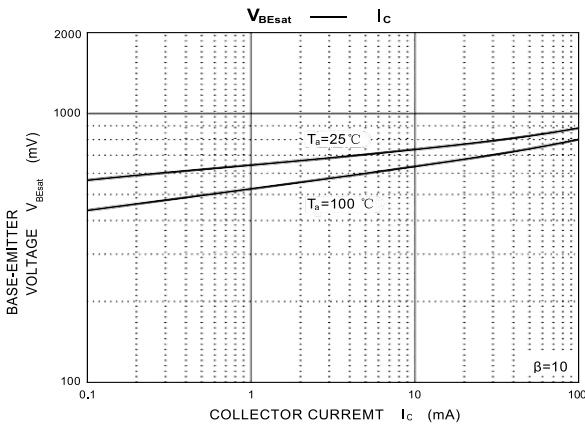
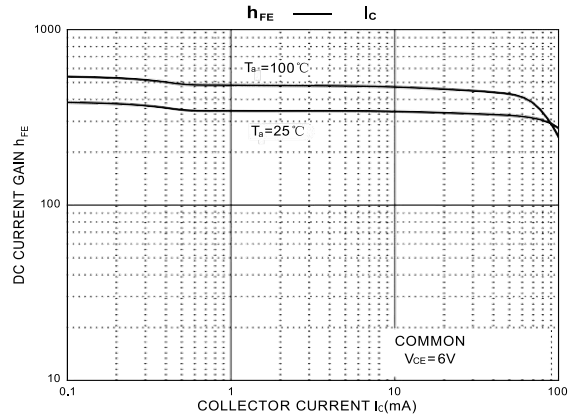
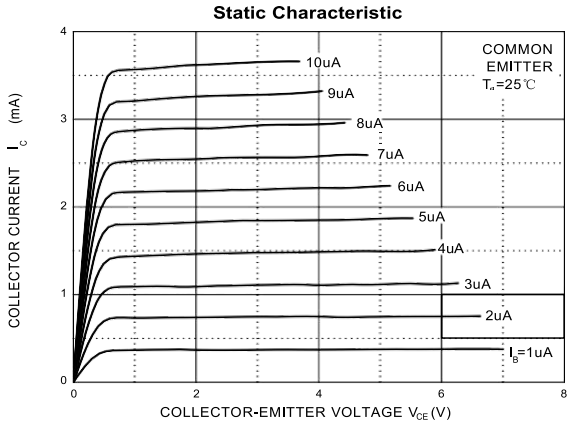

**BIPOLAR TRANSISTOR (NPN)**

**SOT-23 Package Outline Dimensions**

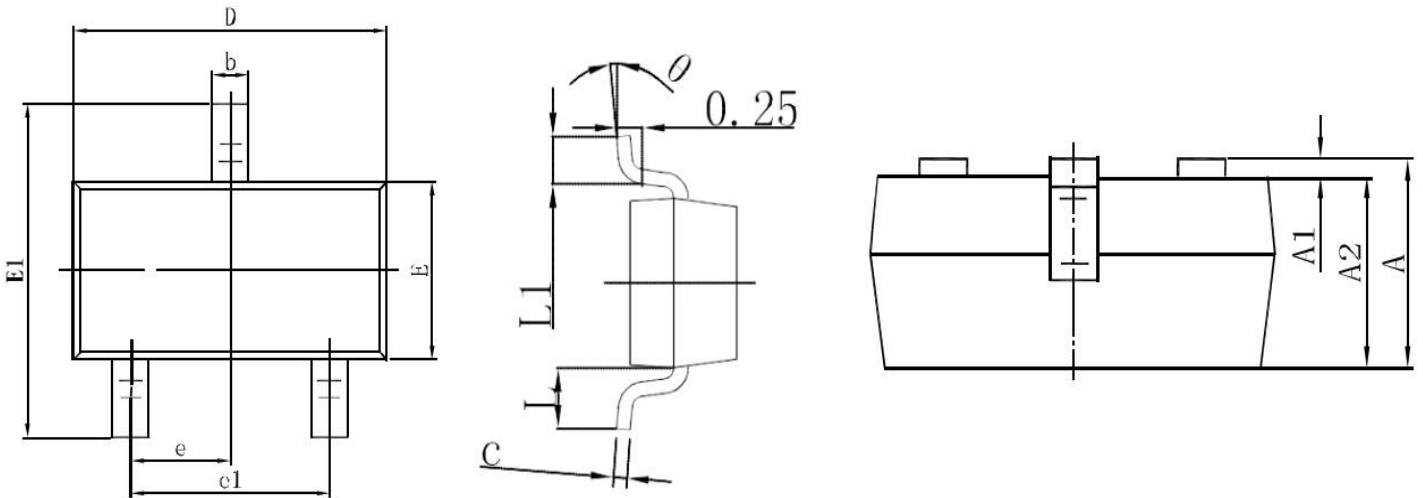

Symbol	Dimensions In Millimeters		Dimensions In Inches	
	Min	Max	Min	Max
A	0.900	1.150	0.354	0.453
A1	0.000	0.100	0.000	0.039
A2	0.900	1.050	0.354	0.413
b	0.300	0.500	0.118	0.197
c	0.080	1.150	0.031	0.453
D	2.900	3.100	1.142	1.220
E	1.200	1.400	0.472	0.551
E1	2.250	2.550	0.886	1.004
e	0.95REF		0.374REF	
e1	1.800	2.000	0.709	0.787
L	0.55REF		0.215REF	
L1	0.300	0.500	0.118	0.197

**SOT-23 Suggested Pad Layout**

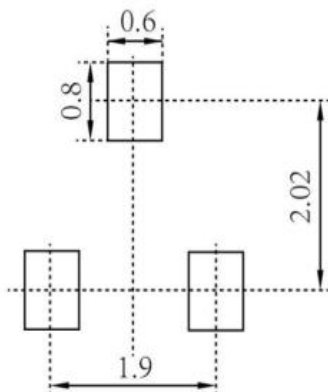

Note:

1. Controlling dimension: in millimeters
2. General tolerance:  $\pm 0.05\text{mm}$
3. The pad layout is for reference purposes only

**BIPOLAR TRANSISTOR (NPN)**

**SOT-23 Tape and Reel**

**SOT-23 Embossed Carrier Tape**

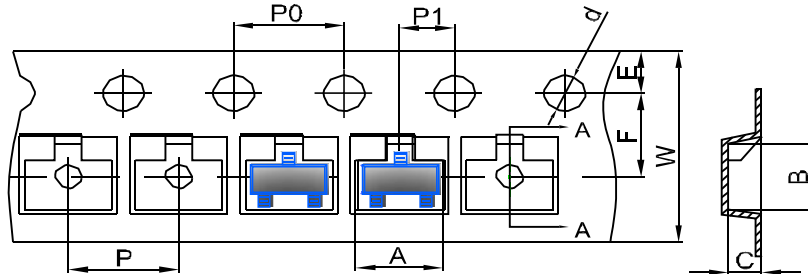

DIMENSIONS ARE IN MILLIMETER										
TYPE	A	B	C	d	E	F	P0	P	P1	W
SOT-23	3.15	2.77	1.22	Ø1.50	1.75	3.50	4.00	4.00	2.00	8.00
TOLERANCE	±0.1	±0.1	±0.1	±0.1	±0.1	±0.1	±0.1	±0.1	±0.1	±0.1

**SOT-23 Tape Leader and Trailer**

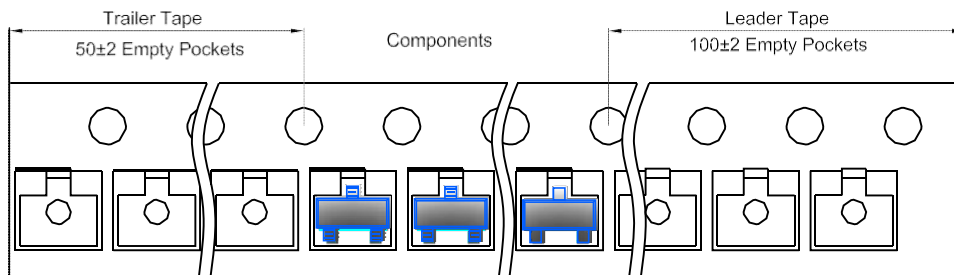

**SOT-23 Reel**

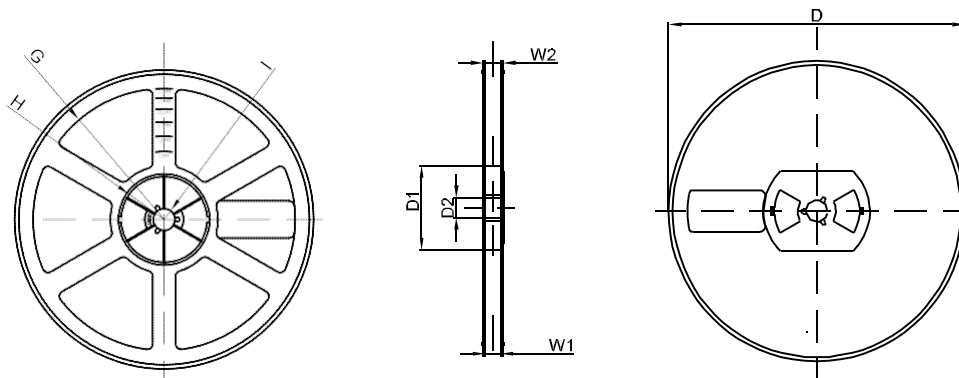

DIMENSIONS ARE IN MILLIMETER								
REEL OPTION	D	D1	D2	G	H	I	W1	W2
7" DIA	Ø178	54.40	13.00	R78	R25.60	R6.50	9.50	12.30
TOLERANCE	±2	±1	±1	±1	±1	±1	±1	±1