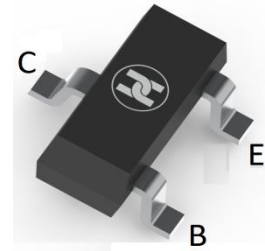
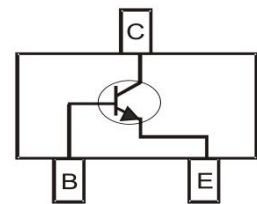

BIPOLAR TRANSISTOR (NPN)
FEATURES

- High current And High voltage
- Excellent h_{FE} Linearity
- Low Noise
- Surface Mount device
- Complementary to 2SA1015

SOT-23

MECHANICAL DATA

- Case: SOT-23
- Case Material: Molded Plastic. UL flammability
- Classification Rating: 94V-0
- Weight: 0.008 grams (approximate)

MAXIMUM RATINGS ($T_A = 25^\circ\text{C}$ unless otherwise noted)

Parameter	Symbol	Value	Unit
Collector-Base Voltage	V_{CBO}	60	V
Collector-Emitter Voltage	V_{CEO}	50	V
Emitter-Base Voltage	V_{EBO}	5	V
Collector Current	I_C	150	mA
Collector Power Dissipation	P_C	200	mW
Thermal Resistance From Junction To Ambient	$R_{\theta JA}$	625	$^\circ\text{C}/\text{W}$
Junction Temperature	T_J	150	$^\circ\text{C}$
Storage Temperature	T_{STG}	-55 ~ +150	$^\circ\text{C}$

ELECTRICAL CHARACTERISTICS ($T_A = 25^\circ\text{C}$ unless otherwise specified)

Parameter	Symbol	Min	Typ	Max	Unit	Conditions
Collector-base breakdown voltage	$V_{(BR)CBO}$	60			V	$I_C=100\mu\text{A}$, $I_E=0$
Collector-emitter breakdown voltage	$V_{(BR)CEO}$	50			V	$I_C=0.1\text{mA}$, $I_B=0$
Emitter-base breakdown voltage	$V_{(BR)EBO}$	5			V	$I_E=100\mu\text{A}$, $I_C=0$
Collector cut-off current	I_{CBO}			0.1	μA	$V_{CB}=60\text{V}$, $I_E=0$
Emitter cut-off current	I_{EBO}			0.1	μA	$V_{EB}=5\text{V}$, $I_C=0$
DC current gain	h_{FE}	130		400		$V_{CE}=6\text{V}$, $I_C=2\text{mA}$
Collector-emitter saturation voltage	$V_{CE(sat)}$			0.25	V	$I_C=100\text{mA}$, $I_B=10\text{mA}$
Base-emitter saturation voltage	$V_{BE(sat)}$			1	V	$I_C=100\text{mA}$, $I_B=10\text{mA}$
Transition frequency	f_T	80			MHz	$V_{CE}=10\text{V}$, $I_C=1\text{mA}$, $f=30\text{MHz}$

CLASSIFICATION OF h_{FE}

Rank	L	H
Range	130-200	200-400
Marking	HF	

BIPOLAR TRANSISTOR (NPN)

Typical Characteristics

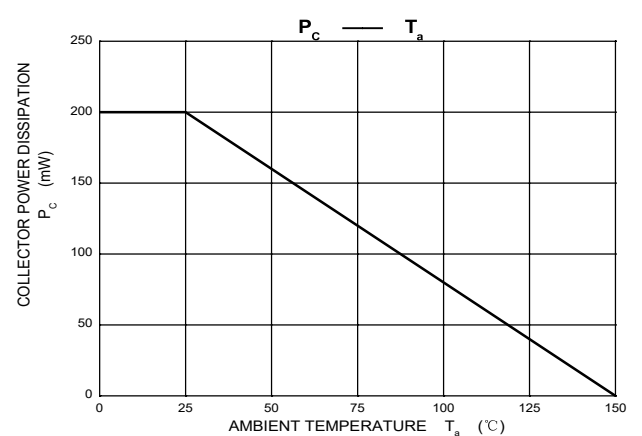
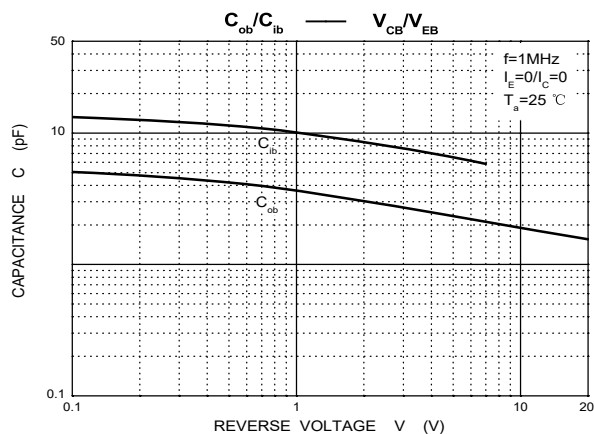
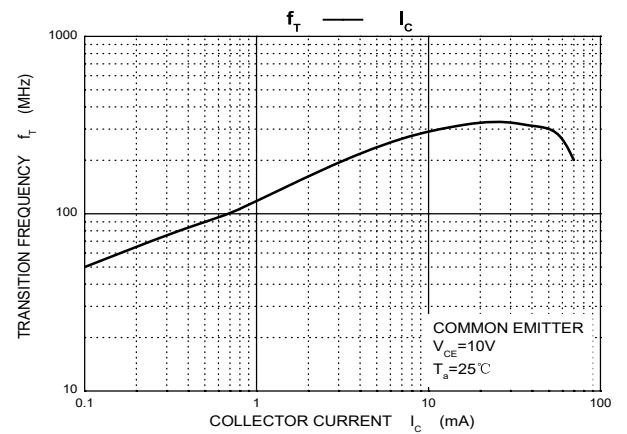
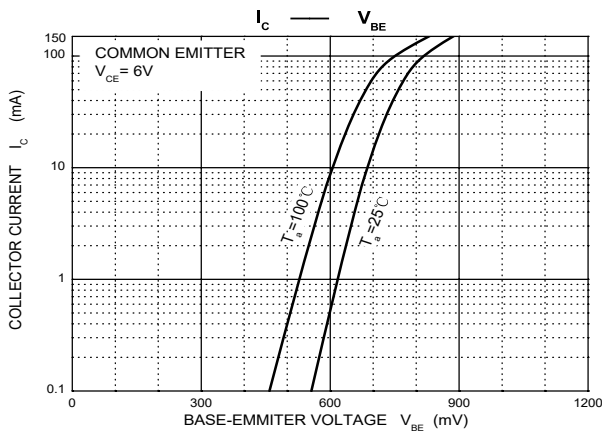
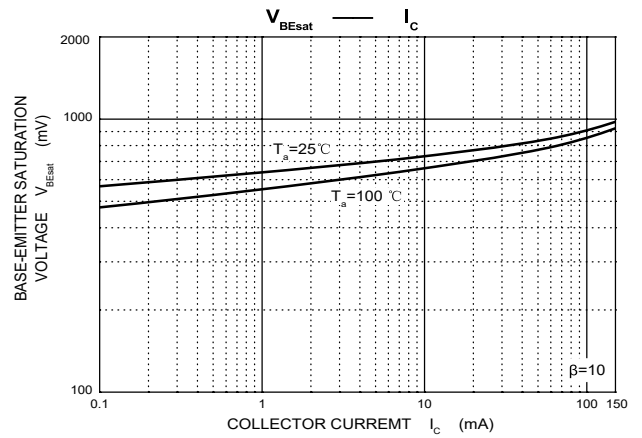
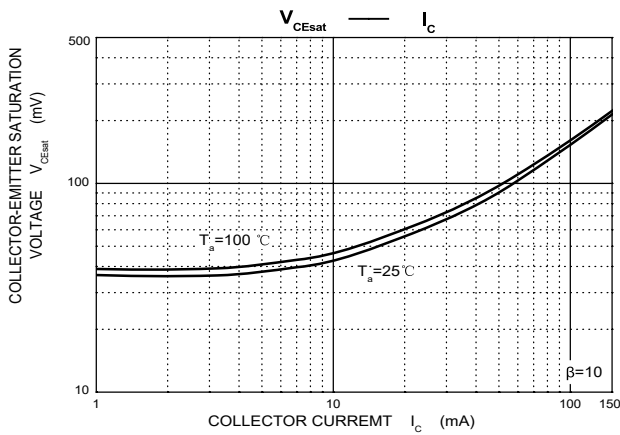
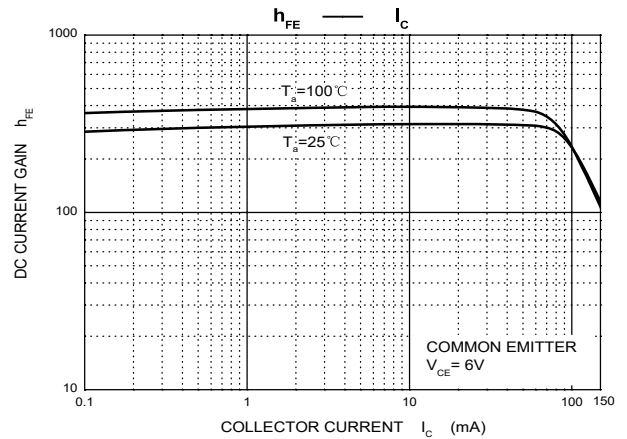
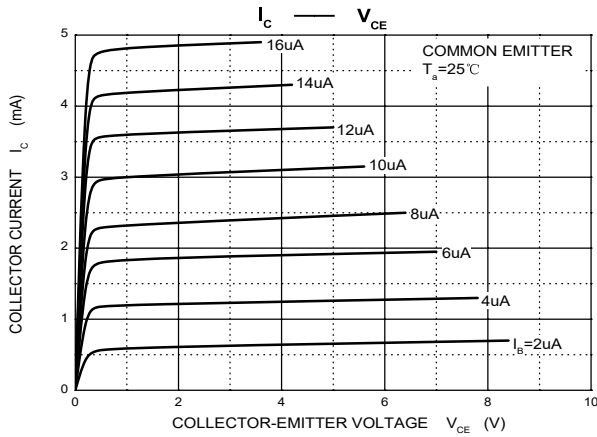

BIPOLAR TRANSISTOR (NPN)

SOT-23 Package Outline Dimensions

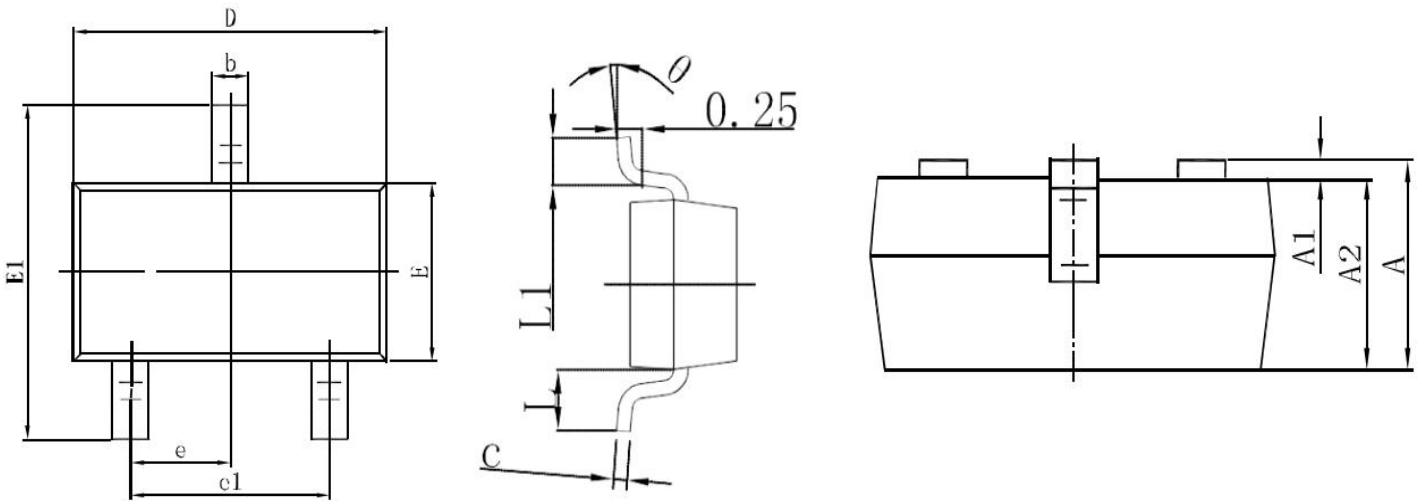

Symbol	Dimensions In Millimeters		Dimensions In Inches	
	Min	Max	Min	Max
A	0.900	1.150	0.354	0.453
A1	0.000	0.100	0.000	0.039
A2	0.900	1.050	0.354	0.413
b	0.300	0.500	0.118	0.197
c	0.080	1.150	0.031	0.453
D	2.900	3.100	1.142	1.220
E	1.200	1.400	0.472	0.551
E1	2.250	2.550	0.886	1.004
e	0.95REF		0.374REF	
e1	1.800	2.000	0.709	0.787
L	0.55REF		0.215REF	
L1	0.300	0.500	0.118	0.197

SOT-23 Suggested Pad Layout

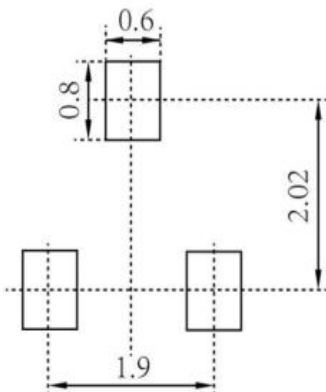

Note:

1. Controlling dimension: in millimeters
2. General tolerance: $\pm 0.05\text{mm}$
3. The pad layout is for reference purposes only

BIPOLAR TRANSISTOR (NPN)

SOT-23 Tape and Reel

SOT-23 Embossed Carrier Tape

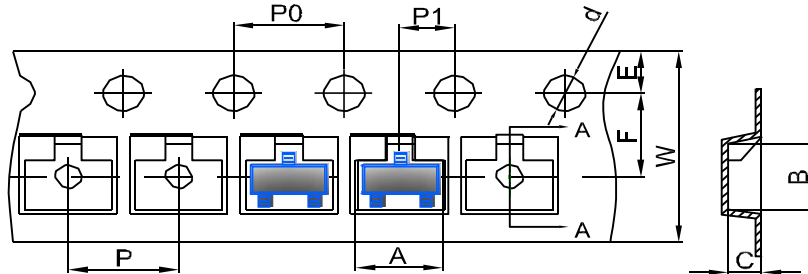

DIMENSIONS ARE IN MILLIMETER										
TYPE	A	B	C	d	E	F	P0	P	P1	W
SOT-23	3.15	2.77	1.22	Ø1.50	1.75	3.50	4.00	4.00	2.00	8.00
TOLERANCE	±0.1	±0.1	±0.1	±0.1	±0.1	±0.1	±0.1	±0.1	±0.1	±0.1

SOT-23 Tape Leader and Trailer

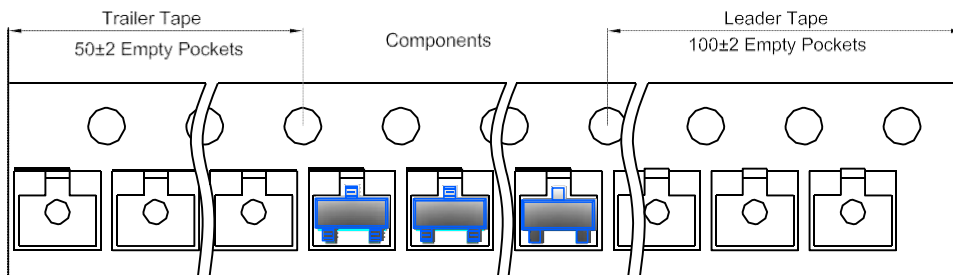

SOT-23 Reel

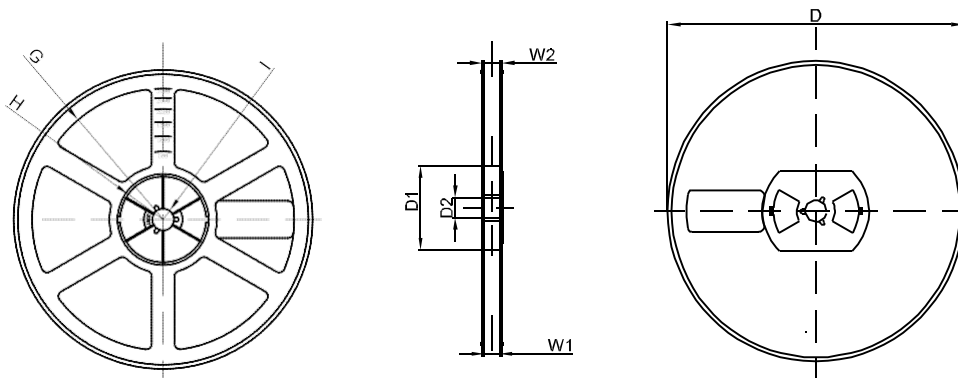

DIMENSIONS ARE IN MILLIMETER								
REEL OPTION	D	D1	D2	G	H	I	W1	W2
7" DIA	Ø178	54.40	13.00	R78	R25.60	R6.50	9.50	12.30
TOLERANCE	±2	±1	±1	±1	±1	±1	±1	±1