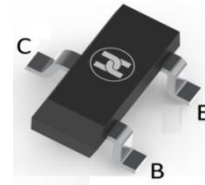
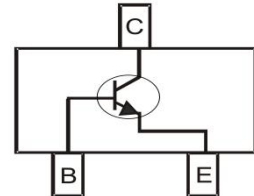

**BIPOLAR TRANSISTOR (NPN)**
**FEATURES**

- Small reverse transfer capacitance
- Low Noise
- Surface Mount device

**SOT-23**
**MECHANICAL DATA**

- Case: SOT-23
- Case Material: Molded Plastic. UL flammability
- Classification Rating: 94V-0
- Weight: 0.008 grams (approximate)

**MAXIMUM RATINGS (T<sub>A</sub> = 25°C unless otherwise noted)**

Parameter	Symbol	Value	Unit
Collector-Base Voltage	V <sub>CB0</sub>	40	V
Collector-Emitter Voltage	V <sub>CEO</sub>	30	V
Emitter-Base Voltage	V <sub>EBO</sub>	4	V
Collector Current	I <sub>C</sub>	20	mA
Collector Power Dissipation	P <sub>C</sub>	100	mW
Thermal Resistance From Junction To Ambient	R <sub>θJA</sub>	1000	°C/W
Junction Temperature	T <sub>J</sub>	125	°C
Storage Temperature	T <sub>STG</sub>	-55 ~+150	°C

**ELECTRICAL CHARACTERISTICS (T<sub>A</sub> = 25°C unless otherwise specified)**

Parameter	Symbol	Min	Typ	Max	Unit	Conditions
Collector-base breakdown voltage	V <sub>(BR)CBO</sub>	40			V	I <sub>C</sub> =10uA, I <sub>E</sub> =0
Collector-emitter breakdown voltage	V <sub>(BR)CEO</sub>	30			V	I <sub>C</sub> =1mA, I <sub>B</sub> =0
Emitter-base breakdown voltage	V <sub>(BR)EBO</sub>	4			V	I <sub>E</sub> =10uA, I <sub>C</sub> =0
Collector cut-off current	I <sub>CBO</sub>			0.5	uA	V <sub>CB</sub> =18V, I <sub>E</sub> =0
Emitter cut-off current	I <sub>EBO</sub>			0.5	uA	V <sub>EB</sub> =4V, I <sub>C</sub> =0
DC current gain	h <sub>FE</sub>	40		200		V <sub>CE</sub> =6V, I <sub>C</sub> =1mA
Transition frequency	f <sub>T</sub>		500		MHz	V <sub>CE</sub> =6V, I <sub>C</sub> =1mA
Reverse transfer capacitance	C <sub>RE</sub>		0.7		pF	V <sub>CE</sub> =6V, I <sub>E</sub> =0, f=1MHz
Noise figure	NF		2.5	5	dB	V <sub>CE</sub> =6V, I <sub>C</sub> =1mA, f=100MHz

**CLASSIFICATION OF h<sub>FE</sub>**

Rank	R	O	Y
Range	40-80	70-140	100-200
Marking	QR	QO	QY

**BIPOLAR TRANSISTOR (NPN)**

**Typical Characteristics**

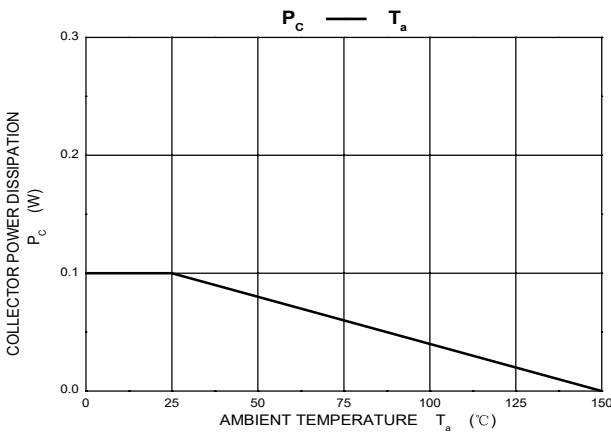
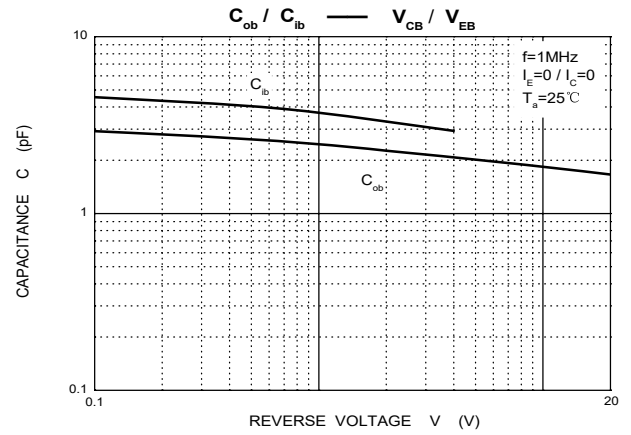
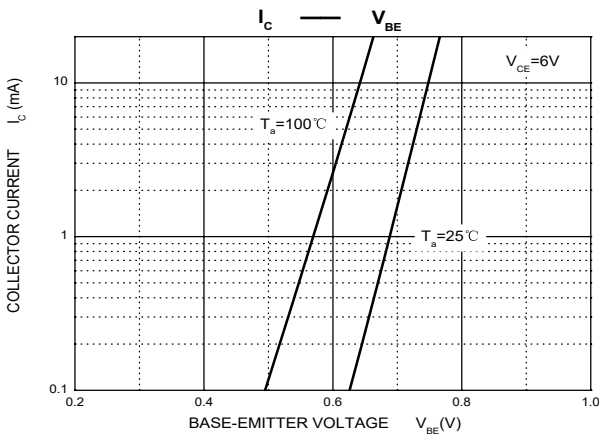
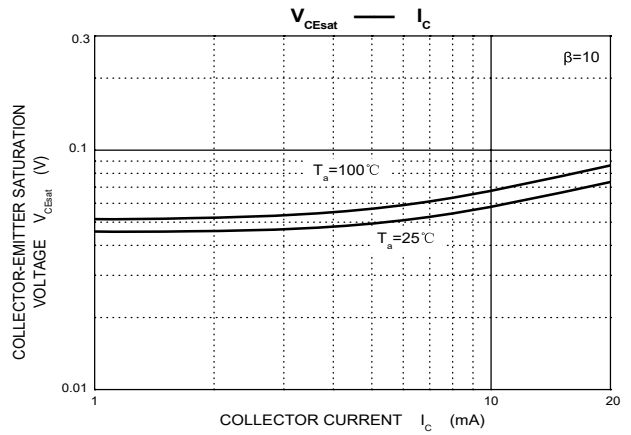
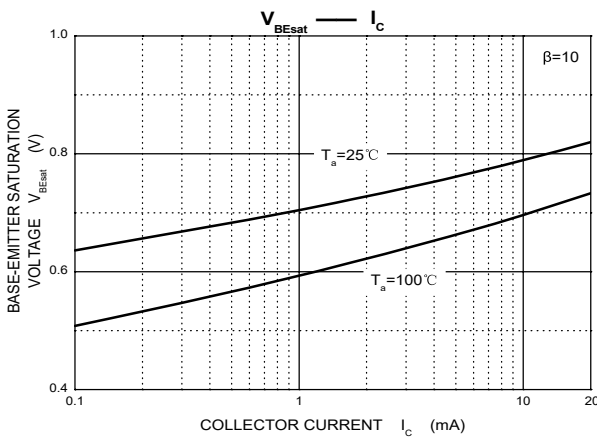
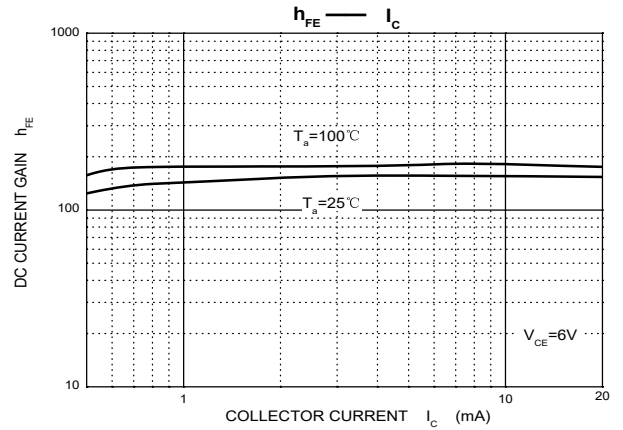
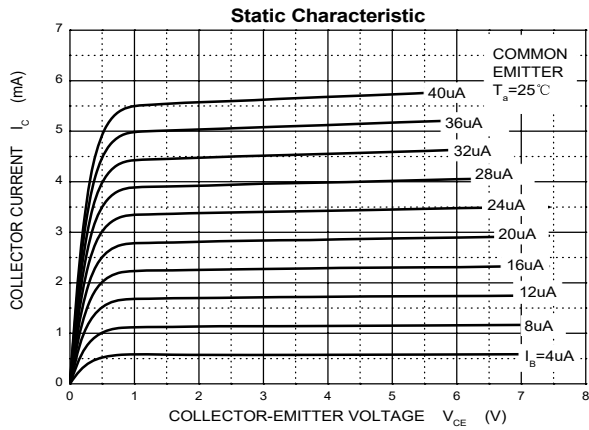

**BIPOLAR TRANSISTOR (NPN)**

**SOT-23 Package Outline Dimensions**

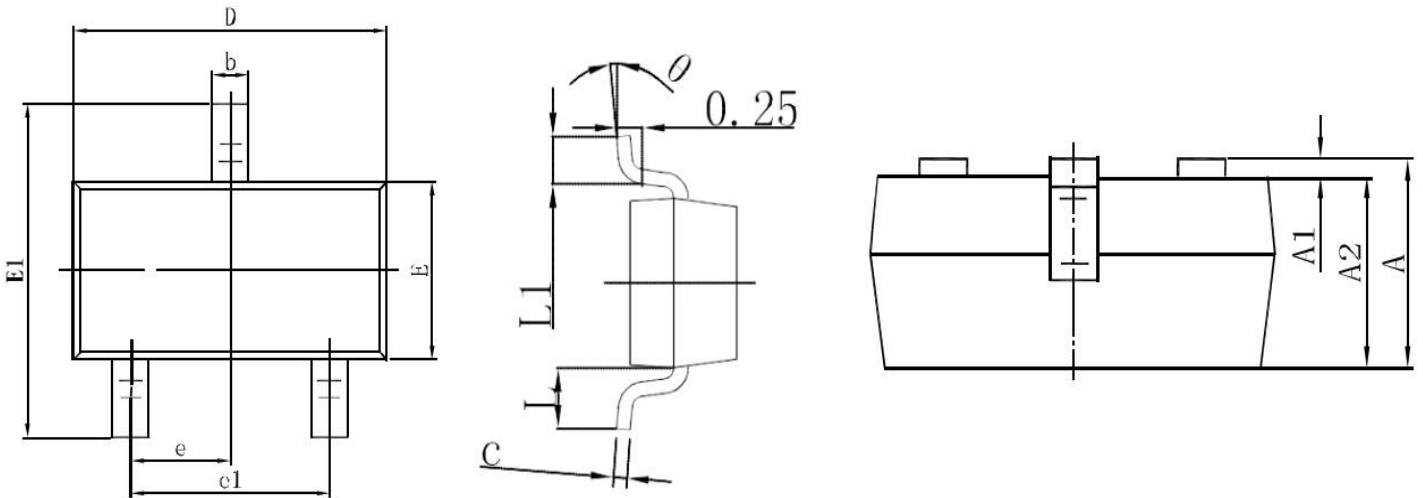

Symbol	Dimensions In Millimeters		Dimensions In Inches	
	Min	Max	Min	Max
A	0.900	1.150	0.354	0.453
A1	0.000	0.100	0.000	0.039
A2	0.900	1.050	0.354	0.413
b	0.300	0.500	0.118	0.197
c	0.080	1.150	0.031	0.453
D	2.900	3.100	1.142	1.220
E	1.200	1.400	0.472	0.551
E1	2.250	2.550	0.886	1.004
e	0.95REF		0.374REF	
e1	1.800	2.000	0.709	0.787
L	0.55REF		0.215REF	
L1	0.300	0.500	0.118	0.197

**SOT-23 Suggested Pad Layout**

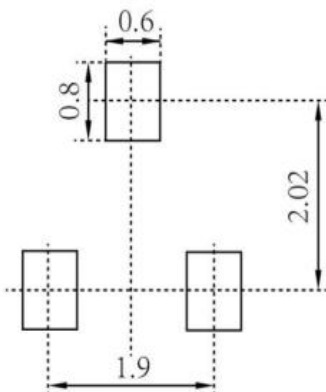

Note:

1. Controlling dimension: in millimeters
2. General tolerance:  $\pm 0.05\text{mm}$
3. The pad layout is for reference purposes only

**BIPOLAR TRANSISTOR (NPN)**

**SOT-23 Tape and Reel**

**SOT-23 Embossed Carrier Tape**

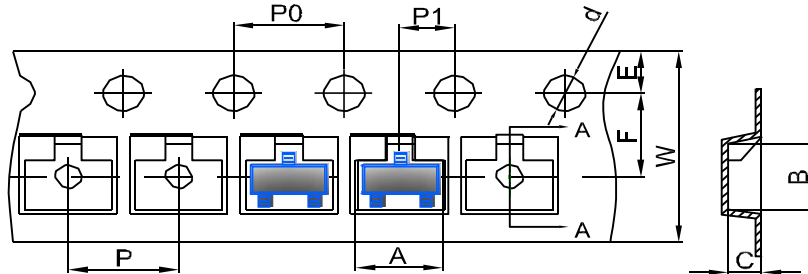

DIMENSIONS ARE IN MILLIMETER										
TYPE	A	B	C	d	E	F	P0	P	P1	W
SOT-23	3.15	2.77	1.22	Ø1.50	1.75	3.50	4.00	4.00	2.00	8.00
TOLERANCE	±0.1	±0.1	±0.1	±0.1	±0.1	±0.1	±0.1	±0.1	±0.1	±0.1

**SOT-23 Tape Leader and Trailer**

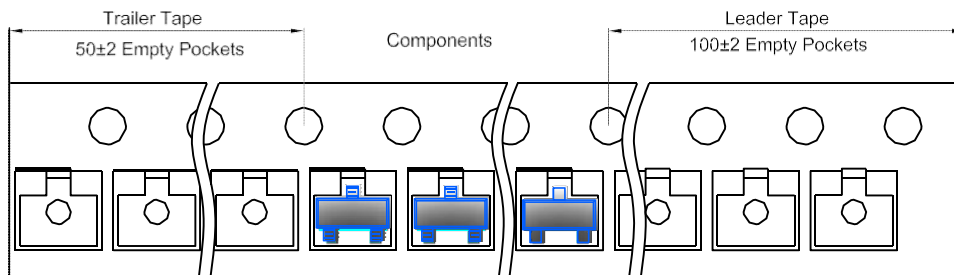

**SOT-23 Reel**

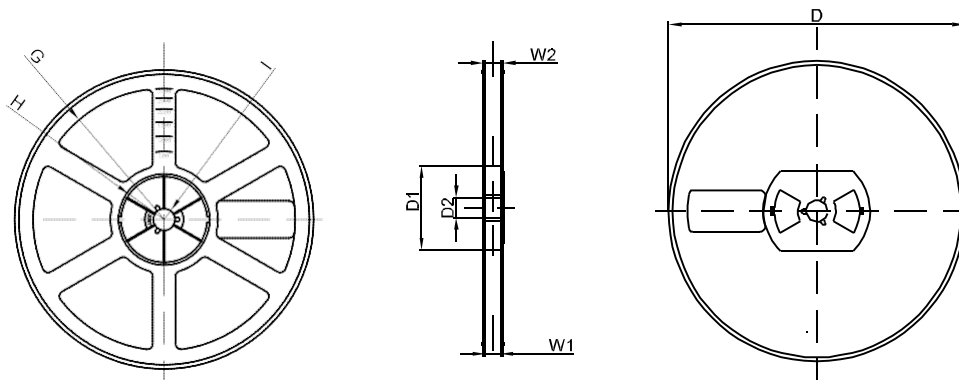

DIMENSIONS ARE IN MILLIMETER								
REEL OPTION	D	D1	D2	G	H	I	W1	W2
7" DIA	Ø178	54.40	13.00	R78	R25.60	R6.50	9.50	12.30
TOLERANCE	±2	±1	±1	±1	±1	±1	±1	±1