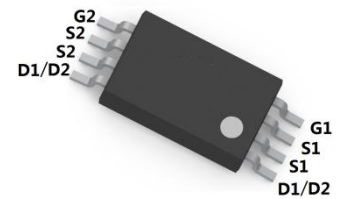
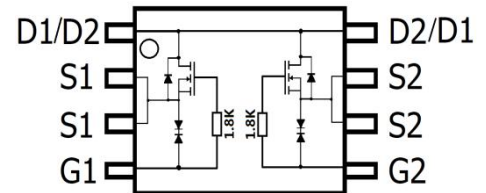

DUAL N-CHANNEL ENHANCEMENT MODE FET

FEATURES

- Ultra low on-resistance: $V_{DS}=20V, I_D=7A, R_{DS(ON)} \leq 20m\Omega @ V_{GS}=4.5V$
- Low gate charge
- ESD protected
- Surface Mount device

TSSOP-8

MECHANICAL DATA

- Case: TSSOP-8
- Case Material: Molded Plastic. UL flammability
- Classification Rating: 94V-0
- Weight: not available

MAXIMUM RATINGS ($T_A = 25^\circ\text{C}$ unless otherwise noted)

Parameter	Symbol	Value	Unit
Drain-source voltage	V_{DS}	20	V
Gate-source voltage	V_{GS}	± 8	V
Continuous drain current	I_D	$T_A = 25^\circ\text{C}$	7
		$T_A = 70^\circ\text{C}$	5.7
Pulsed drain current	I_{DM}	25	A
Power dissipation	P_D	$T_A = 25^\circ\text{C}$	1.5
		$T_A = 70^\circ\text{C}$	1
Thermal resistance from Junction to ambient	$R_{\theta JA}$	120	$^\circ\text{C/W}$
Thermal resistance from Junction to Lead	$R_{\theta JL}$	70	$^\circ\text{C/W}$
Junction temperature	T_J	150	$^\circ\text{C}$
Storage temperature	T_{STG}	-55 ~ +150	$^\circ\text{C}$

ELECTRICAL CHARACTERISTICS ($T_A = 25^\circ\text{C}$ unless otherwise specified)

Parameter	Symbol	Min	Typ	Max	Unit	Conditions
Drain-Source breakdown voltage	$V_{(BR)DSS}^*$	20			V	$V_{GS}=0V, I_D=250\mu A$
Zero gate voltage drain current	I_{DSS}^*			1	μA	$V_{DS}=20V, V_{GS}=0V$
Gate-body leakage current	I_{GSS}^*			± 10	μA	$V_{DS}=0V, V_{GS}=\pm 8V$
Gate-threshold voltage	$V_{GS(th)}^*$	0.4	0.7	1.1	V	$V_{DS}=V_{GS}, I_D=250\mu A$
On-State Drain Current	$I_{D(ON)}^*$	25			A	$V_{DS}=5V, V_{GS}=4.5V$
Drain-source on-resistance	$R_{DS(ON)}^*$		16	20	$m\Omega$	$V_{GS}=4.5V, I_D=7A$
			22	30	$m\Omega$	$V_{GS}=4.5V, I_D=7A, T_J=125^\circ\text{C}$
			16.2	20.5	$m\Omega$	$V_{GS}=4.0V, I_D=7A$
			17	21.5	$m\Omega$	$V_{GS}=3.1V, I_D=6.5A$
			18	23	$m\Omega$	$V_{GS}=2.5V, I_D=6.5A$
	21	28	$m\Omega$	$V_{GS}=1.8V, I_D=5A$		
Forward transconductance	g_{FS}		50		S	$V_{DS}=5V, I_D=7A$
Diode forward voltage	V_{SD}		0.62	1	V	$I_S=1A, V_{GS}=0V$
Diode forward current	I_S			2	A	
Input capacitance	C_{iss}		1295		pF	
Output capacitance	C_{oss}		160		pF	$V_{DS}=10V, V_{GS}=0V, f=1\text{MHz}$
Reverse transfer capacitance	C_{rss}		87		pF	
Gate resistance	R_g		1.8		$K\Omega$	$V_{DS}=0V, V_{GS}=0V, f=1\text{MHz}$
Total gate charge	Q_g		10	14	nC	
Gate-source charge	Q_{gs}		4.2		nC	$V_{GS}=4.5V, V_{DS}=10V, I_D=7A$
Gate-drain charge	Q_{gd}		2.6		nC	
Turn-on delay time	$t_{d(on)}$		280		nS	
Turn-on rise time	t_r		328		nS	$V_{GS}=4.5V, V_{DS}=10V,$
Turn-off delay time	$t_{d(off)}$		3.76		nS	$R_{GEN}=3\Omega, R_L=1.54\Omega$
Turn-off fall time	t_f		2.24		nS	
Body Diode Reverse Recovery Time	t_{rr}		31		nS	$I_F=7A, di/dt=100A/\mu S, V_{GS}=9V$
Body Diode Reverse Recovery Charge	Q_{rr}		6.8		nC	$I_F=7A, di/dt=100A/\mu S, V_{GS}=9V$

*Pulse test ; Pulse width $\leq 300\mu s$, Duty cycle $\leq 0.5\%$.

DUAL N-CHANNEL ENHANCEMENT MODE FET

TYPICAL ELECTRICAL AND THERMAL CHARACTERISTICS

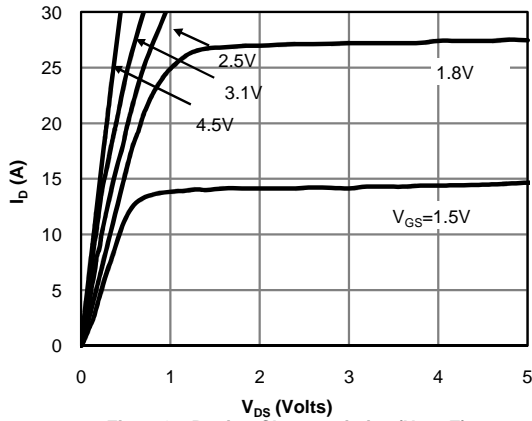

Fig 1: On-Region Characteristics (Note E)

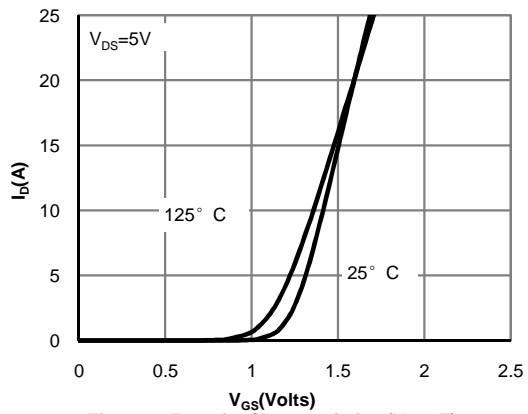

Figure 2: Transfer Characteristics (Note E)

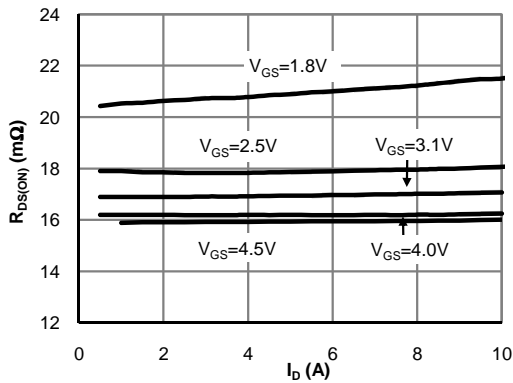

Figure 3: On-Resistance vs. Drain Current and Gate Voltage (Note E)

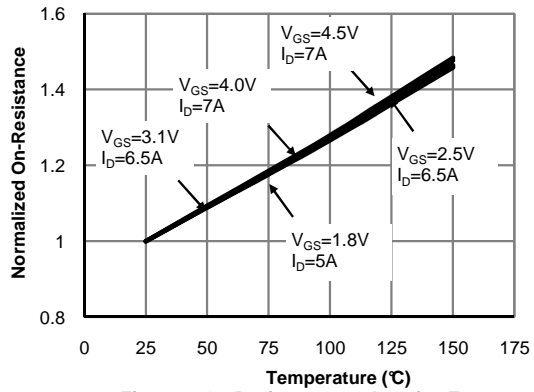

Figure 4: On-Resistance vs. Junction Temperature (Note E)

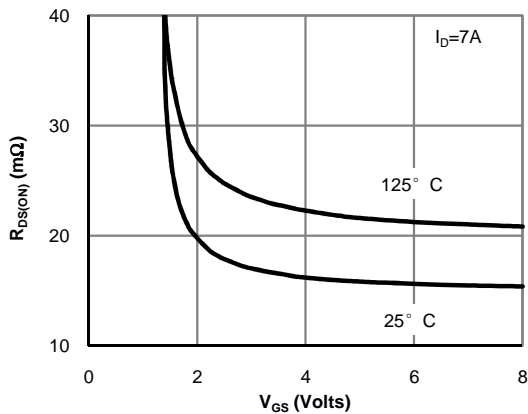

Figure 5: On-Resistance vs. Gate-Source Voltage (Note E)

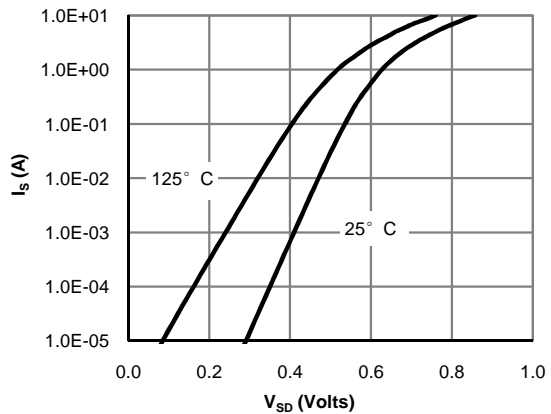

Figure 6: Body-Diode Characteristics (Note E)

DUAL N-CHANNEL ENHANCEMENT MODE FET

TYPICAL ELECTRICAL AND THERMAL CHARACTERISTICS

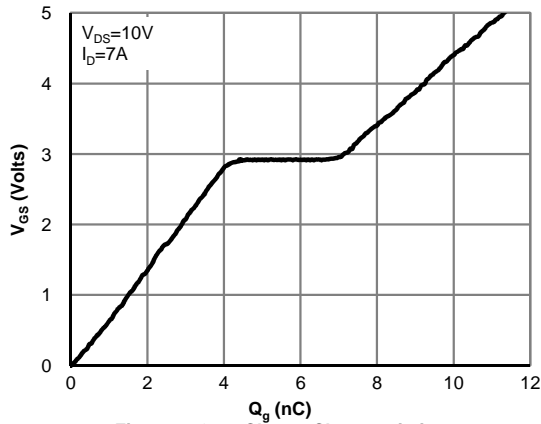

Figure 7: Gate-Charge Characteristics

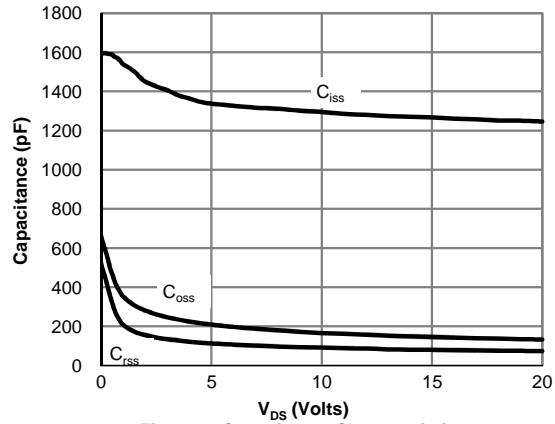

Figure 8: Capacitance Characteristics

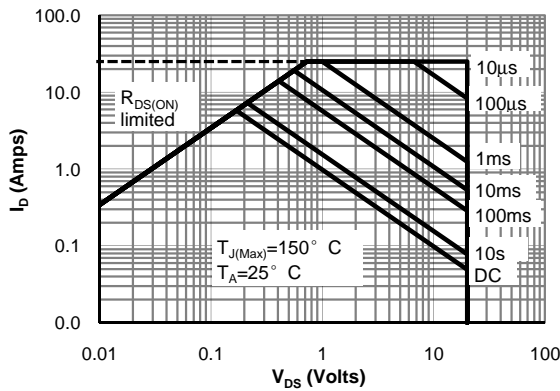

Figure 9: Maximum Forward Biased Safe Operating Area

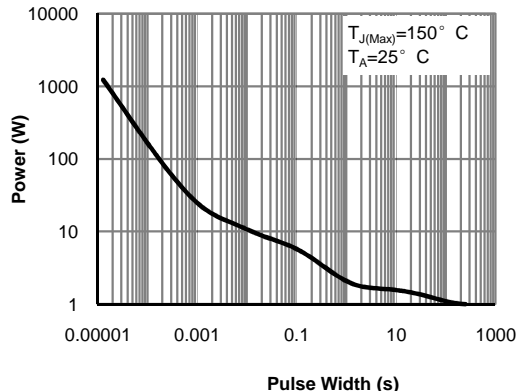

Figure 10: Single Pulse Power Rating Junction-to-Ambient

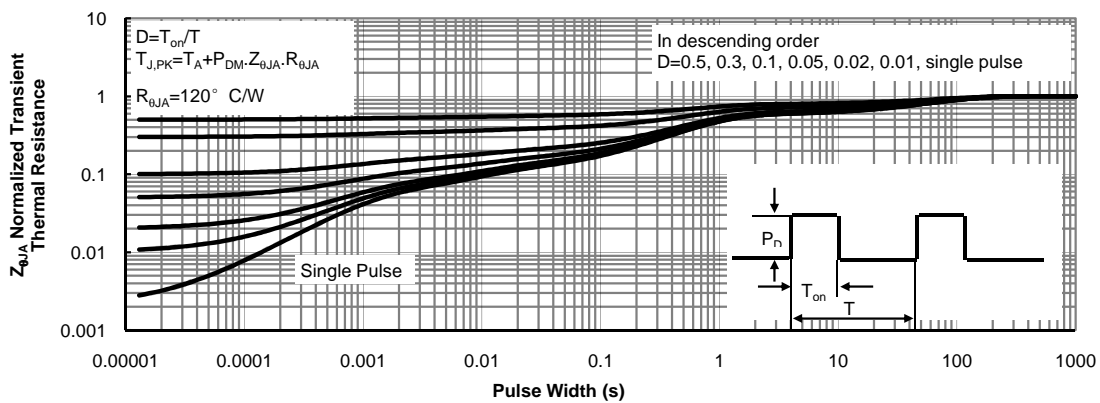
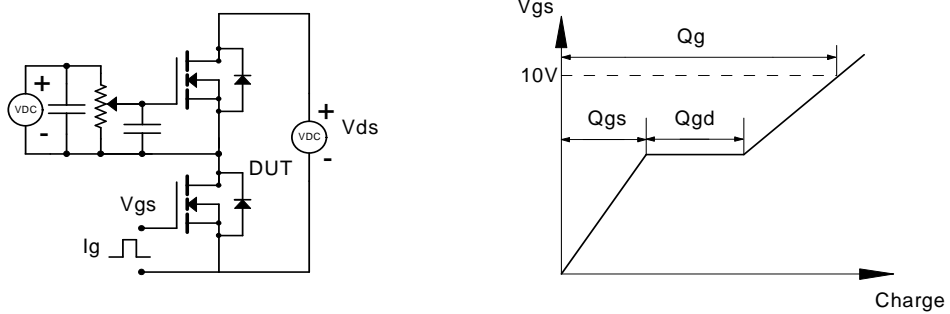

Figure 11: Normalized Maximum Transient Thermal Impedance

DUAL N-CHANNEL ENHANCEMENT MODE FET

Gate Charge Test Circuit & Waveform



Resistive Switching Test Circuit & Waveforms

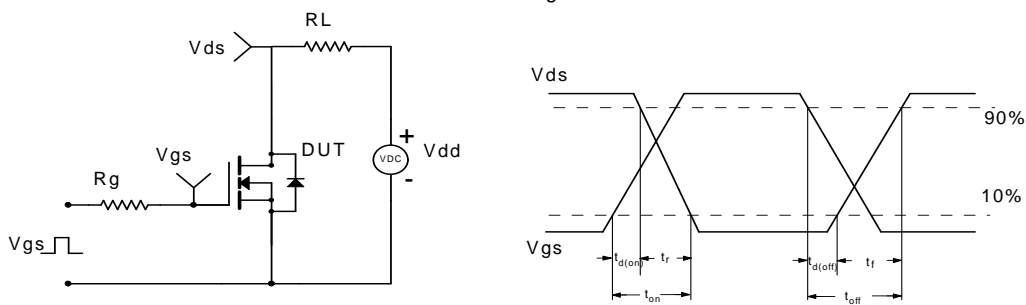

Diode Recovery Test Circuit & Waveforms

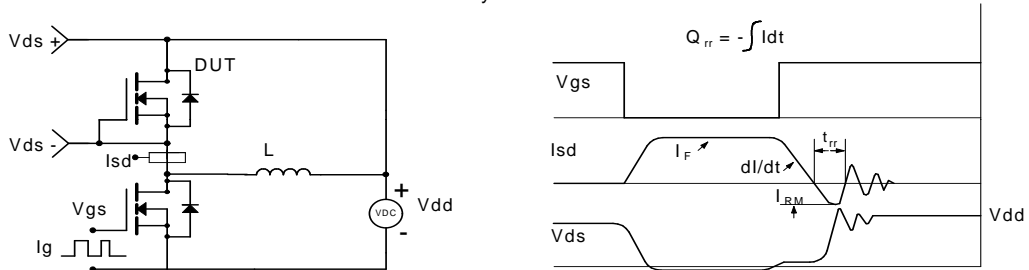

DUAL N-CHANNEL ENHANCEMENT MODE FET

SOP-8 Package Outline Dimensions

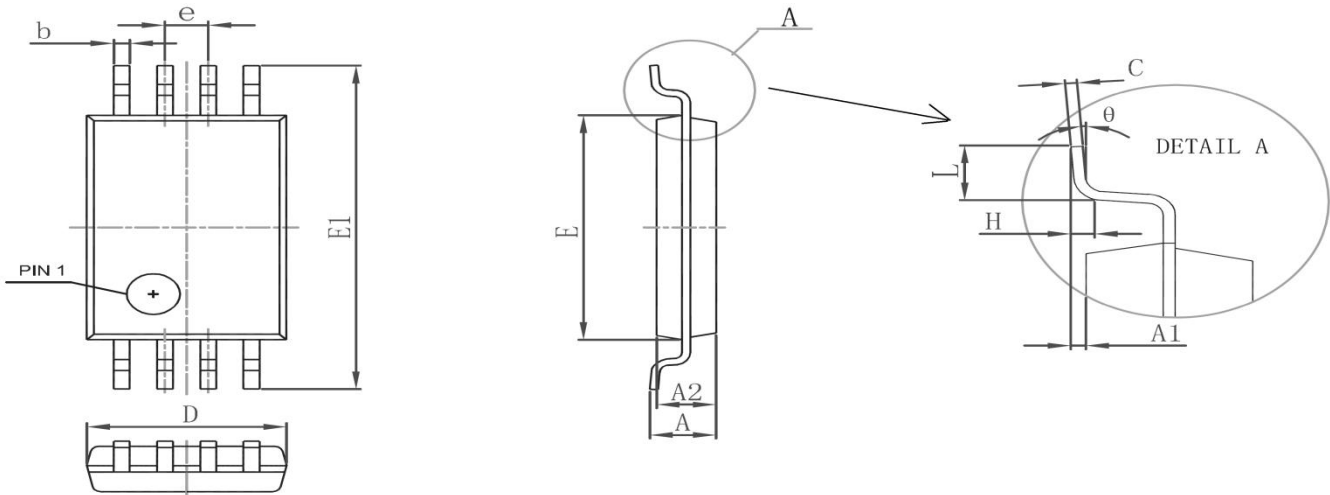

Symbol	Dimensions In Millimeters		Dimensions In Inches	
	Min.	Max.	Min.	Max.
D	2.900	3.100	0.114	0.122
E	4.300	4.500	0.169	0.177
b	0.190	0.300	0.007	0.012
c	0.090	0.200	0.004	0.008
E1	6.250	6.550	0.246	0.258
A		1.200		0.047
A2	0.800	1.000	0.031	0.039
A1	0.050	0.150	0.002	0.006
e	0.65(BSC)		0.026(BSC)	
L	0.500	0.700	0.020	0.028
H	0.25(TYP)		0.01(TYP)	
θ	1°	7°	1°	7°

SOP-8 Suggested Pad Layout

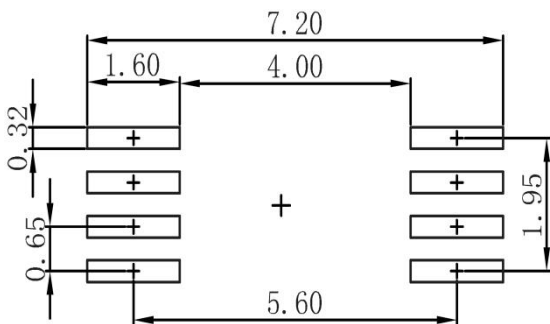

Note:

1. Controlling dimension: in millimeters
2. General tolerance: ±0.05mm
3. The pad layout is for reference purposes only

DUAL N-CHANNEL ENHANCEMENT MODE FET

SOP-8 Tape and Reel

SOP-8 Embossed Carrier Tape

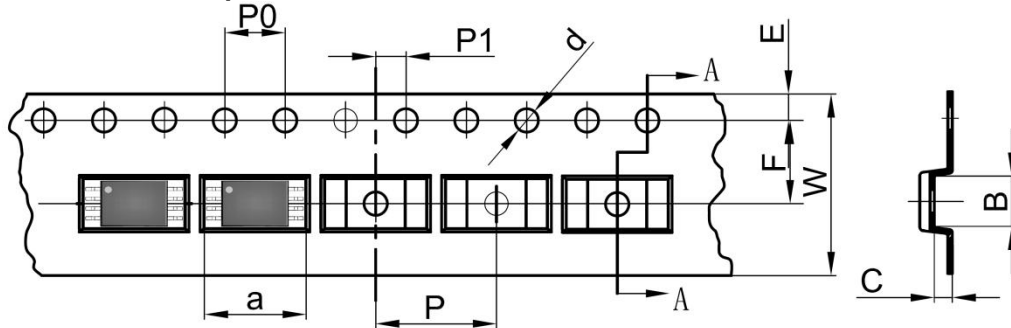

DIMENSIONS ARE IN MILLIMETER										
TYPE	a	B	C	d	E	F	P0	P	P1	W
SOP-8	6.76	3.30	1.20	Ø1.50	1.75	5.50	4.00	8.00	2.00	12.00
TOLERANCE	±0.1	±0.1	±0.1	±0.1	±0.1	±0.1	±0.1	±0.1	±0.1	±0.1

SOP-8 Tape Leader and Trailer

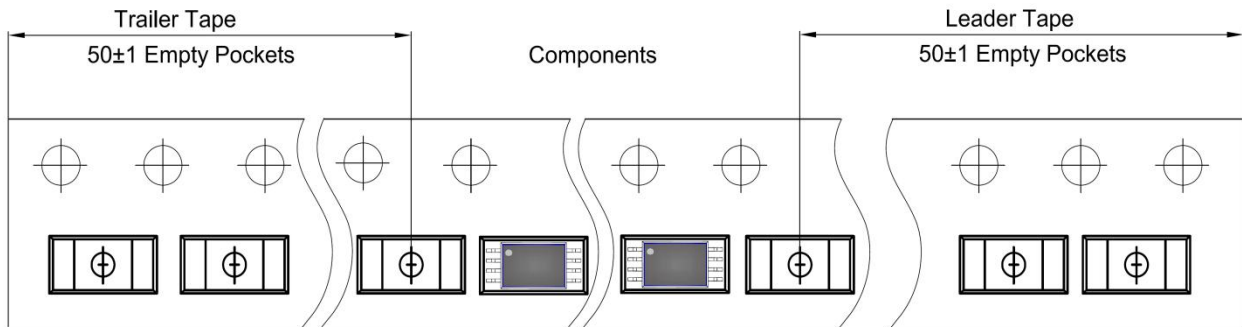

SOP-8 Reel

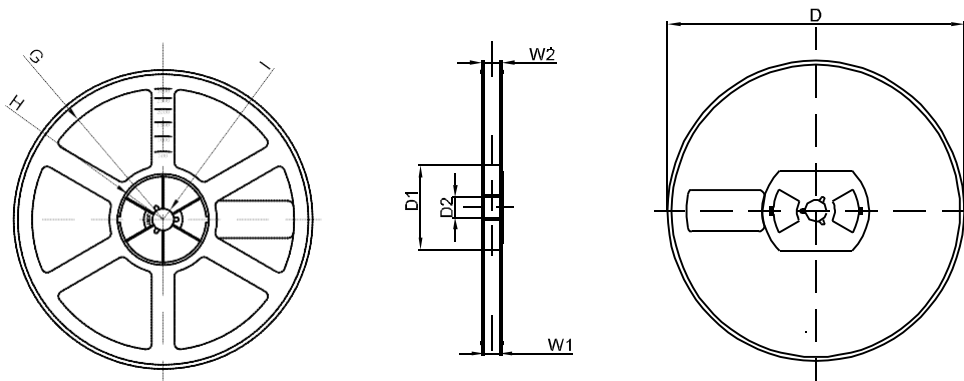

DIMENSIONS ARE IN MILLIMETER								
REEL OPTION	D	D1	D2	G	H	I	W1	W2
13" DIA	Ø330.00	100.00	13.00	R151.00	R56.00	R6.50	12.40	17.60
TOLERANCE	±2	±1	±1	±1	±1	±1	±1	±1