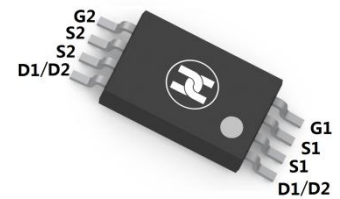
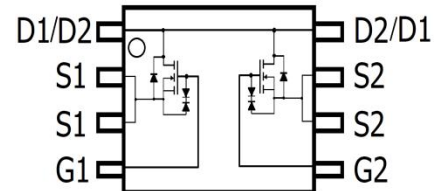

DUAL N-CANNEL ENHANCEMENT MODE FET

FEATURES

- Ultra low on-resistance: $V_{DS}=20V, I_D=7A, R_{DS(ON)} \leq 21m\Omega @ V_{GS}=10V$
- Low gate charge
- ESD protected
- Surface Mount device

TSSOP-8

MECHANICAL DATA

- Case: TSSOP-8
- Case Material: Molded Plastic. UL flammability
- Classification Rating: 94V-0
- Weight: not available

MAXIMUM RATINGS ($T_A = 25^\circ\text{C}$ unless otherwise noted)

Parameter	Symbol	Value	Unit
Drain-source voltage	V_{DS}	20	V
Gate-source voltage	V_{GS}	± 12	V
Continuous drain current	I_D	$T_A = 25^\circ\text{C}$	7
		$T_A = 70^\circ\text{C}$	5.5
Pulsed drain current	I_{DM}	25	A
Power dissipation	P_D	$T_A = 25^\circ\text{C}$	1.5
		$T_A = 70^\circ\text{C}$	0.96
Thermal resistance from Junction to ambient	$R_{\theta JA}$	120	$^\circ\text{C/W}$
Thermal resistance from Junction to Lead	$R_{\theta JL}$	70	$^\circ\text{C/W}$
Junction temperature	T_J	150	$^\circ\text{C}$
Storage temperature	T_{STG}	-55 ~ +150	$^\circ\text{C}$

ELECTRICAL CHARACTERISTICS ($T_A = 25^\circ\text{C}$ unless otherwise specified)

Parameter	Symbol	Min	Typ	Max	Unit	Conditions
Drain-Source breakdown voltage	$V_{(BR)DSS}^*$	20			V	$V_{GS}=0V, I_D=250\mu A$
Zero gate voltage drain current	I_{DSS}^*			1	μA	$V_{DS}=16V, V_{GS}=0V$
Gate-body leakage current	I_{GSS}^*			± 10	μA	$V_{DS}=0V, V_{GS}=\pm 10V$
						± 12
Gate-threshold voltage	$V_{GS(th)}^*$	0.5	0.65	1	V	$V_{DS}=V_{GS}, I_D=250\mu A$
On-State Drain Current	$I_{D(ON)}^*$	25			A	$V_{DS}=5V, V_{GS}=4.5V$
Drain-source on-resistance	$R_{DS(ON)}^*$		16.5	21	$m\Omega$	$V_{GS}=10V, I_D=7A$
			23.1		$m\Omega$	$V_{GS}=10V, I_D=7A, T_J=125^\circ\text{C}$
			19	24	$m\Omega$	$V_{GS}=4.5V, I_D=6.6A$
			25	32	$m\Omega$	$V_{GS}=2.5V, I_D=5.5A$
			35	50	$m\Omega$	$V_{GS}=1.8V, I_D=2A$
Forward transconductance	g_{FS}		25		S	$V_{DS}=5V, I_D=7A$
Diode forward voltage	V_{SD}		0.75	1	V	$I_S=1A, V_{GS}=0V$
Diode forward current	I_S		2.5		A	
Input capacitance	C_{iss}		615		pF	$V_{DS}=10V, V_{GS}=0V, f=1\text{MHz}$
Output capacitance	C_{oss}		150		pF	
Reverse transfer capacitance	C_{rss}		120		pF	
Gate resistance	R_g		0.9		Ω	
Total gate charge	Q_g		8.5	12	nC	$V_{GS}=4.5V, V_{DS}=10V, I_D=7A$
Gate-source charge	Q_{gs}		1.2		nC	
Gate-drain charge	Q_{gd}		3		nC	
Turn-on delay time	$t_{d(on)}$		7		μS	$V_{GS}=5V, V_{DS}=10V, R_{GEN}=3\Omega, R_L=1.4\Omega$
Turn-on rise time	t_r		13		μS	
Turn-off delay time	$t_{d(off)}$		29		μS	
Turn-off fall time	t_f		11		μS	
Body Diode Reverse Recovery Time	t_{rr}		15		nS	
Body Diode Reverse Recovery Charge	Q_{rr}		5		nC	$I_F=7A, di/dt=100A/\mu S$

*Pulse test ; Pulse width $\leq 300\mu s$, Duty cycle $\leq 0.5\%$.

DUAL N-CHANNEL ENHANCEMENT MODE FET

TYPICAL ELECTRICAL AND THERMAL CHARACTERISTICS

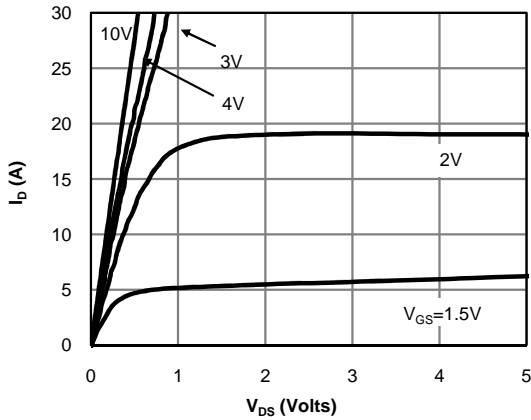

Fig 1: On-Region Characteristics

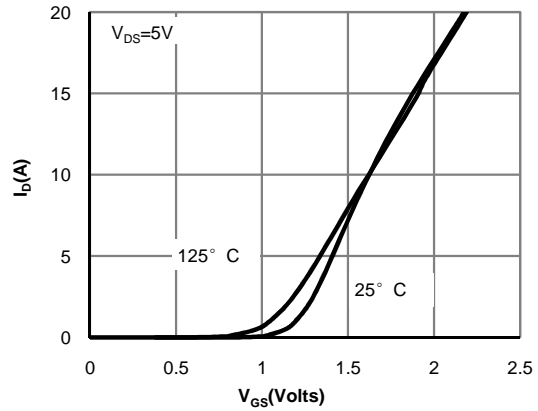

Figure 2: Transfer Characteristics

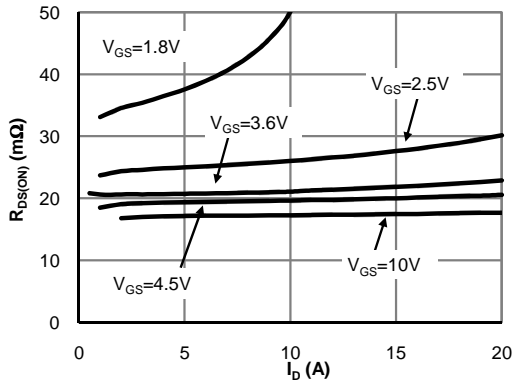

Figure 3: On-Resistance vs. Drain Current and Gate Voltage

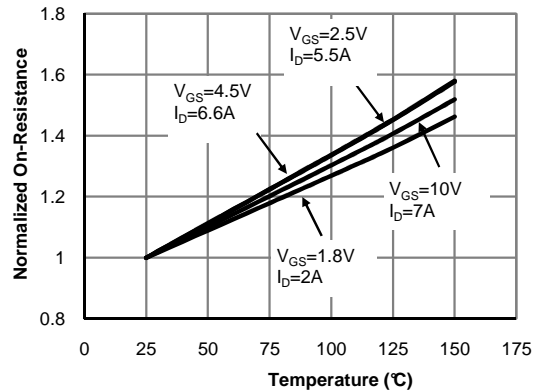

Figure 4: On-Resistance vs. Junction Temperature

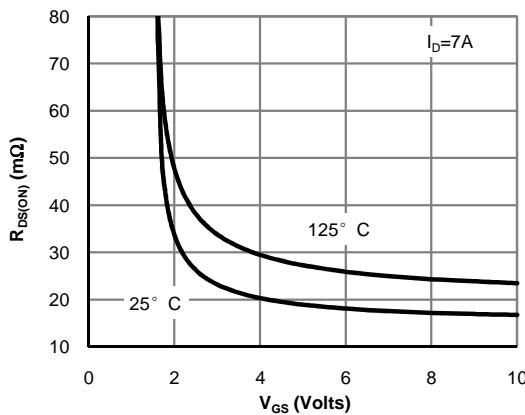

Figure 5: On-Resistance vs. Gate-Source Voltage

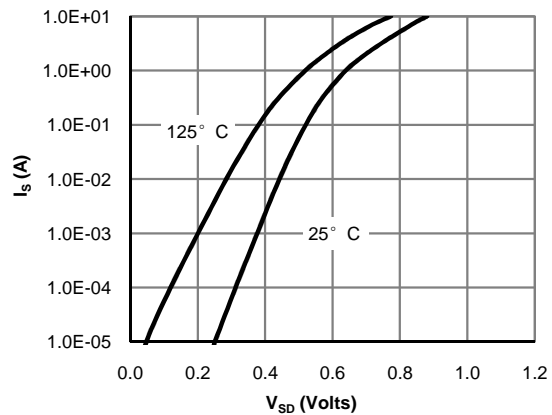

Figure 6: Body-Diode Characteristics

DUAL N-CHANNEL ENHANCEMENT MODE FET

TYPICAL ELECTRICAL AND THERMAL CHARACTERISTICS

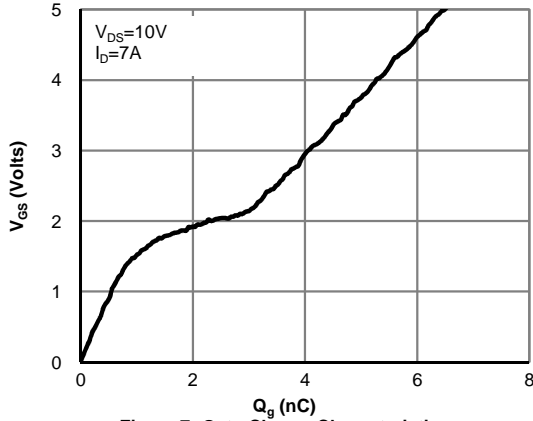

Figure 7: Gate-Charge Characteristics

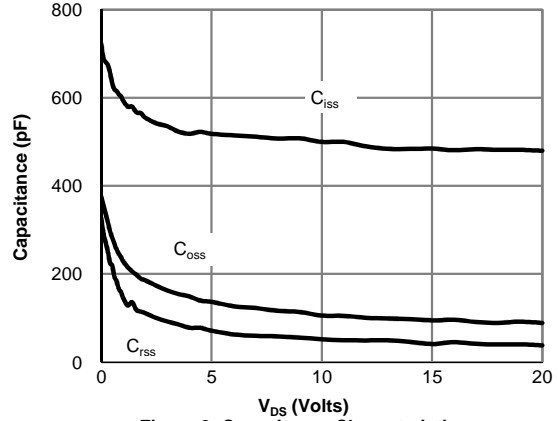

Figure 8: Capacitance Characteristics

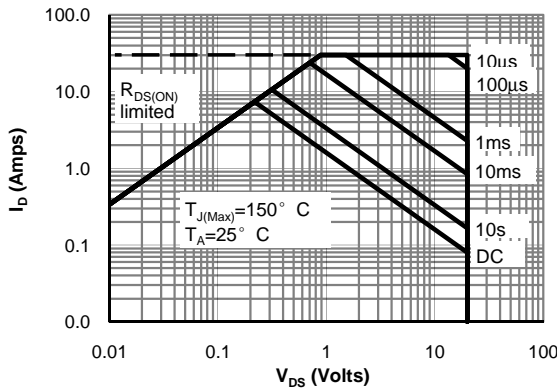

Figure 9: Maximum Forward Biased Safe Operating Area

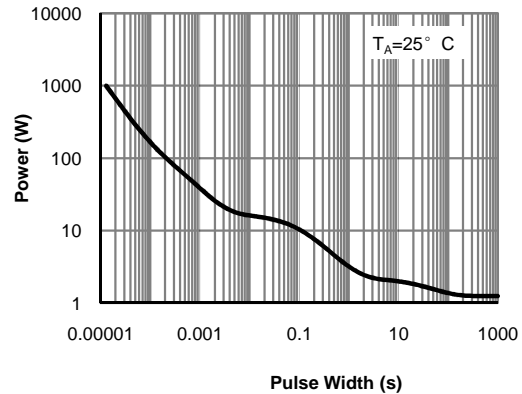

Figure 10: Single Pulse Power Rating Junction-to-Ambient

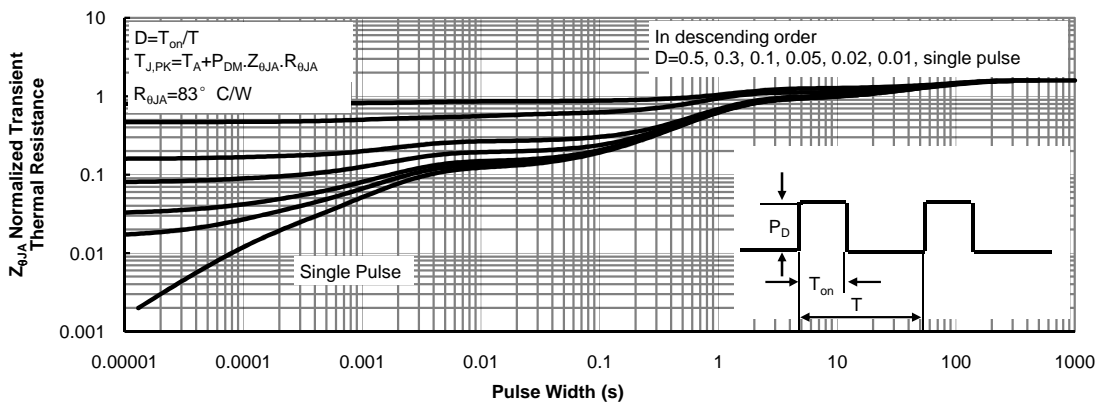
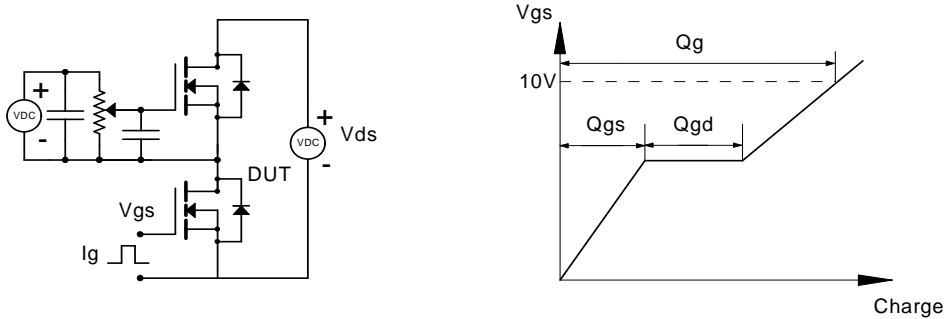

Figure 11: Normalized Maximum Transient Thermal Impedance

DUAL N-CHANNEL ENHANCEMENT MODE FET

Gate Charge Test Circuit & Waveform



Resistive Switching Test Circuit & Waveforms

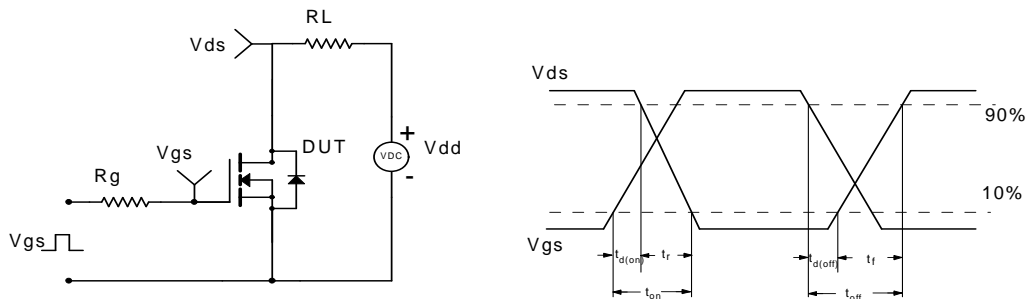

Diode Recovery Test Circuit & Waveforms

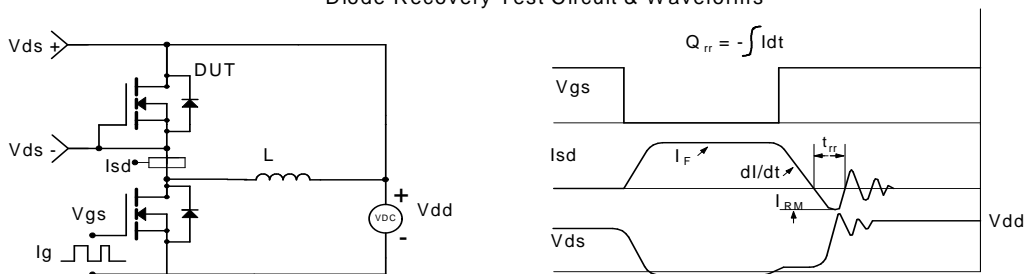

DUAL N-CHANNEL ENHANCEMENT MODE FET

TSSOP-8 Package Outline Dimensions

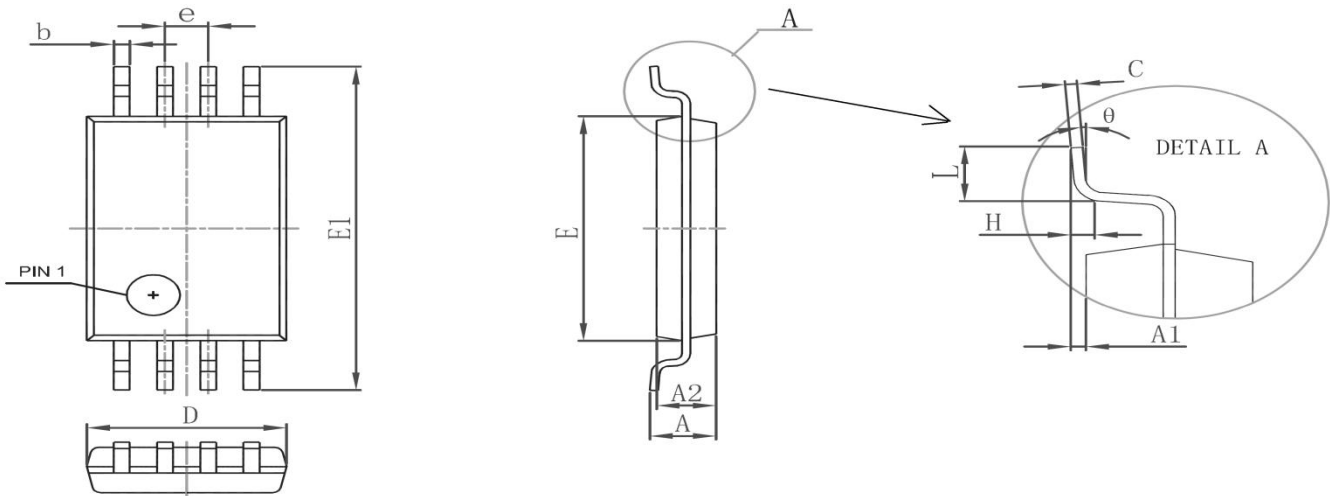

Symbol	Dimensions In Millimeters		Dimensions In Inches	
	Min.	Max.	Min.	Max.
D	2.900	3.100	0.114	0.122
E	4.300	4.500	0.169	0.177
b	0.190	0.300	0.007	0.012
c	0.090	0.200	0.004	0.008
E1	6.250	6.550	0.246	0.258
A		1.200		0.047
A2	0.800	1.000	0.031	0.039
A1	0.050	0.150	0.002	0.006
e	0.65(BSC)		0.026(BSC)	
L	0.500	0.700	0.020	0.028
H	0.25(TYP)		0.01(TYP)	
θ	1°	7°	1°	7°

TSSOP-8 Suggested Pad Layout

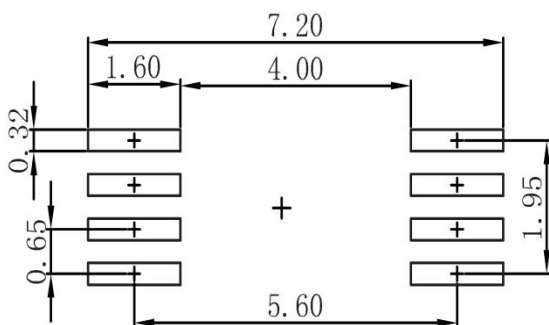

Note:

1. Controlling dimension: in millimeters
2. General tolerance: ±0.05mm
3. The pad layout is for reference purposes only

DUAL N-CHANNEL ENHANCEMENT MODE FET

TSSOP-8 Tape and Reel

TSSOP-8 Embossed Carrier Tape

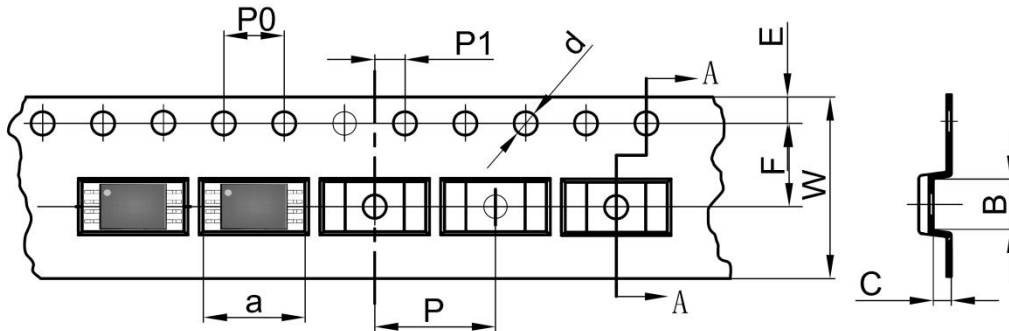

DIMENSIONS ARE IN MILLIMETER										
TYPE	a	B	C	d	E	F	P0	P	P1	W
TSSOP-8	6.76	3.30	1.20	Ø1.50	1.75	5.50	4.00	8.00	2.00	12.00
TOLERANCE	±0.1	±0.1	±0.1	±0.1	±0.1	±0.1	±0.1	±0.1	±0.1	±0.1

TSSOP-8 Tape Leader and Trailer

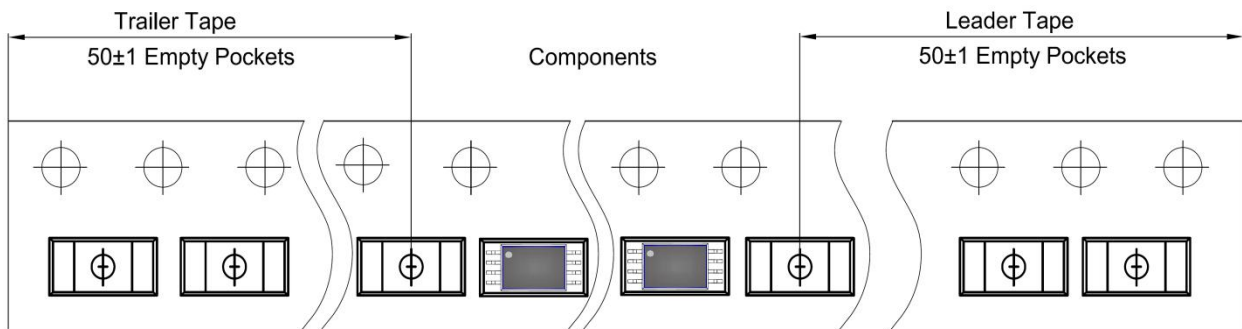

TSSOP-8 Reel

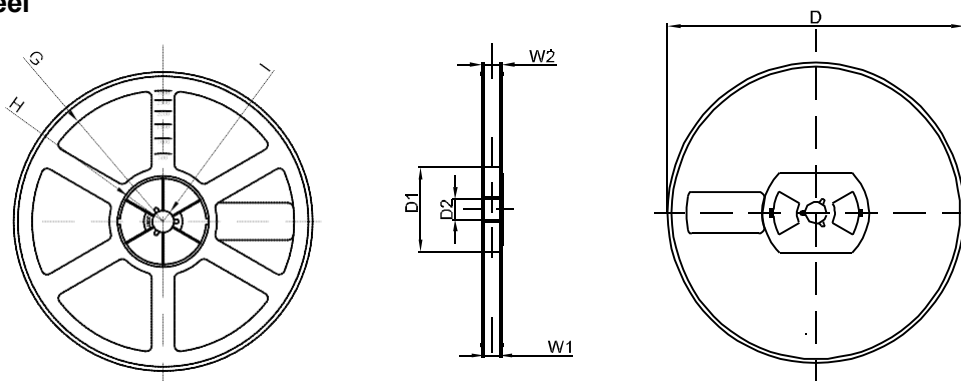

DIMENSIONS ARE IN MILLIMETER								
REEL OPTION	D	D1	D2	G	H	I	W1	W2
13" DIA	Ø330.00	100.00	13.00	R151.00	R56.00	R6.50	12.40	17.60
TOLERANCE	±2	±1	±1	±1	±1	±1	±1	±1