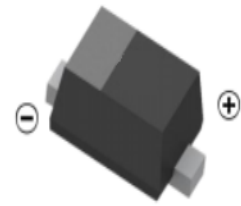
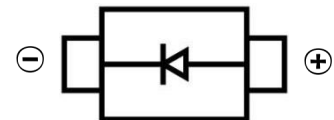

SCHOTTKY BARRIER DIODE
FEATURES

- Low Forward Voltage Drop;
- Guard Ring Construction for Transient Protection;
- Small Surface Mount device
- Low Reverse Capacitance;
- Low Reverse Recover Time;

SOD-523
Marking: S4
MECHANICAL DATA

- Case: SOD-523
- Case Material: Molded Plastic. UL flammability
- Classification Rating: 94V-0
- Weight: 0.005 grams (approximate)

MAXIMUM RATINGS (Ta=25°C unless otherwise noted)

Parameter	Symbol	Value	Unit
Peak Repetitive Peak Reverse Voltage	V_{RRM}	40	V
Working Peak Reverse Voltage	V_{RWM}		
DC Blocking Voltage	V_R		
RMS Reverse Voltage	$V_{R(RMS)}$	28	V
Forward Continuous current	I_o	350	mA
Repetitive Peak Forward Current @ $t \leq 1S$	I_{FRM}	1	A
Non- Repetitive Peak Forward Surge Current @ $t \leq 8.3mS$ Half Sine Wave	I_{FSM}	15	A
Power Dissipation	P_d	150	mW
Thermal Resistance Junction To Ambient	$R_{\theta JA}$	667	°C/mW
Junction Temperature	T_{stg}	125	°C
Storage Temperature	T_{stg}	-55~150	°C

ELECTRIAL CHARACTERISTICS (Ta=25°C)

Parameter	Symbol	Test Conditions	Min	Typ	Max	Unit
Reverse Voltage	$V_{(BR)}$	$I_R=100 \mu A$	40			V
Reverse current	I_R	$V_R=30V$			5	u A
		$V_R=20V$			2	
		$V_R=30V$			5	
Forward Voltage	V_F	$I_F=1mA$		0.27		V
		$I_F=5mA$		0.32		
		$I_F=20mA$			0.37	
		$I_F=200mA$			0.6	
Diode Capacitance	C_D	$V_R=4V, f=1.0MHz$		50		pF
Recover Reverse Time	t_{rr}	$I_F=I_R=200mA, I_{rr}=0.1 \times I_R, R_L=100 \Omega$		10		nS

SCHOTTKY BARRIER DIODE

Typical Characteristics

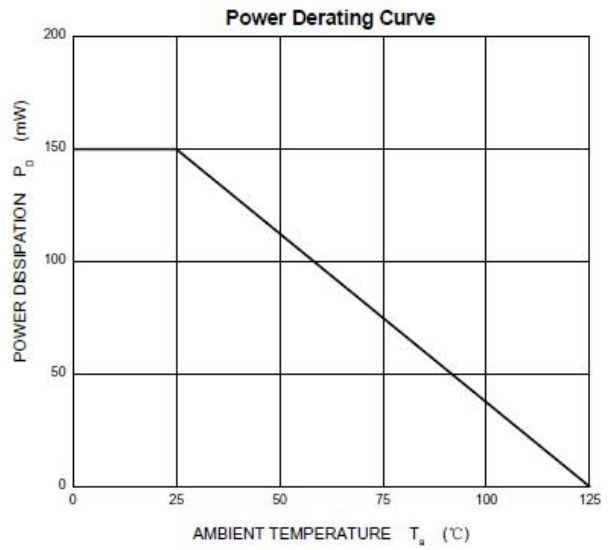
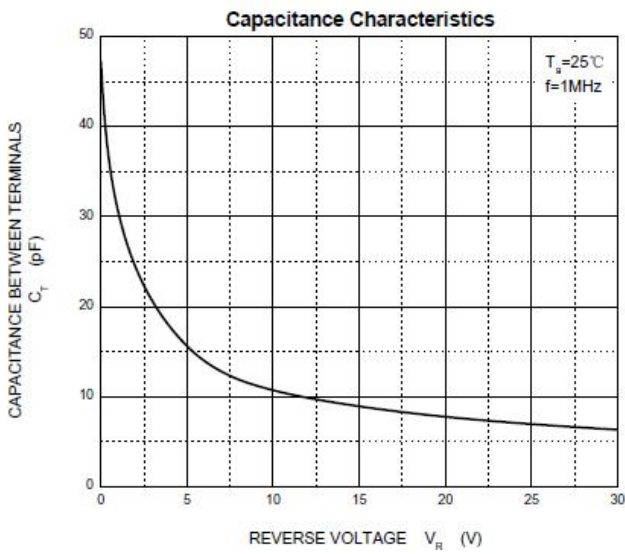
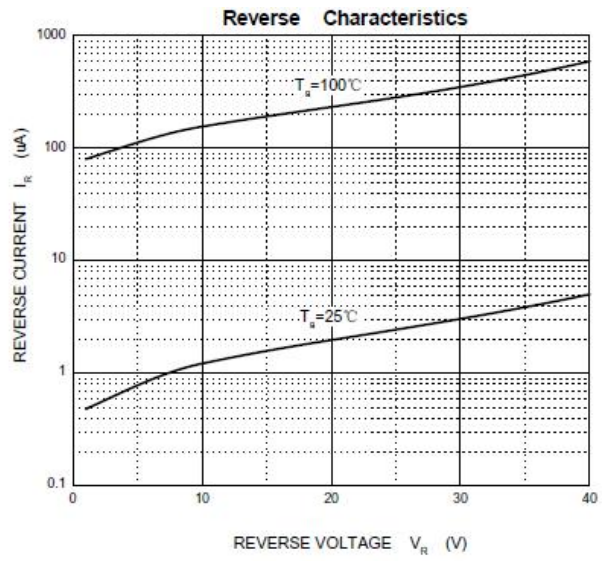
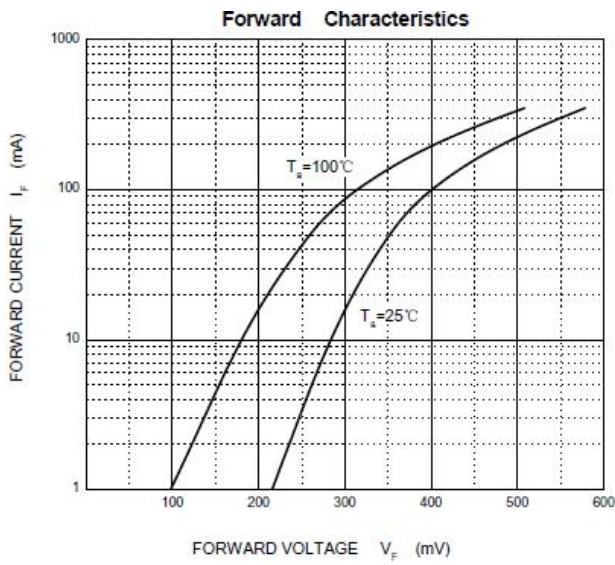

SCHOTTKY BARRIER DIODE

SOD-523 Package Outline Dimensions

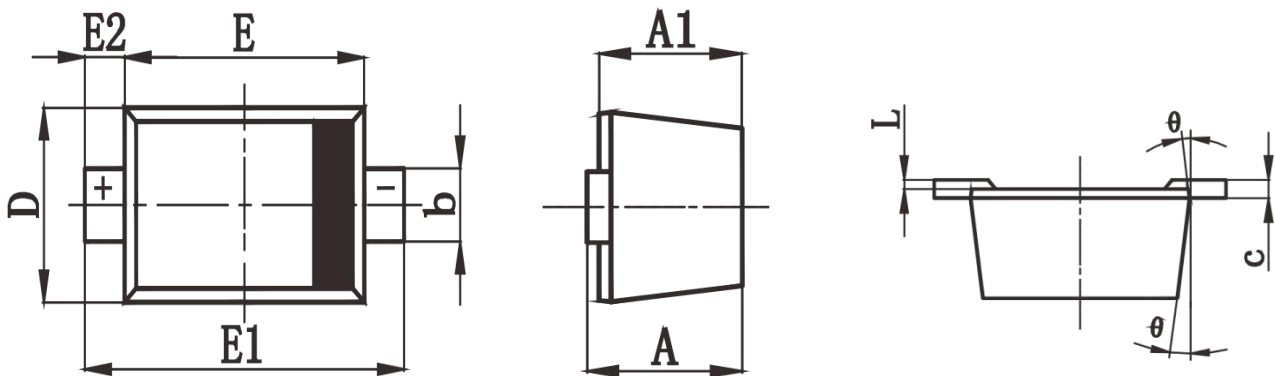

Symbol	Dimensions In Millimeters		Dimensions In Inches	
	Min.	Max.	Min.	Max.
A	0.510	0.770	0.020	0.031
A1	0.010	0.070	0.001	0.003
A2	0.500	0.700	0.020	0.028
b	0.250	0.350	0.010	0.014
c	0.080	0.150	0.003	0.006
D	0.750	0.850	0.030	0.033
E	1.100	1.300	0.043	0.051
E1	1.500	1.700	0.059	0.067
L	0.200 REF		0.008 REF	
L1	0.250	0.400	0.010	0.016
θ	0°	8°	0°	8°

SOD-523 Suggested Pad Layout

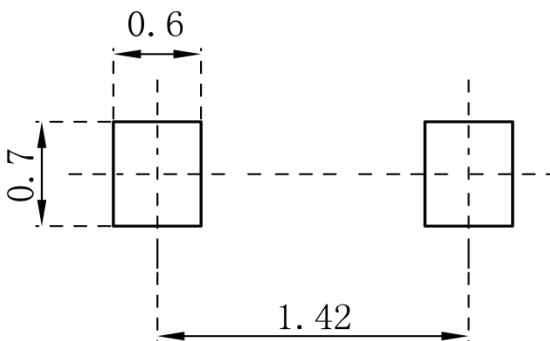

Note:

1. Controlling dimension: in millimeters
2. General tolerance: $\pm 0.05\text{mm}$
3. The pad layout is for reference purposes only

SCHOTTKY BARRIER DIODE

SOD-523 Tape and Reel

SOD-523 Embossed Carrier Tape

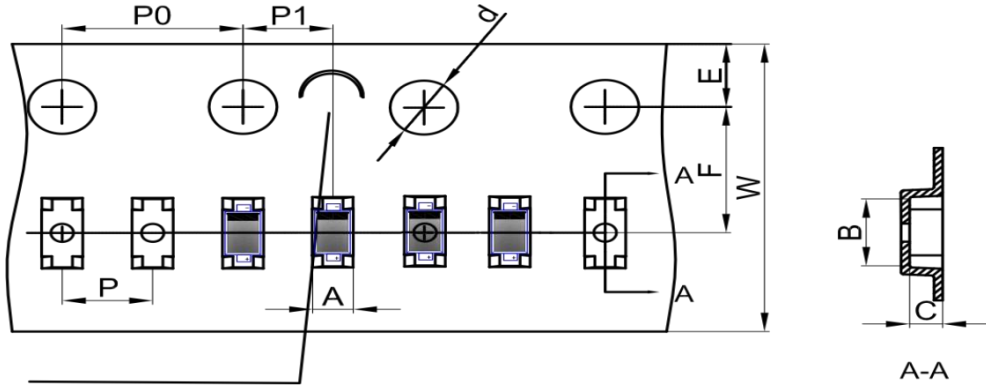

NOTE: TO CAVE 'C' ON CARRIER TAPE PER 120MM

DIMENSIONS ARE IN MILLIMETER										
TYPE	A	B	C	d	E	F	P0	P	P1	W
SOD-523	0.90	1.94	0.73	Ø1.50	1.75	3.50	4.00	2.00	2.00	8.00
TOLERANCE	±0.1	±0.1	±0.1	±0.1	±0.1	±0.1	±0.1	±0.1	±0.1	±0.1

SOD-523 Tape Leader and Trailer

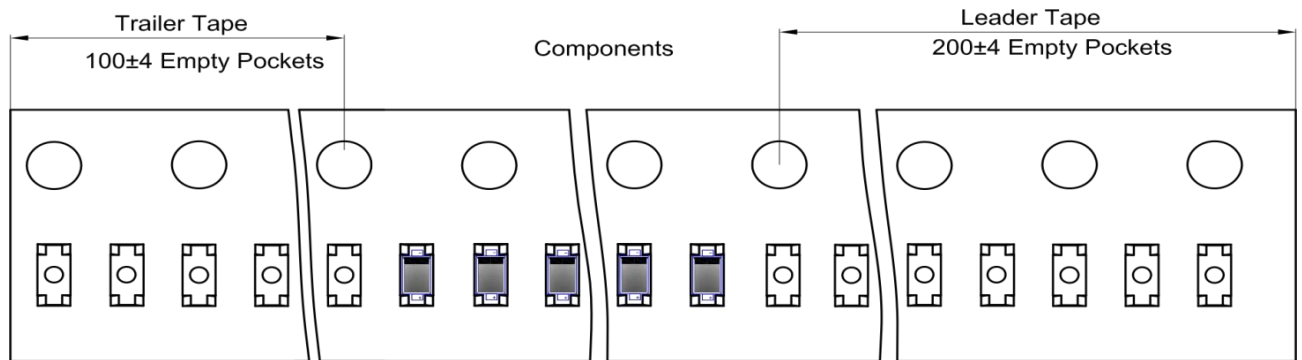

SOD-523 Reel

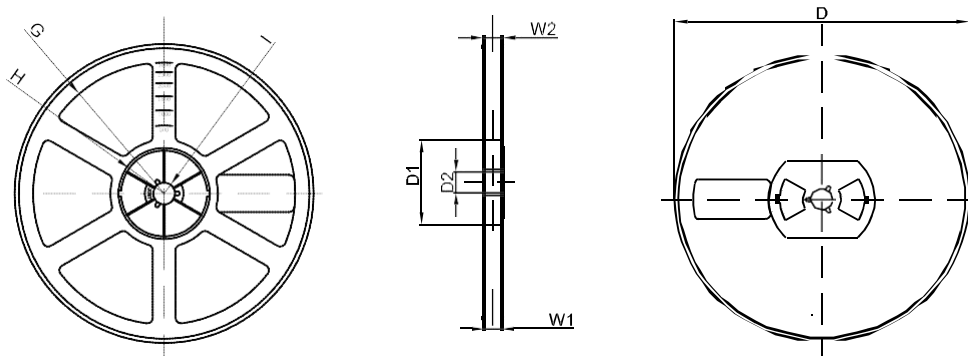

DIMENSIONS ARE IN MILLIMETER								
REEL OPTION	D	D1	D2	G	H	I	W1	W2
7" DIA	Ø178	54.40	13.00	R78	R25.60	R6.50	9.50	12.30
TOLERANCE	±2	±1	±1	±1	±1	±1	±1	±1