

SUPER FAST RECOVERY RECTIFIER DIODE

FEATURES

- Surface Mount device
- Low Reverse voltage leakage current
- Glass passivated junction
- High forward surge current capability
- Low forward voltage drop
- Super Fast Recovery Time for High Efficiency

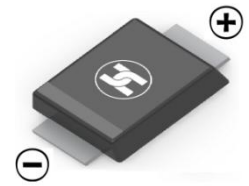

SMBF

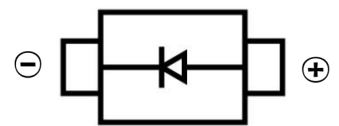

MECHANICAL DATA

- Case: SMBF
- Case Material: Molded Plastic. UL flammability
- Classification Rating: 94V-0
- Weight: 0.057 grams (approximate)

MAXIMUM RATINGS ($T_A = 25^\circ\text{C}$ unless otherwise noted)

Parameter	Symbol	Value	Unit
Maximum Recurrent Peak Reverse Voltage	V_{RRM}	50	V
DC Blocking Reverse Voltage	V_R	50	V
RMS Reverse Voltage	$V_{R(RMS)}$	35	V
Maximum Average Forward Rectified Current	I_F	1	A
Non-Repetitive Peak Forward Surge Current @ $t=8.3\text{ms}$	I_{FSM}	35	A
Thermal Resistance From Junction To Ambient	$R_{\theta JA}$	75	$^\circ\text{C}/\text{W}$
Reverse Recovery Time(@ $I_F=0.5\text{A}$, $I_R=1.0\text{A}$, $I_{RR}=0.25\text{A}$)	t_{rr}	35	nS
Junction Temperature	T_J	-55 ~+150	$^\circ\text{C}$
Storage Temperature	T_{STG}	-55 ~+150	$^\circ\text{C}$

ELECTRICAL CHARACTERISTICS ($T_A = 25^\circ\text{C}$ unless otherwise specified)

Parameter	Symbol	Min	Typ	Max	Unit	Conditions
Forward voltage	V_F			1.0	V	$I_F=1\text{A}$
Reverse current @ $T_A=25^\circ\text{C}$	I_R			5	μA	$V_R=50\text{V}$
Reverse current @ $T_A=125^\circ\text{C}$	I_R			100	μA	$V_R=50\text{V}$
Diode capacitance	C_D		15		pF	$V_R=4V_{DC}$, $f=1\text{MHz}$

SUPER FAST RECOVERY RECTIFIER DIODE

Typical Characteristics

Fig.1 Reverse Recovery Time Characteristic And Test Circuit Diagram

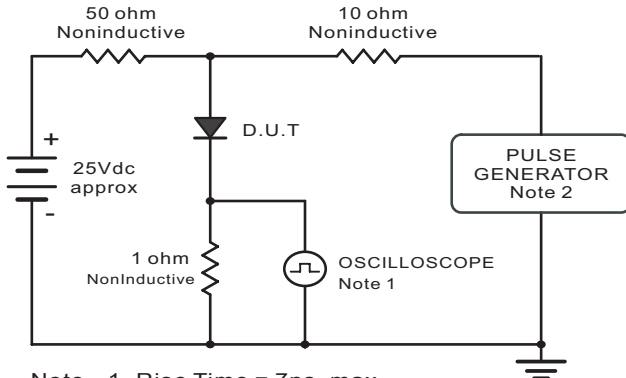

Note: 1. Rise Time = 7ns, max.
Input Impedance = 1megohm, 22pF.
2. Rise Time = 10ns, max.
Source Impedance = 50 ohms.

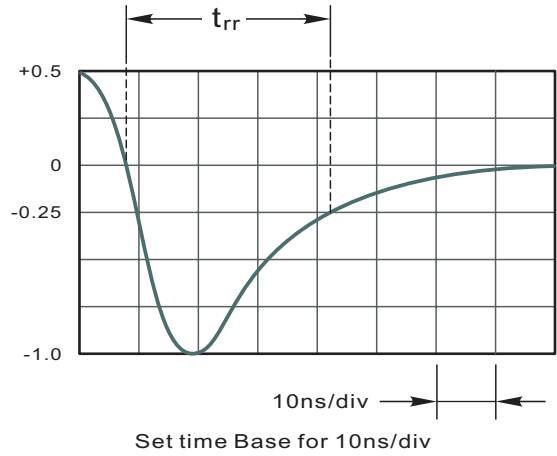

Fig.2 Maximum Average Forward Current Rating

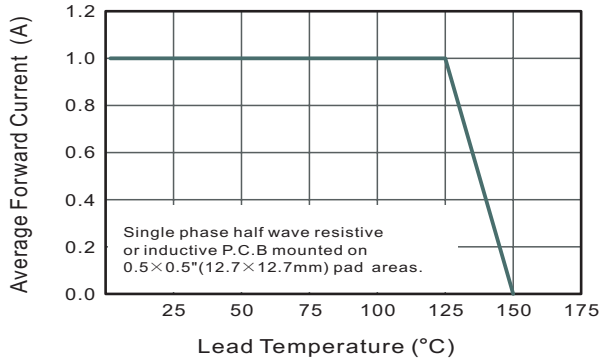

Fig.3 Typical Reverse Characteristics

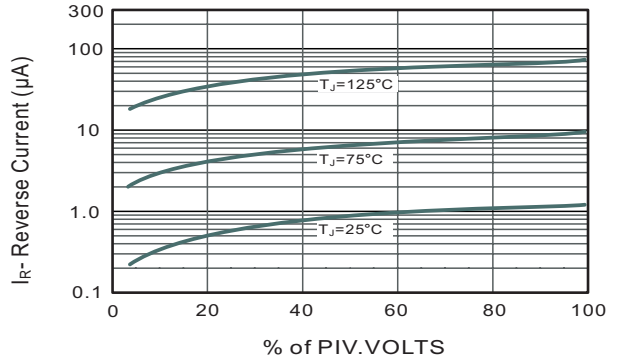

Fig.4 Typical Forward Characteristics

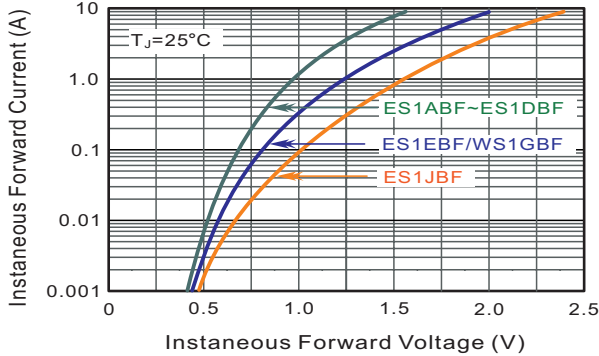

Fig.5 Typical Junction Capacitance

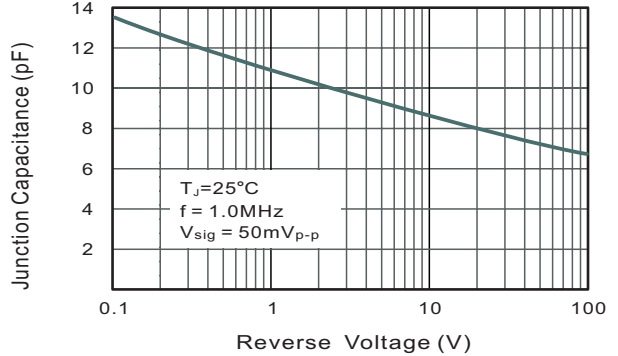
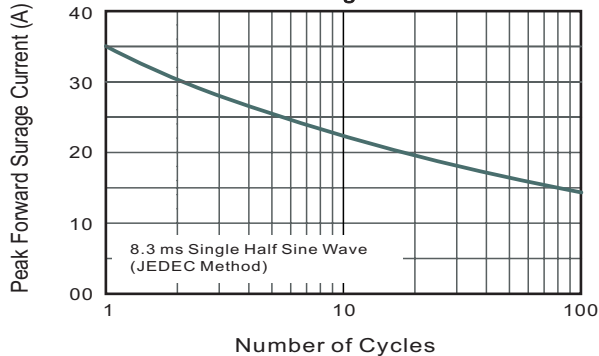
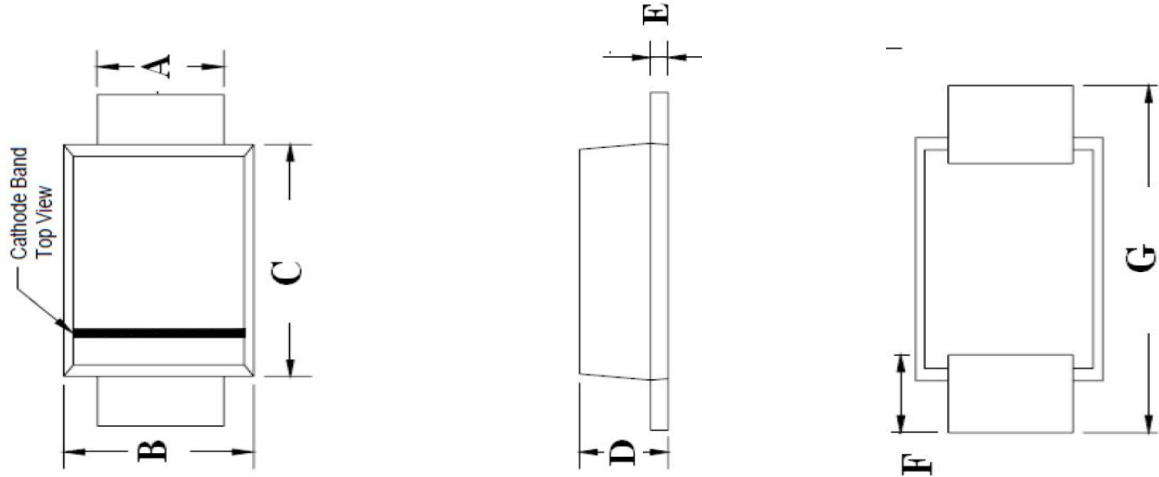

Fig.4 Maximum Non-Repetitive Peak Forward Surge Current



SUPER FAST RECOVERY RECTIFIER DIODE

SMBF Package Outline Dimensions



Symbol	Dimensions In Millimeters		Dimensions In Inches	
	Min.	Max.	Min.	Max.
A	1.90	2.20	0.075	0.086
B	3.50	3.70	0.094	0.110
C	4.20	4.40	0.165	0.173
D	1.10	1.40	0.043	0.055
E	0.15	0.25	0.006	0.010
F	0.95	1.05	0.038	0.041
G	5.10	5.50	0.200	0.216

SMBF Suggested Pad Layout

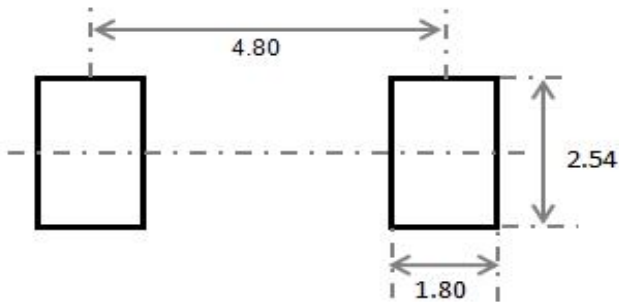

Note:

1. Controlling dimension: in millimeters
2. General tolerance: $\pm 0.05\text{mm}$
3. The pad layout is for reference purposes only

SUPER FAST RECOVERY RECTIFIER DIODE

SMBF Tape and Reel

SMBF Embossed Carrier Tape

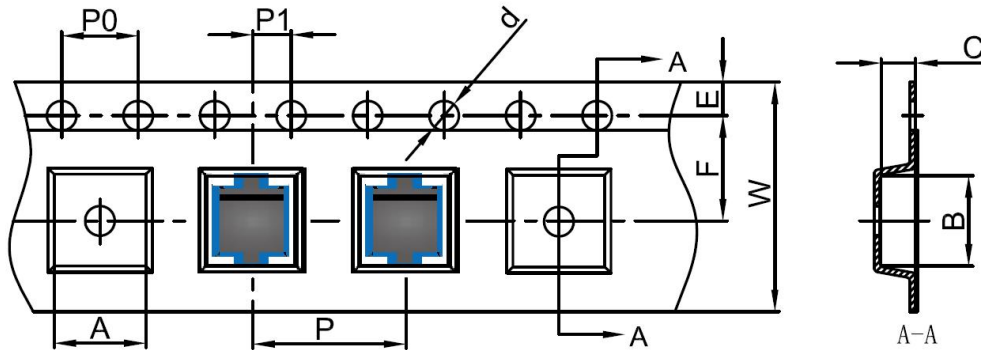

DIMENSIONS ARE IN MILLIMETER										
TYPE	A	B	C	d	E	F	P0	P	P1	W
SMBF	3.80	5.65	1.48	Ø1.50	1.75	5.50	4.00	8.00	2.00	12.00
TOLERANCE	±0.1	±0.1	±0.1	±0.1	±0.1	±0.1	±0.1	±0.1	±0.1	±0.1

SMBF Tape Leader and Trailer

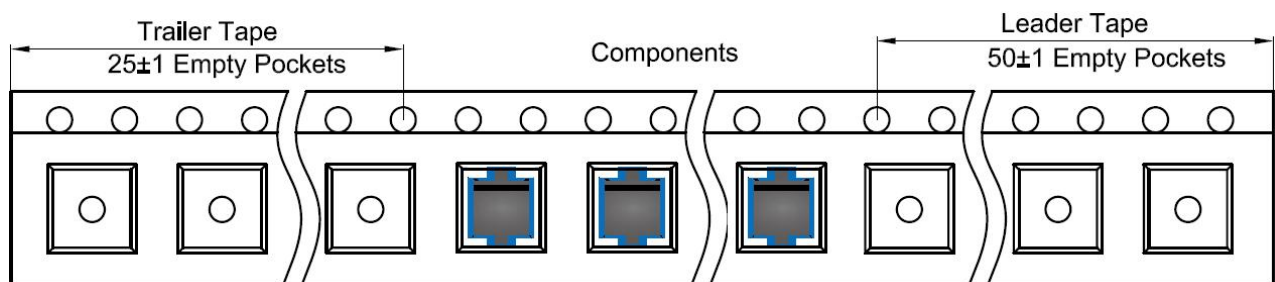

SMBF Reel

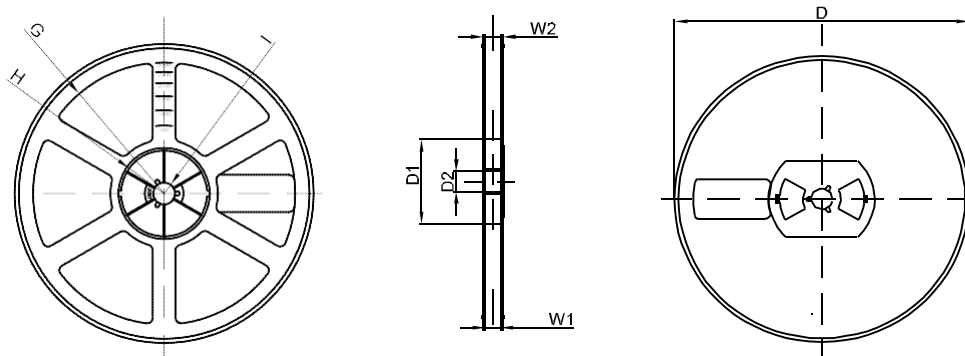

DIMENSIONS ARE IN MILLIMETER								
REEL OPTION	D	D1	D2	G	H	I	W1	W2
13" DIA	Ø330	75.0	13.00	R165	R37.50	R6.50	12.40	17.60
TOLERANCE	±2	±1	±1	±1	±1	±1	±1	±1