

**FEATURES**

- Glass Passivated Die Construction
- Super-Fast Recovery Time For High Efficiency
- Low Forward Voltage Drop and High Current Capability
- Ideally Suited for Automated Assembly
- Plastic Material: UL Flammability Classification Rating 94V-0



SMAF

**MECHANICAL DATA**

- Case: SMAF Molded plastic
- Terminals: Pure tin plated, lead free
- Polarity: Indicated by cathode band
- Weight: 27mg (approx.)



Cathode

**MAXIMUM RATINGS AND ELECTRICAL CHARACTERISTICS**

Ratings at 25 °C ambient temperature unless otherwise specified. Single phase, half wave, 60 Hz, resistive or inductive load. For capacitive load, derate current by 20%.

Parameter	Symbol	ES3AF	ES3BF	ES3CF	ES3DF	ES3EF	ES3GF	ES3JF	Unit	
Maximum Repetitive Peak Reverse Voltage	$V_{RRM}$	50	100	150	200	300	400	600	V	
Maximum RMS Voltage	$V_{RMS}$	35	70	105	140	210	280	420	V	
Maximum DC Blocking Voltage	$V_{DC}$	50	100	150	200	300	400	600	V	
Maximum Average Forward Rectified Current at $T_A = 75\text{ }^\circ\text{C}$	$I_{F(AV)}$	3.0							A	
Peak Forward Surge Current 8.3ms Single Half Sine-wave Superimposed on Rated Load (JEDEC)	$I_{FSM}$	80.0							A	
Maximum Instantaneous Forward Voltage at 3 A	$V_F$	1				1.25		1.68	V	
Maximum DC Reverse Current at Rated DC Blocking Voltage	$I_R$	$T_A = 25\text{ }^\circ\text{C}$							5.0	$\mu\text{A}$
		$T_A = 100\text{ }^\circ\text{C}$							100.0	
Maximum reverse recovery time (NOTE1)	$t_{rr}$	35.0							nS	
Typical Junction Capacitance (NOTE2)	$C_J$	40.0							pF	
Maximum Thermal Resistance (NOTE3)	$R_{\theta JI}$ $R_{\theta JC}$	50.0							$^\circ\text{C/W}$	
		16.0								
Operating and Storage Temperature Range	$T_{J,TS}$	- 50 ~+ 150							$^\circ\text{C}$	

Note: 1.Reverse recovery condition  $I_F=0.5A, I_R=1.0A, I_{rr}=0.25A$

2.Measured at 1MHz and applied reverse voltage of 4.0V D.C.

3.P.C.B. mounted with 0.2x0.2"(5.0x5.0mm) copper pad areas

**Typical Characteristics**

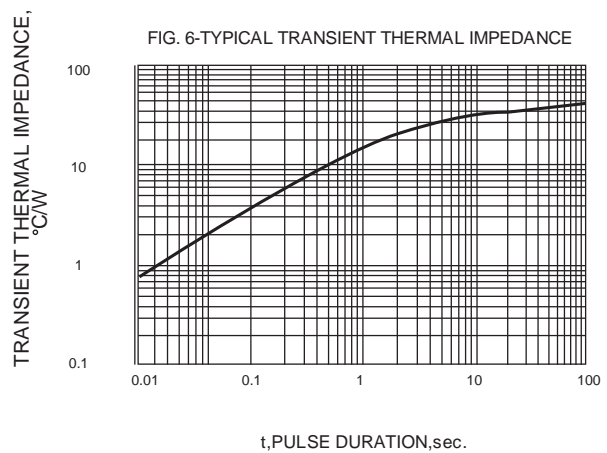
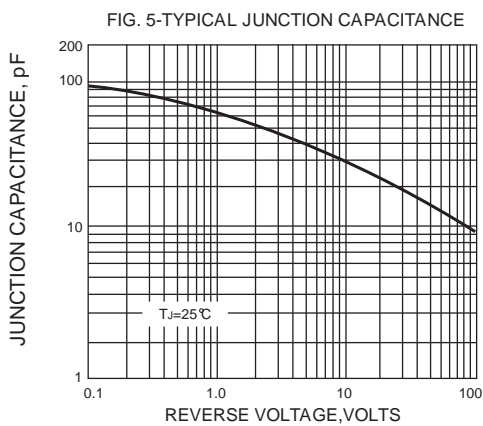
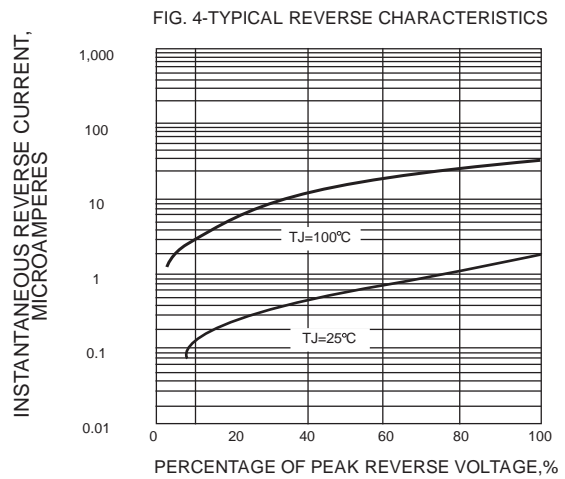
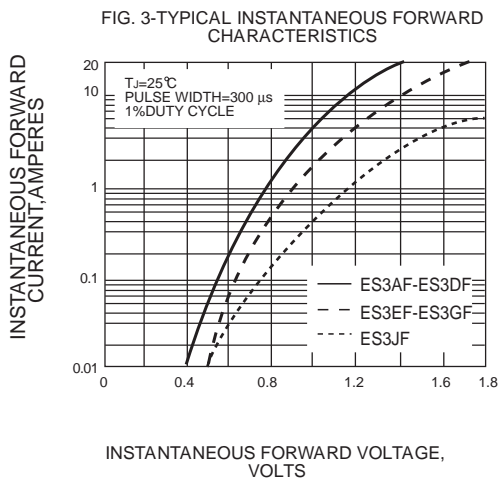
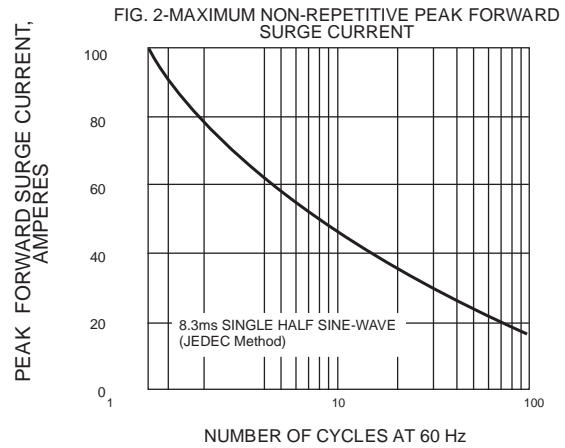
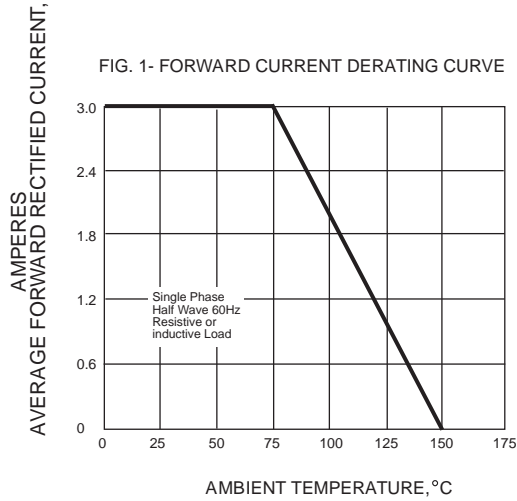

**SMAF Package Outline Dimensions**

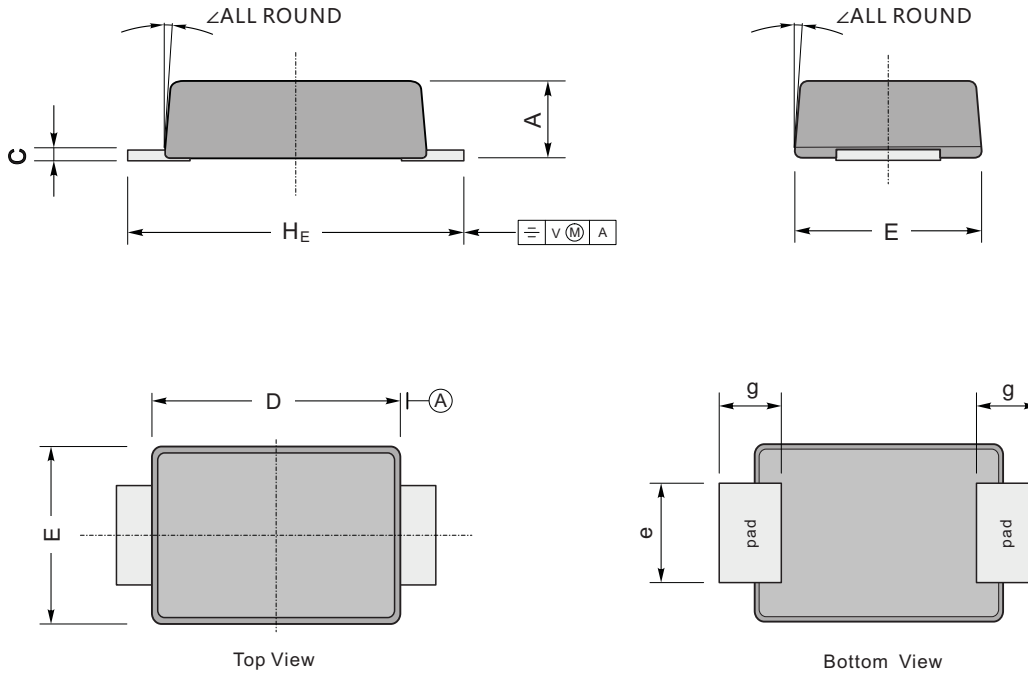

UNIT		A	C	D	E	e	g	H <sub>E</sub>	∠
mm	max	1.1	0.20	3.7	2.7	1.6	1.2	4.9	7°
	min	0.9	0.12	3.3	2.4	1.3	0.8	4.4	
mil	max	43	7.9	146	106	63	47	193	
	min	35	4.7	130	94	51	31	173	