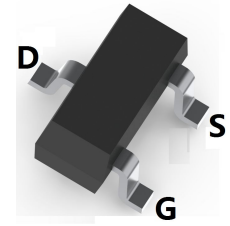
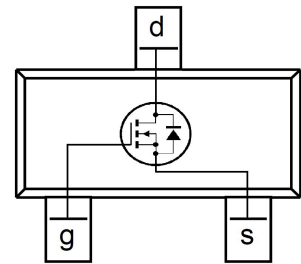


**MOSFET (N-CHANNEL)**
**FEATURES**

- $V_{DS}=30V$ ,  $I_D=5.3A$ ,  $R_{DS(ON)}<27m\Omega@V_{GS}=10V$
- Fast switching
- Ultra Low On-Resistance
- Surface Mount device


**SOT-23**

**MECHANICAL DATA**

- Case: SOT-23
- Case Material: Molded Plastic. UL flammability
- Classification Rating: 94V-0
- Weight: 0.008 grams (approximate)

**MAXIMUM RATINGS ( $T_A = 25^\circ C$  unless otherwise noted)**

Parameter	Symbol	Value	Unit
Drain-source voltage	$V_{DS}$	30	V
Gate-source voltage	$V_{GS}$	$\pm 20$	V
Continuous drain current	$I_D$	$T_A=25^\circ C$	5.3
		$T_A=70^\circ C$	4.3
Pulsed drain current (Note 1)	$I_{DM}$	21	A
Power dissipation	$P_D$	$T_A=25^\circ C$	1.3
		$T_A=70^\circ C$	0.8
Linear Derating Factor		0.01	$W/^\circ C$
Thermal resistance from Junction to ambient	$R_{\theta JA}^*$	100	$^\circ C/W$
Storage and Junction temperature	$T_J, T_{STG}$	-55 ~ +150	$^\circ C$

\*Surface mounted on 1 in square Cu board

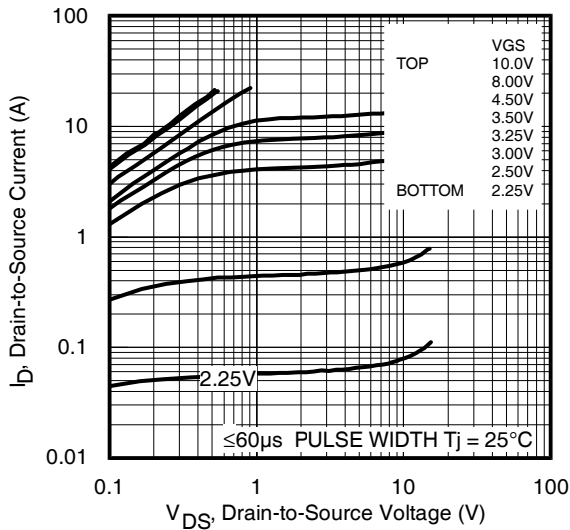
**ELECTRICAL CHARACTERISTICS ( $T_A = 25^\circ C$  unless otherwise specified)**

Parameter	Symbol	Min	Typ	Max	Unit	Conditions
Drain-Source breakdown voltage	$V_{(BR)DSS}$	30			V	$V_{GS}=0V, I_D=250\mu A$
Zero gate voltage drain current	$I_{DSS}$			1	$\mu A$	$V_{DS}=24V, V_{GS}=0V$
				150		$V_{DS}=24V, V_{GS}=0V, T_J=125^\circ C$
Gate-body leakage current	$I_{GSS}$			$\pm 100$	nA	$V_{DS}=0V, V_{GS}=\pm 20V$
Gate-threshold voltage (note 1)	$V_{GS(th)}$	1.3	1.7	2.3	V	$V_{DS}=V_{GS}, I_D=250\mu A$
Drain-source on-resistance(note 1)	$R_{DS(ON)}$		33	40	$m\Omega$	$V_{GS}=4.5V, I_D=4.2A$
			22	27	$m\Omega$	$V_{GS}=10V, I_D=5.2A$
Internal Gate Resistance	$R_G$		2.3		$\Omega$	
Forward transconductance(note 1)	$g_{FS}$	9.5			S	$V_{DS}=10V, I_D=5.2A$
Input capacitance	$C_{iss}$		382		pF	$V_{DS}=15V, V_{GS}=0V, f=1MHz$
Output capacitance	$C_{oss}$		84		pF	
Reverse transfer capacitance	$C_{rss}$		39		pF	
Turn-on delay time	$t_{d(on)}$		5.2		nS	$V_{DD}=15V, I_D=1A, R_G=6.8\Omega, V_{GS}=4.5V$
Turn-on rise time	$t_r$		4.4		nS	
Turn-off delay time	$t_{d(off)}$		7.4		nS	
Turn-off fall time	$t_f$		4.4		nS	
Total gate charge	$Q_g$		2.6		nC	
Gate-source charge	$Q_{gs}$		0.8		nC	$V_{DS}=15V, V_{GS}=4.5V, I_D=5.2A$
Gate-drain charge	$Q_{gd}$		1.1		nC	
Diode forward current(Body Diode)	$I_S$			1.6	A	
Pulsed Source Current(Body Diode)	$I_{SM}$			21	A	
Diode forward voltage (note 1)	$V_{SD}$			1.2	V	$I_S=1.6A, V_{GS}=0V, T_J=25^\circ C$
Reverse Recovery Time	$t_{rr}$		11	17	nS	$T_J=25^\circ C, V_R=15V, I_F=1.6A,$
Reverse Recovery Charge	$Q_{rr}$		4.0	6.0	nC	$di/dt=100A/\mu s$

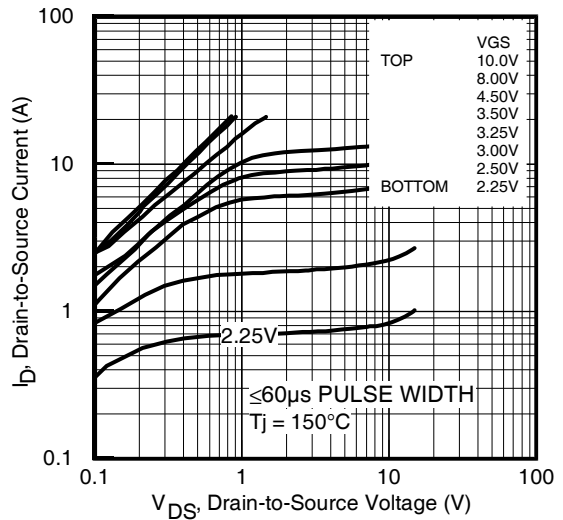
Note:1. Pulse test ; Pulse width  $\leq 400\mu s$ , Duty cycle  $\leq 2\%$  .

**MOSFET (N-CHANNEL)**

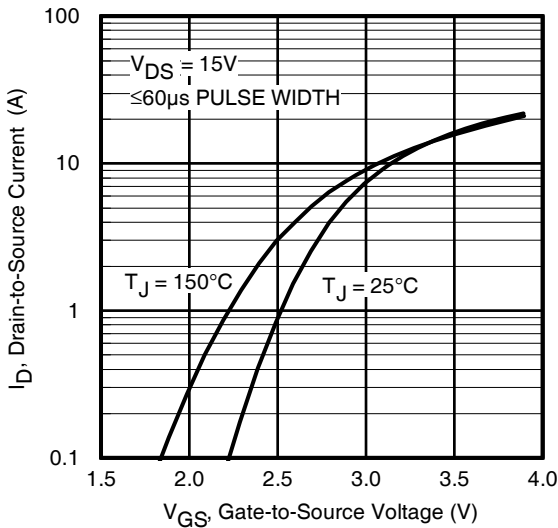
**Typical Characteristics**



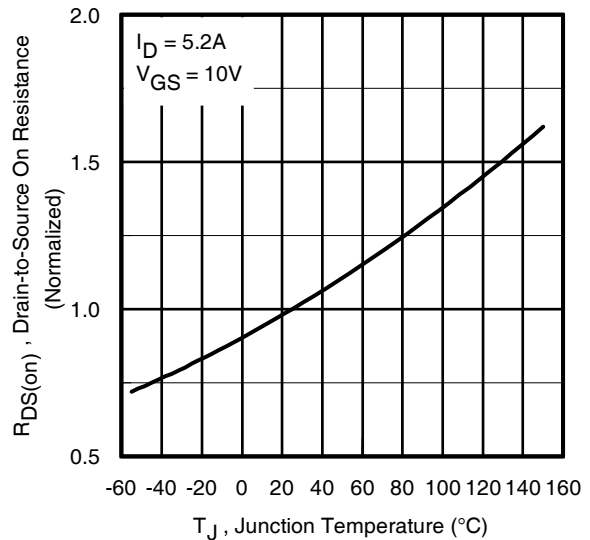
**Fig 1.** Typical Output Characteristics



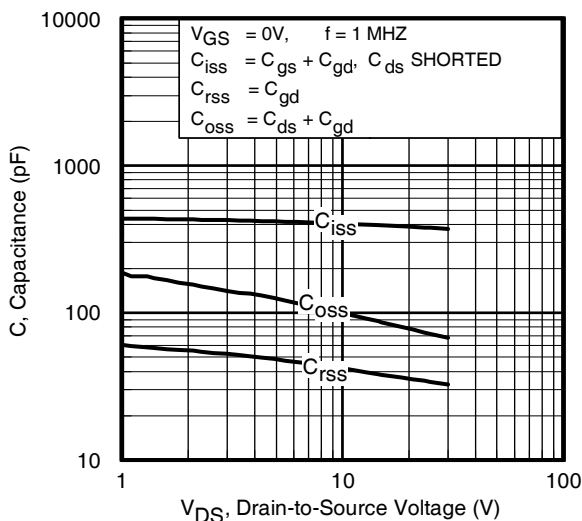
**Fig 2.** Typical Output Characteristics



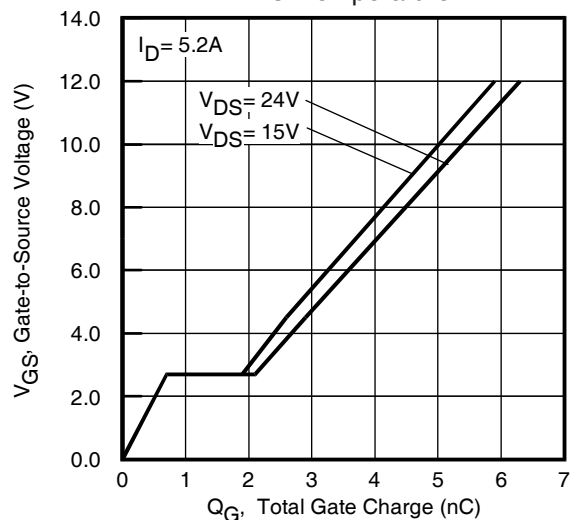
**Fig 3.** Typical Transfer Characteristics



**Fig 4.** Normalized On-Resistance Vs. Temperature

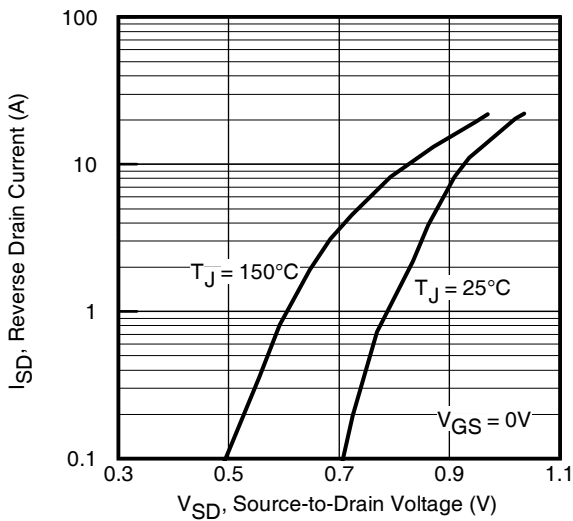


**Fig 5.** Typical Capacitance Vs. Drain-to-Source Voltage

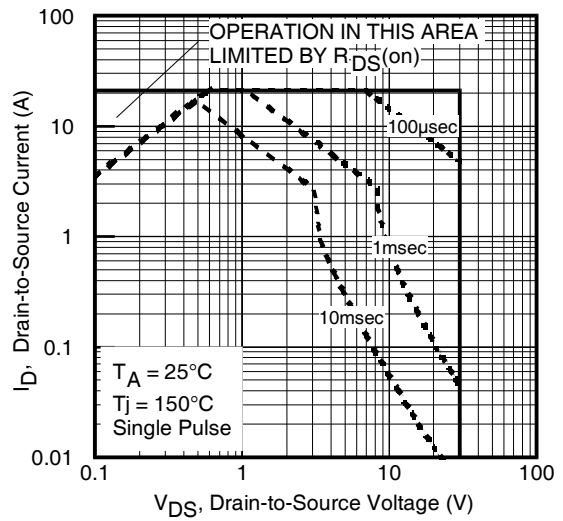


**Fig 6.** Typical Gate Charge Vs. Gate-to-Source Voltage

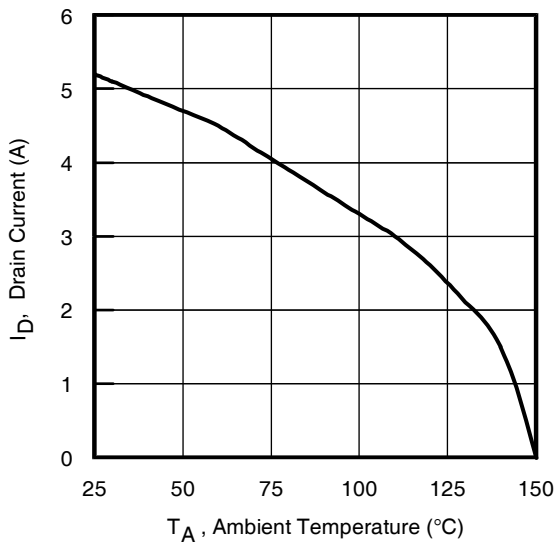
**MOSFET (N-CHANNEL)**



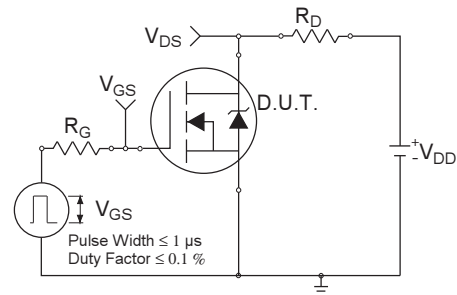
**Fig 7. Typical Source-Drain Diode Forward Voltage**



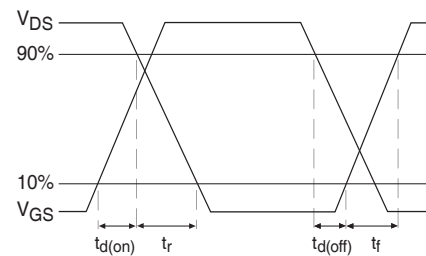
**Fig 8. Maximum Safe Operating Area**



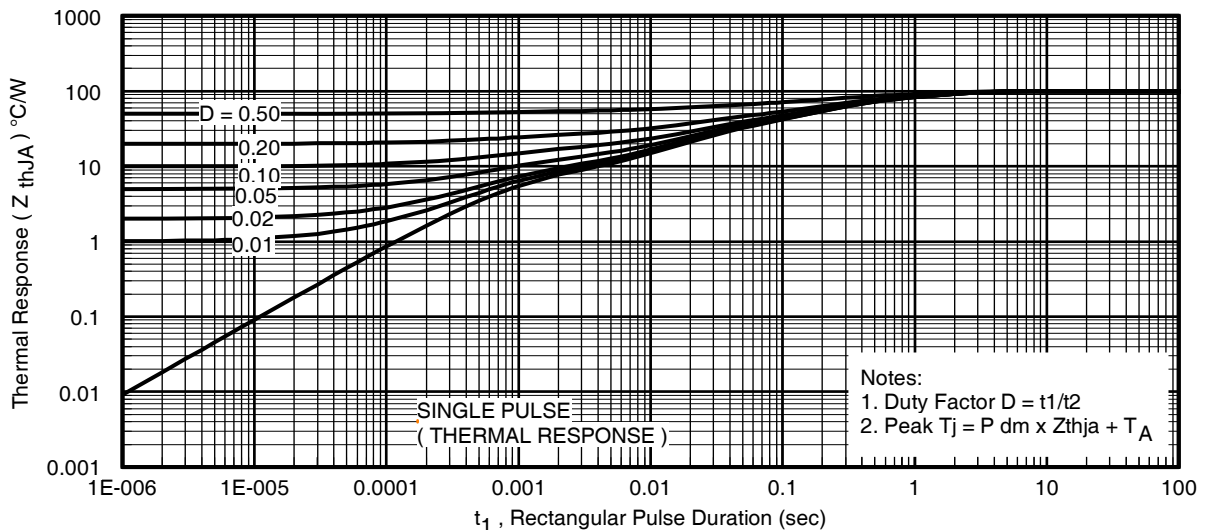
**Fig 9. Maximum Drain Current Vs. Ambient Temperature**



**Fig 10a. Switching Time Test Circuit**

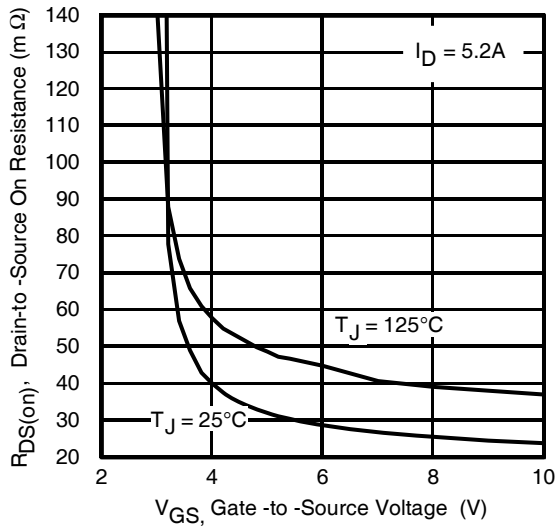


**Fig 10b. Switching Time Waveforms**

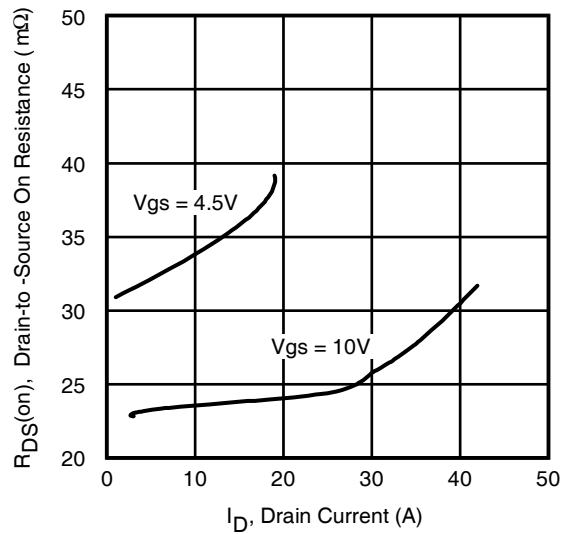


**Fig 11. Typical Effective Transient Thermal Impedance, Junction-to-Ambient**

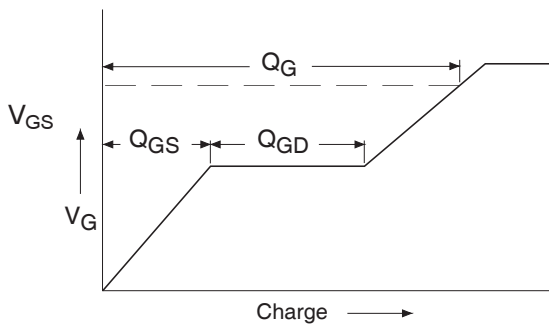
**MOSFET (N-CHANNEL)**



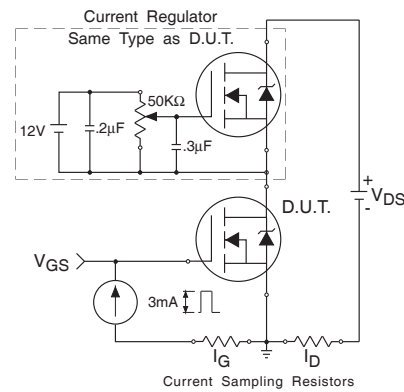
**Fig 12.** Typical On-Resistance Vs. Gate Voltage



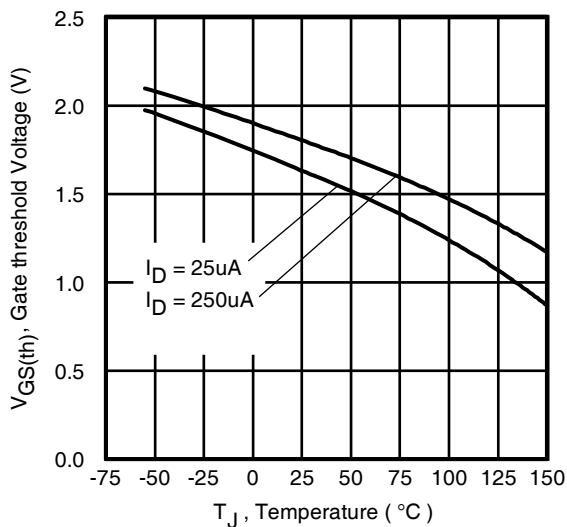
**Fig 13.** Typical On-Resistance Vs. Drain Current



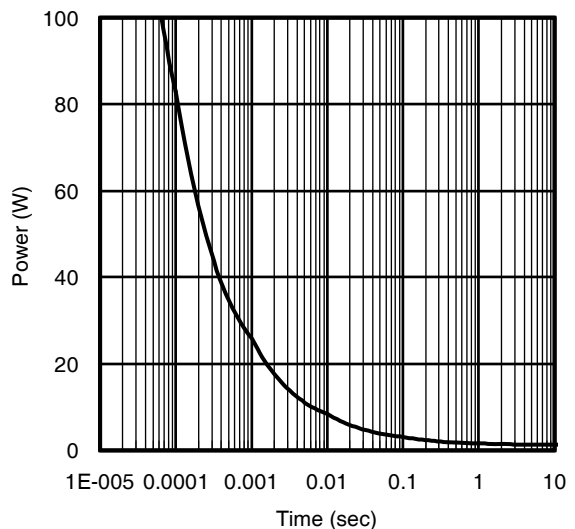
**Fig 14a.** Basic Gate Charge Waveform



**Fig 14b.** Gate Charge Test Circuit



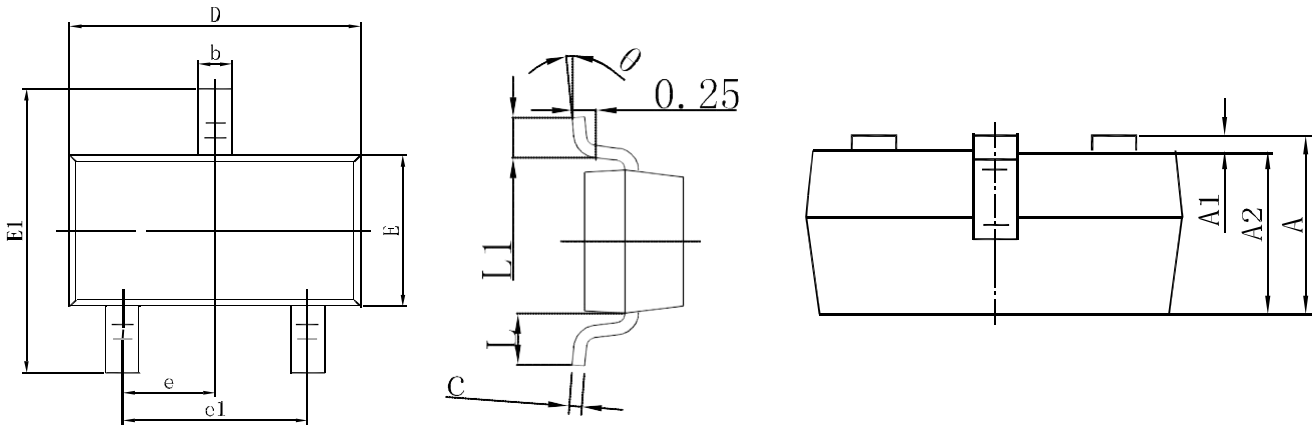
**Fig 15.** Typical Threshold Voltage Vs. Junction Temperature



**Fig 16.** Typical Power Vs. Time

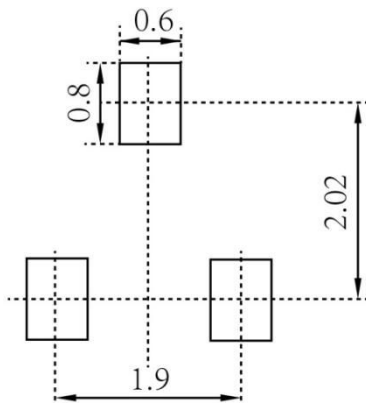
MOSFET (N-CHANNEL)

**SOT-23 Package Outline Dimensions**



Symbol	Dimensions In Millimeters		Dimensions In Inches	
	Min.	Max.	Min.	Max.
A	0.900	1.150	0.035	0.045
A1	0.000	0.100	0.000	0.004
A2	0.900	1.050	0.035	0.041
b	0.300	0.500	0.012	0.020
c	0.080	0.150	0.003	0.006
D	2.800	3.000	0.110	0.118
E	1.200	1.400	0.047	0.055
E1	2.250	2.550	0.089	0.100
e	0.950 TYP		0.037 TYP	
e1	1.800	2.000	0.071	0.079
L	0.550 REF		0.022 REF	
L1	0.300	0.500	0.012	0.020
θ	0°	8°	0°	8°

**SOT-23 Suggested Pad Layout**



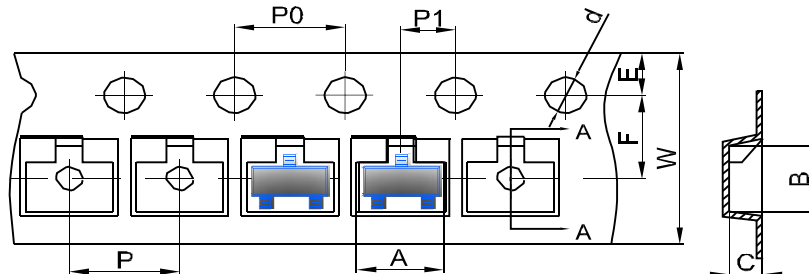
**Note:**

1. Controlling dimension: in millimeters
2. General tolerance:  $\pm 0.05\text{mm}$
3. The pad layout is for reference purposes only

MOSFET (N-CHANNEL)

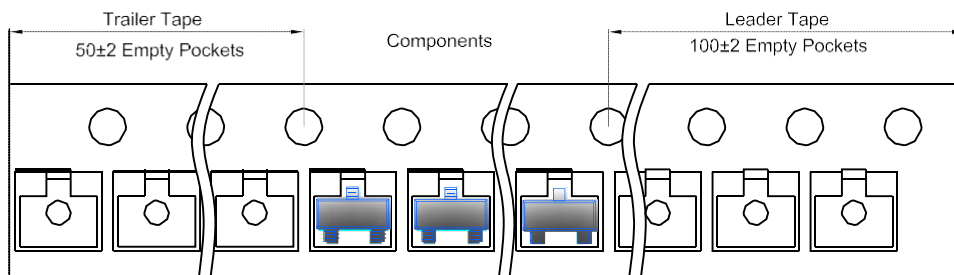
**SOT-23 Tape and Reel**

**SOT-23 Embossed Carrier Tape**

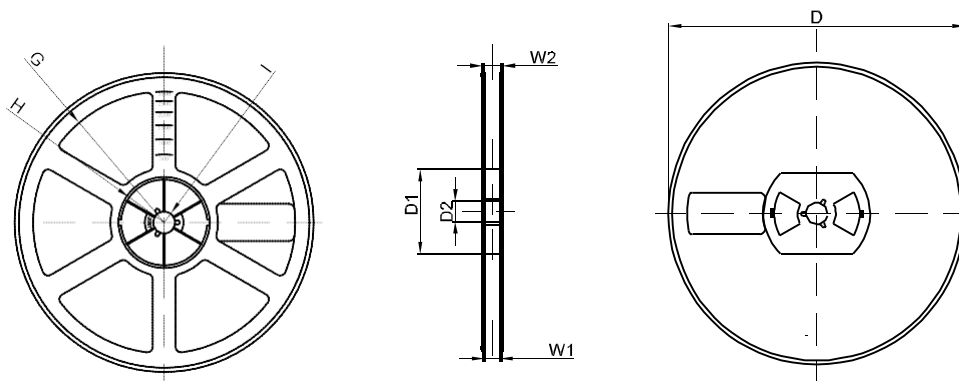


DIMENSIONS ARE IN MILLIMETER										
TYPE	A	B	C	d	E	F	P0	P	P1	W
SOT-23	3.15	2.77	1.22	Ø1.50	1.75	3.50	4.00	4.00	2.00	8.00
TOLERANCE	±0.1	±0.1	±0.1	±0.1	±0.1	±0.1	±0.1	±0.1	±0.1	±0.1

**SOT-23 Tape Leader and Trailer**



**SOT-23 Reel**



DIMENSIONS ARE IN MILLIMETER								
REEL OPTION	D	D1	D2	G	H	I	W1	W2
7" DIA	Ø178	54.40	13.00	R78	R25.60	R6.50	9.50	12.30
TOLERANCE	±2	±1	±1	±1	±1	±1	±1	±1