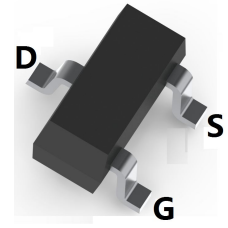


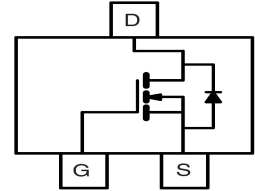
## LOW VOLTAGE MOSFET (N-CHANNEL)

### FEATURES

- Ultra low on-resistance:  $V_{DS}=40V, R_{DS(ON)}=56m\Omega @ V_{GS}=10V, I_D=3.6A$
- For Low power DC to DC converter application
- For Load switch application
- Surface Mount device



SOT-23



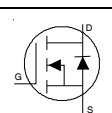
### MECHANICAL DATA

- Case: SOT-23
- Case Material: Molded Plastic. UL flammability
- Classification Rating: 94V-0
- Weight: 0.008 grams (approximate)

### MAXIMUM RATINGS ( $T_A = 25^\circ\text{C}$ unless otherwise noted)

Symbol	Parameter	Max.	Units
$V_{DS}$	Drain-Source Voltage	40	V
$I_D @ T_A = 25^\circ\text{C}$	Continuous Drain Current, $V_{GS} @ 10V$	3.6	A
$I_D @ T_A = 70^\circ\text{C}$	Continuous Drain Current, $V_{GS} @ 10V$	2.9	
$I_{DM}$	Pulsed Drain Current	15	
$P_D @ T_A = 25^\circ\text{C}$	Maximum Power Dissipation	1.3	W
$P_D @ T_A = 70^\circ\text{C}$	Maximum Power Dissipation	0.8	
	Linear Derating Factor	0.01	W/ $^\circ\text{C}$
$V_{GS}$	Gate-to-Source Voltage	$\pm 16$	V
$T_J, T_{STG}$	Junction and Storage Temperature Range	-55 to +150	$^\circ\text{C}$
$R_{\theta JA}$	Junction-to-Ambient <sup>③</sup>	100	$^\circ\text{C/W}$
$R_{\theta JA}$	Junction-to-Ambient ( $t < 10s$ )	99	

### Electric Characteristics @ $T_J = 25^\circ\text{C}$ (unless otherwise specified)

Symbol	Parameter	Min.	Typ.	Max.	Units	Conditions
$V_{(BR)DSS}$	Drain-to-Source Breakdown Voltage	40	—	—	V	$V_{GS} = 0V, I_D = 250\mu A$
$\Delta V_{(BR)DSS}/\Delta T_J$	Breakdown Voltage Temp. Coefficient	—	0.04	—	V/ $^\circ\text{C}$	Reference to $25^\circ\text{C}, I_D = 1mA$
$R_{DS(on)}$	Static Drain-to-Source On-Resistance	—	44	56	m $\Omega$	$V_{GS} = 10V, I_D = 3.6A$ <sup>②</sup>
		—	62	78		$V_{GS} = 4.5V, I_D = 2.9A$ <sup>②</sup>
$V_{GS(th)}$	Gate Threshold Voltage	1.0	1.8	2.5	V	$V_{DS} = V_{GS}, I_D = 25\mu A$
$I_{DSS}$	Drain-to-Source Leakage Current	—	—	20	$\mu A$	$V_{DS} = 40V, V_{GS} = 0V$
		—	—	250		$V_{DS} = 40V, V_{GS} = 0V, T_J = 125^\circ\text{C}$
$I_{GSS}$	Gate-to-Source Forward Leakage	—	—	100	nA	$V_{GS} = 16V$
	Gate-to-Source Reverse Leakage	—	—	-100		$V_{GS} = -16V$
$R_G$	Internal Gate Resistance	—	1.1	—	$\Omega$	
$g_{fs}$	Forward Transconductance	6.2	—	—	S	$V_{DS} = 10V, I_D = 3.6A$
$Q_g$	Total Gate Charge	—	2.6	3.9	nC	$I_D = 3.6A$
$Q_{gs}$	Gate-to-Source Charge	—	0.7	—		$V_{DS} = 20V$
$Q_{gd}$	Gate-to-Drain ("Miller") Charge	—	1.4	—		$V_{GS} = 4.5V$ <sup>②</sup>
$t_{d(on)}$	Turn-On Delay Time	—	5.1	—	ns	$V_{DD} = 20V$
$t_r$	Rise Time	—	5.4	—		$I_D = 1.0A$
$t_{d(off)}$	Turn-Off Delay Time	—	6.4	—		$R_G = 6.8\Omega$
$t_f$	Fall Time	—	4.3	—		$V_{GS} = 4.5V$
$C_{iss}$	Input Capacitance	—	266	—	pF	$V_{GS} = 0V$
$C_{oss}$	Output Capacitance	—	49	—		$V_{DS} = 25V$
$C_{rss}$	Reverse Transfer Capacitance	—	29	—		$f = 1.0MHz$
$I_S$	Continuous Source Current (Body Diode)	—	—	1.3	A	MOSFET symbol showing the integral reverse p-n junction diode. 
$I_{SM}$	Pulsed Source Current (Body Diode) <sup>①</sup>	—	—	15		
$V_{SD}$	Diode Forward Voltage	—	—	1.2	V	$T_J = 25^\circ\text{C}, I_S = 1.3A, V_{GS} = 0V$ <sup>②</sup>
$t_{rr}$	Reverse Recovery Time	—	10	—	ns	$T_J = 25^\circ\text{C}, V_R = 32V, I_F = 1.3A$
$Q_{rr}$	Reverse Recovery Charge	—	9.3	—	nC	$di/dt = 100A/\mu s$ <sup>②</sup>

Notes: <sup>①</sup> Repetitive rating; pulse width limited by max. junction temperature.

<sup>②</sup> Pulse width  $\leq 400\mu s$ ; duty cycle  $\leq 2\%$ .

<sup>③</sup> Surface mounted on 1 in square Cu board

LOW VOLTAGE MOSFET (N-CANNEL)

Typical Characteristics

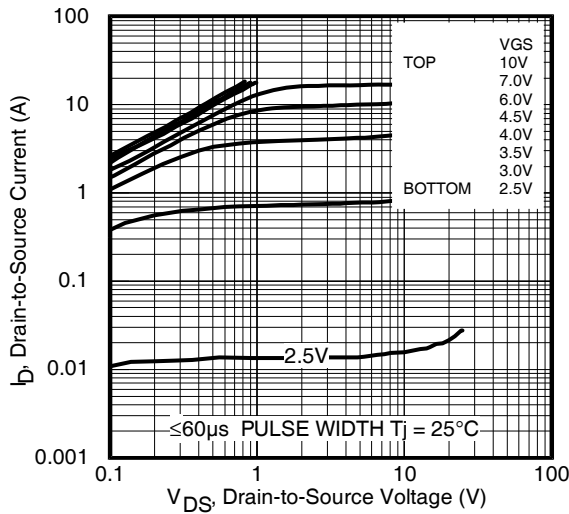


Fig 1. Typical Output Characteristics

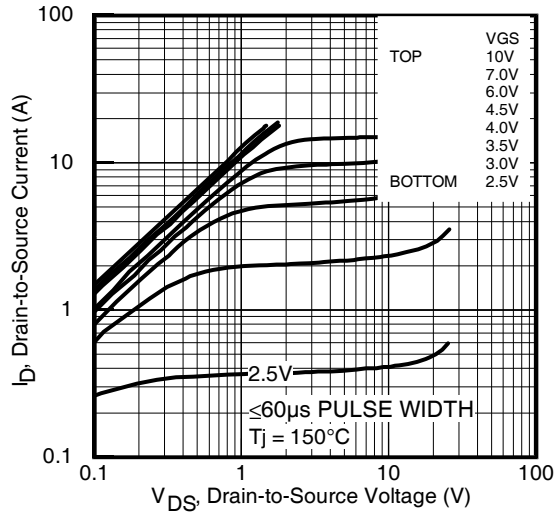


Fig 2. Typical Output Characteristics

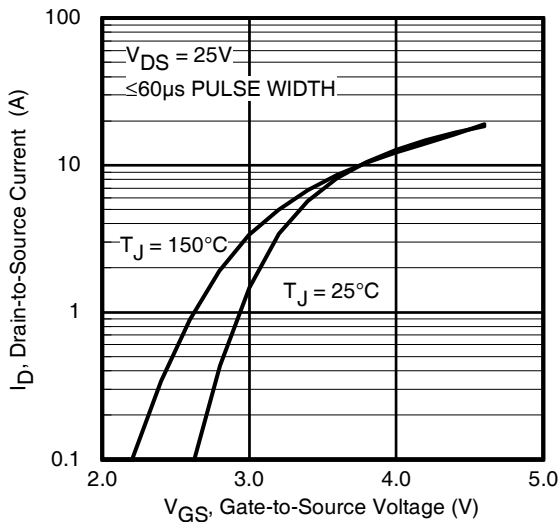


Fig 3. Typical Transfer Characteristics

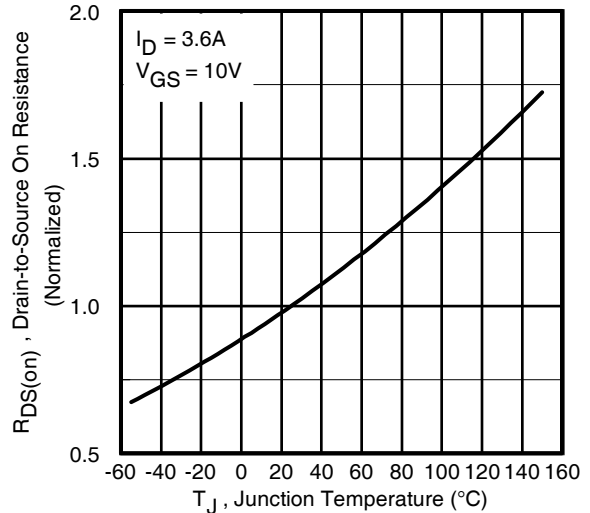


Fig 4. Normalized On-Resistance Vs. Temperature

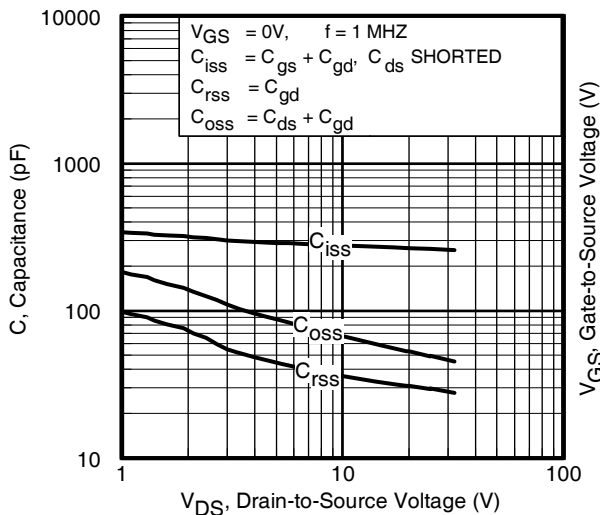


Fig 5. Typical Capacitance Vs. Drain-to-Source Voltage

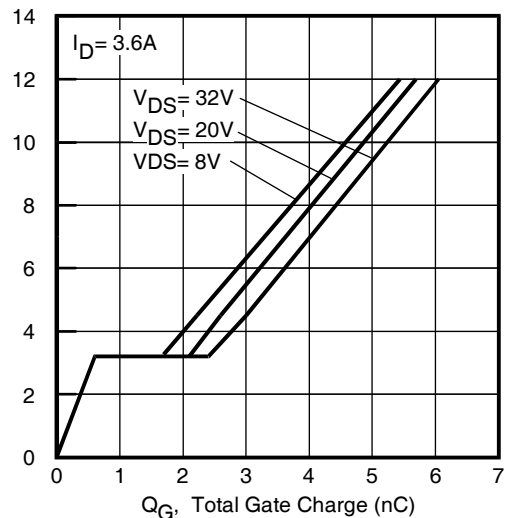
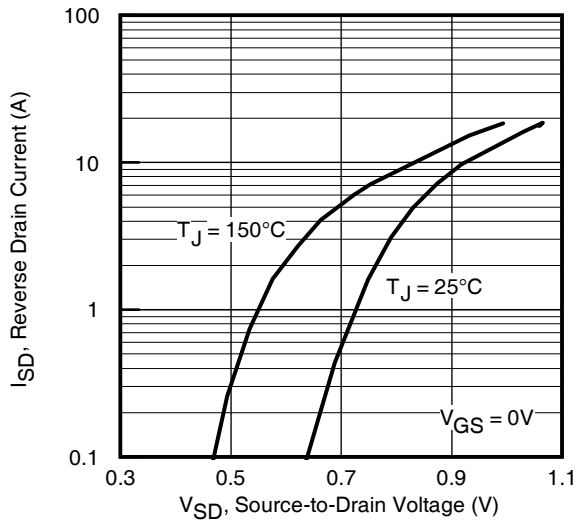
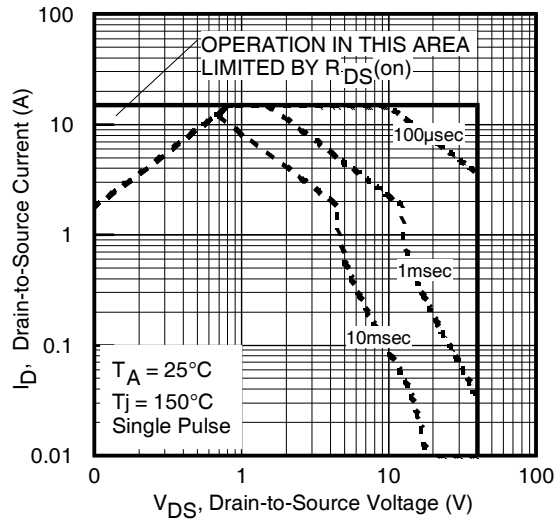


Fig 6. Typical Gate Charge Vs. Gate-to-Source Voltage

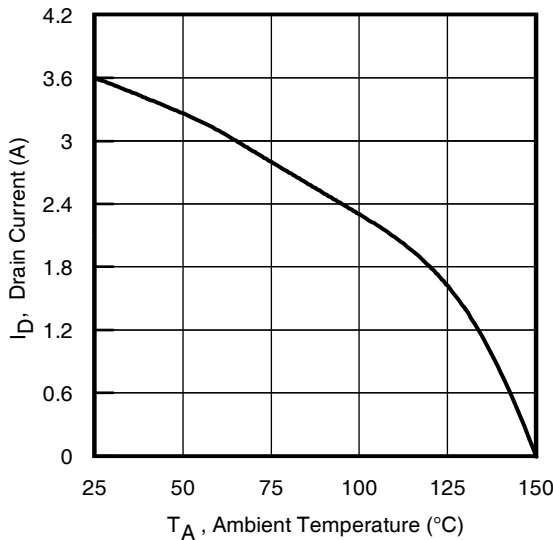
LOW VOLTAGE MOSFET (N-CANNEL)



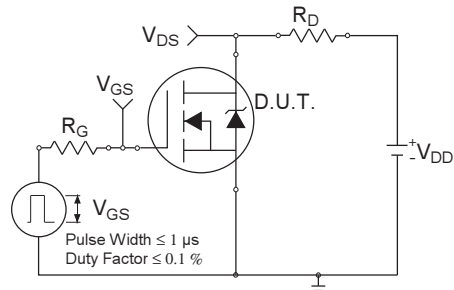
**Fig 7.** Typical Source-Drain Diode Forward Voltage



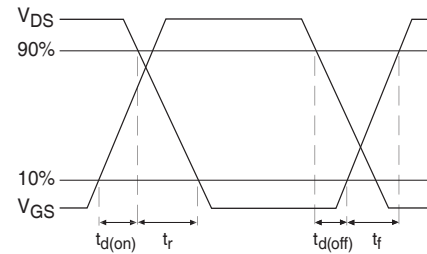
**Fig 8.** Maximum Safe Operating Area



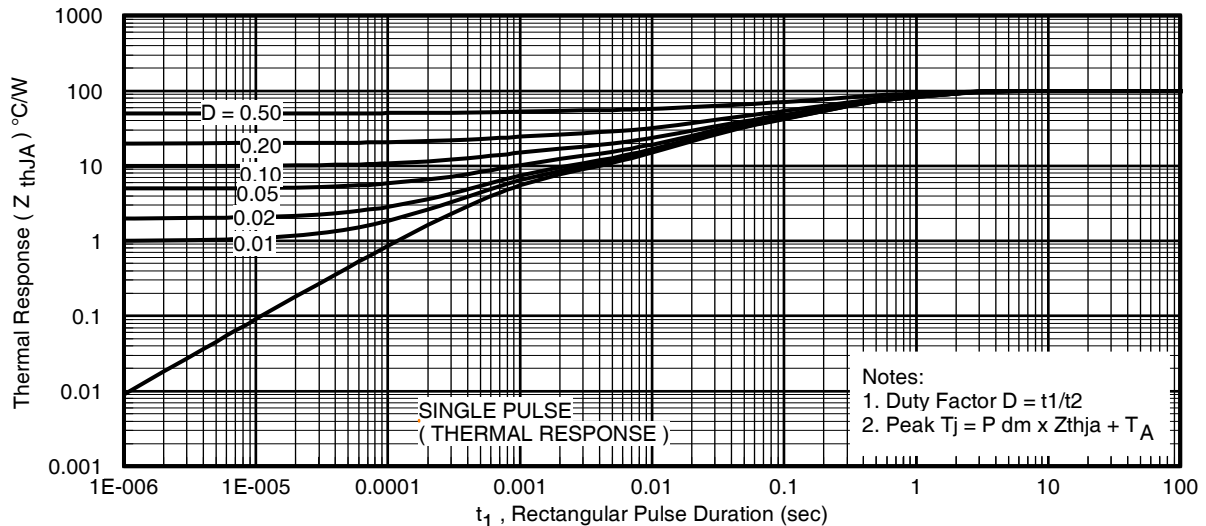
**Fig 9.** Maximum Drain Current Vs. Ambient Temperature



**Fig 10a.** Switching Time Test Circuit

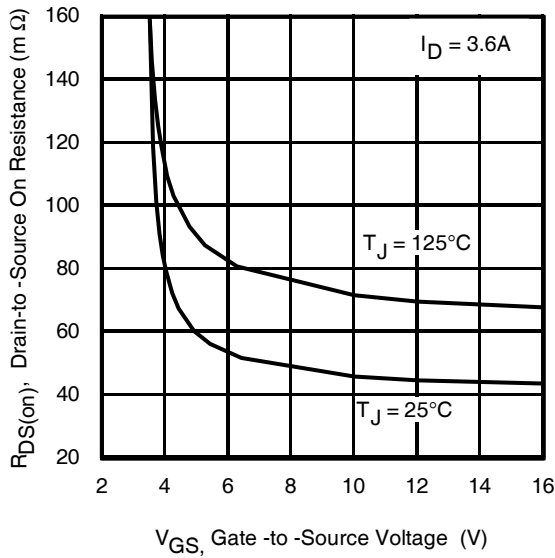


**Fig 10b.** Switching Time Waveforms

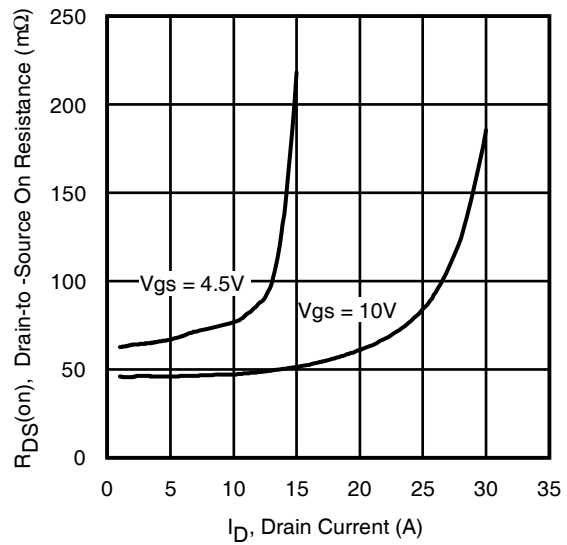


**Fig 11.** Typical Effective Transient Thermal Impedance, Junction-to-Ambient

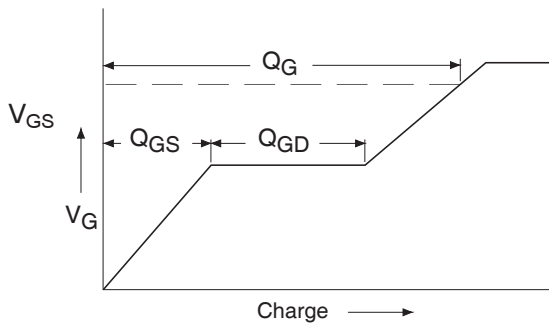
LOW VOLTAGE MOSFET (N-CHANNEL)



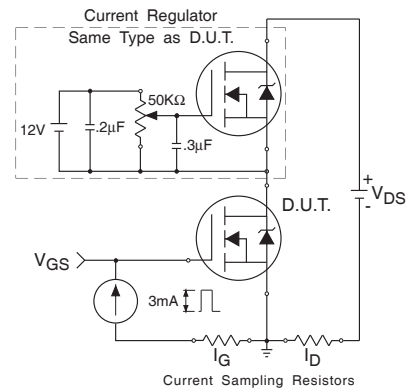
**Fig 12.** Typical On-Resistance Vs. Gate Voltage



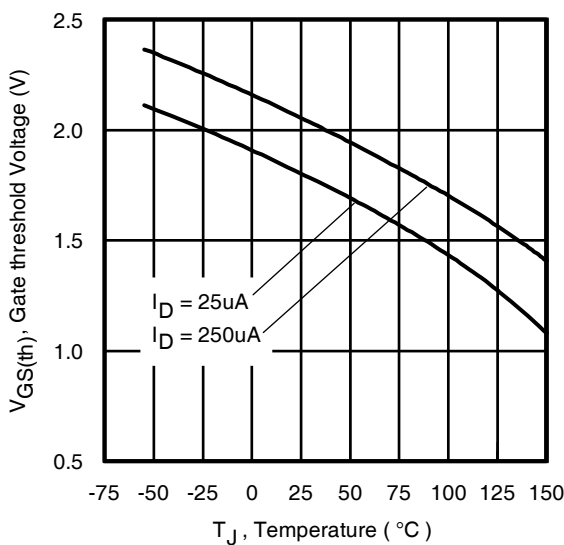
**Fig 13.** Typical On-Resistance Vs. Drain Current



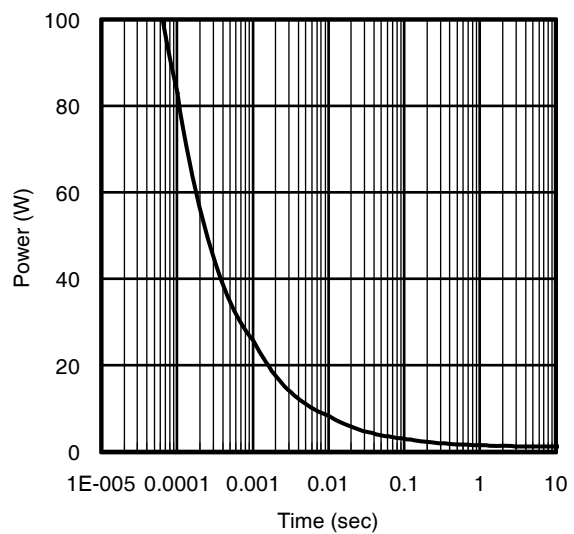
**Fig 14a.** Basic Gate Charge Waveform



**Fig 14b.** Gate Charge Test Circuit



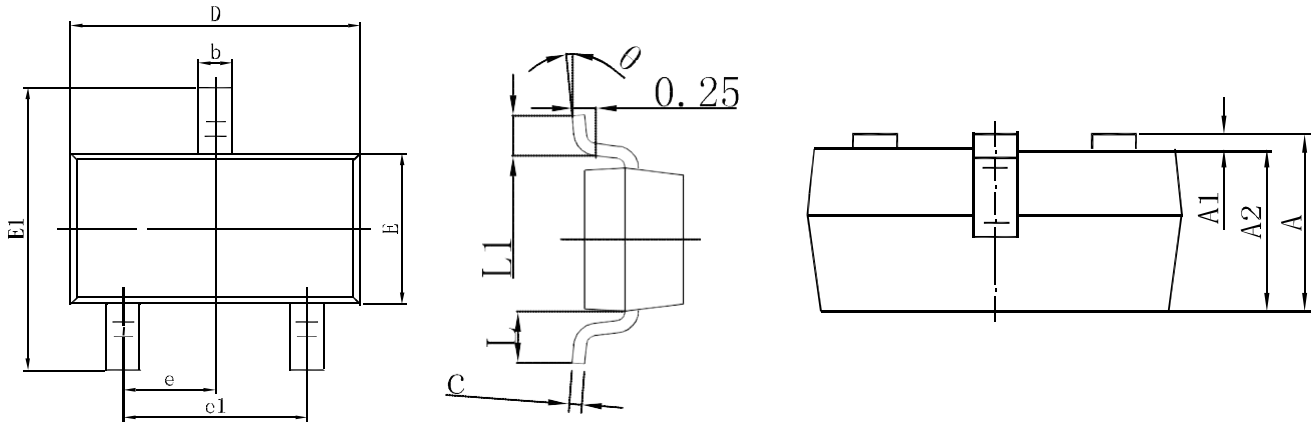
**Fig 15.** Typical Threshold Voltage Vs. Junction Temperature



**Fig 16.** Typical Power Vs. Time

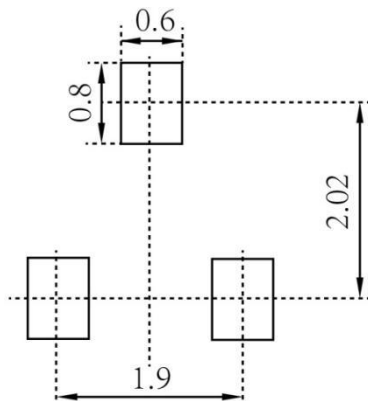
LOW VOLTAGE MOSFET (N-CHANNEL)

SOT-23 Package Outline Dimensions



Symbol	Dimensions In Millimeters		Dimensions In Inches	
	Min.	Max.	Min.	Max.
A	0.900	1.150	0.035	0.045
A1	0.000	0.100	0.000	0.004
A2	0.900	1.050	0.035	0.041
b	0.300	0.500	0.012	0.020
c	0.080	0.150	0.003	0.006
D	2.800	3.000	0.110	0.118
E	1.200	1.400	0.047	0.055
E1	2.250	2.550	0.089	0.100
e	0.950 TYP		0.037 TYP	
e1	1.800	2.000	0.071	0.079
L	0.550 REF		0.022 REF	
L1	0.300	0.500	0.012	0.020
θ	0°	8°	0°	8°

SOT-23 Suggested Pad Layout



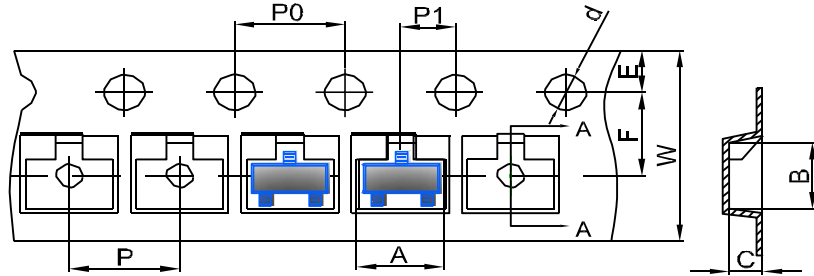
**Note:**

1. Controlling dimension: in millimeters
2. General tolerance:  $\pm 0.05\text{mm}$
3. The pad layout is for reference purposes only

LOW VOLTAGE MOSFET (N-CHANNEL)

**SOT-23 Tape and Reel**

**SOT-23 Embossed Carrier Tape**

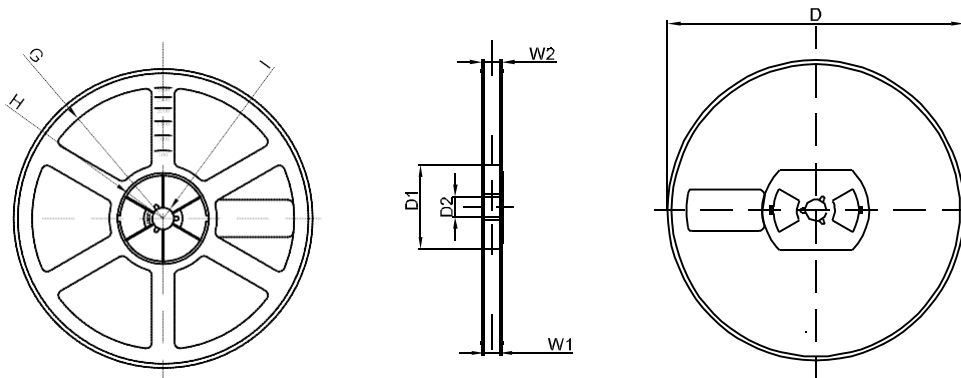


DIMENSIONS ARE IN MILLIMETER										
TYPE	A	B	C	d	E	F	P0	P	P1	W
SOT-23	3.15	2.77	1.22	Ø1.50	1.75	3.50	4.00	4.00	2.00	8.00
TOLERANCE	±0.1	±0.1	±0.1	±0.1	±0.1	±0.1	±0.1	±0.1	±0.1	±0.1

**SOT-23 Tape Leader and Trailer**



**SOT-23 Reel**



DIMENSIONS ARE IN MILLIMETER								
REEL OPTION	D	D1	D2	G	H	I	W1	W2
7" DIA	Ø178	54.40	13.00	R78	R25.60	R6.50	9.50	12.30
TOLERANCE	±2	±1	±1	±1	±1	±1	±1	±1