

ZENER DIODE

FEATURES

- Total power dissipation: max. 500 mW
- Small plastic package suitable for surface mounted design
- Wide variety of voltage ranges: nom.2.0 to 120V (E24 range)
- Tolerance approximately + / - 5%

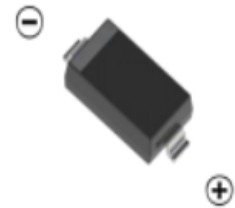

SOD-123

MECHANICAL DATA

- Case: SOD-123
- Case Material: Molded Plastic. UL flammability
- Classification Rating: 94V-0
- Weight: 0.005 grams (approximate)

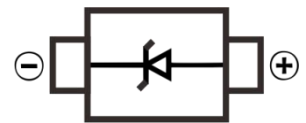

MAXIMUM RATINGS ($T_A = 25^\circ\text{C}$ unless otherwise noted)

	Symbol	Value	Unit
Zener Current see Table "Characteristics"			
Power Dissipation	P_{tot}	500	mW
Junction Temperature	T_j	150	$^\circ\text{C}$
Storage Temperature Range	T_s	-55 to +150	$^\circ\text{C}$

ELECTRICAL CHARACTERISTICS ($T_A = 25^\circ\text{C}$ unless otherwise specified)

	Symbol	Min.	Typ.	Max.	Unit
Thermal Resistance Junction to Ambient Air	R_{thA}	-	-	0.3	K/mW
Forward Voltage at $I_F = 10\text{mA}$	V_F	-	-	0.9	V

ZENER DIODE

ELECTRICAL CHARACTERISTICS (T_A = 25°C unless otherwise specified)

Type	Marking Code	Zener Voltage Range ¹⁾			Dynamic Impedance ²⁾		Reverse Leakage Current		Temp. coefficient of Zener Voltage
		V _{Znom} V	I _{ZT} mA	for V _{ZT} V	Z _Z (Max) Ω	at I _Z mA	I _R (Max) μA	at V _R V	TKvz %/K
MM1Z 2V0	4A	2.0	5	1.80...2.15	100	5	120	0.5	-0.09...-0.06
MM1Z 2V2	4B	2.2	5	2.08...2.33	100	5	120	0.7	-0.09...-0.06
MM1Z 2V4	4C	2.4	5	2.28...2.56	100	5	120	1.0	-0.09...-0.06
MM1Z 2V7	4D	2.7	5	2.5...2.9	110	5	120	1.0	-0.09...-0.06
MM1Z 3V0	4E	3.0	5	2.8...3.2	120	5	50	1.0	-0.08...-0.05
MM1Z 3V3	4F	3.3	5	3.1...3.5	130	5	20	1.0	-0.08...-0.05
MM1Z 3V6	4H	3.6	5	3.4...3.8	130	5	10	1.0	-0.08...-0.05
MM1Z 3V9	4J	3.9	5	3.7...4.1	130	5	5	1.0	-0.08...-0.05
MM1Z 4V3	4K	4.3	5	4.0...4.6	130	5	5	1.0	-0.06...-0.03
MM1Z 4V7	4M	4.7	5	4.4...5.0	130	5	2	1.0	-0.05...+0.02
MM1Z 5V1	4N	5.1	5	4.8...5.4	130	5	2	1.5	-0.02...+0.02
MM1Z 5V6	4P	5.6	5	5.2...6.0	80	5	1	2.5	-0.05...+0.05
MM1Z 6V2	4R	6.2	5	5.8...6.6	50	5	1	3.0	0.03...0.06
MM1Z 6V8	4X	6.8	5	6.4...7.2	30	5	0.5	3.5	0.03...0.07
MM1Z 7V5	4Y	7.5	5	7.0...7.9	30	5	0.5	4.0	0.03...0.07
MM1Z 8V2	4Z	8.2	5	7.7...8.7	30	5	0.5	5.0	0.03...0.08
MM1Z 9V1	5A	9.1	5	8.5...9.6	30	5	0.5	6.0	0.03...0.09
MM1Z 10	5B	10	5	9.4...10.6	30	5	0.1	7.0	0.03...0.1
MM1Z 11	5C	11	5	10.4...11.6	30	5	0.1	8.0	0.03...0.11
MM1Z 12	5D	12	5	11.4...12.7	35	5	0.1	9.0	0.03...0.11
MM1Z 13	5E	13	5	12.4...14.1	35	5	0.1	10	0.03...0.11
MM1Z 15	5F	15	5	13.8...15.6	40	5	0.1	11	0.03...0.11
MM1Z 16	5H	16	5	15.3...17.1	40	5	0.1	12	0.03...0.11
MM1Z 18	5J	18	5	16.8...19.1	45	5	0.1	13	0.03...0.11
MM1Z 20	5K	20	5	18.8...21.2	50	5	0.1	15	0.03...0.11
MM1Z 22	5M	22	5	20.8...23.3	55	5	0.1	17	0.04...0.12
MM1Z 24	5N	24	5	22.8...25.6	60	5	0.1	19	0.04...0.12
MM1Z 27	5P	27	5	25.1...28.9	70	2	0.1	21	0.04...0.12
MM1Z 30	5R	30	5	28...32	80	2	0.1	23	0.04...0.12
MM1Z 33	5X	33	5	31...35	80	2	0.1	25	0.04...0.12
MM1Z 36	5Y	36	5	34...38	90	2	0.1	27	0.04...0.12
MM1Z 39	5Z	39	2.5	37...41	100	2	2	30	0.04...0.12
MM1Z 43	6A	43	2.5	40...46	130	2	2	33	0.04...0.12
MM1Z 47	6B	47	2.5	44...50	150	2	2	36	0.04...0.12
MM1Z 51	6C	51	2.5	48...54	180	2	1	39	0.04...0.12
MM1Z 56	6D	56	2.5	52...60	180	2	1	43	0.04...0.12
MM1Z 62	6E	62	2.5	58...66	200	2	0.2	47	0.04...0.12
MM1Z 68	6F	68	2.5	64...72	250	2	0.2	52	0.04...0.12
MM1Z 75	6H	75	2.5	70...79	300	2	0.2	57	0.04...0.12
MM1Z 82	6J	82	2.5	77...87	300	2	0.2	63	0.05...0.12
MM1Z 91	6K	91	1	85...96	700	1	0.2	69	0.05...0.12
MM1Z 100	6M	100	1	94...106	700	1	0.2	76	0.05...0.12
MM1Z 110	6N	110	1	104...116	800	1	0.2	84	0.05...0.12
MM1Z 120	6P	120	1	114...127	900	1	0.2	91	0.05...0.12

1) V_Z is tested with pulses (20 ms).

2) Z_Z is measured at I_Z by given a very small A.C. current signal.

ZENER DIODE

Typical Characteristics

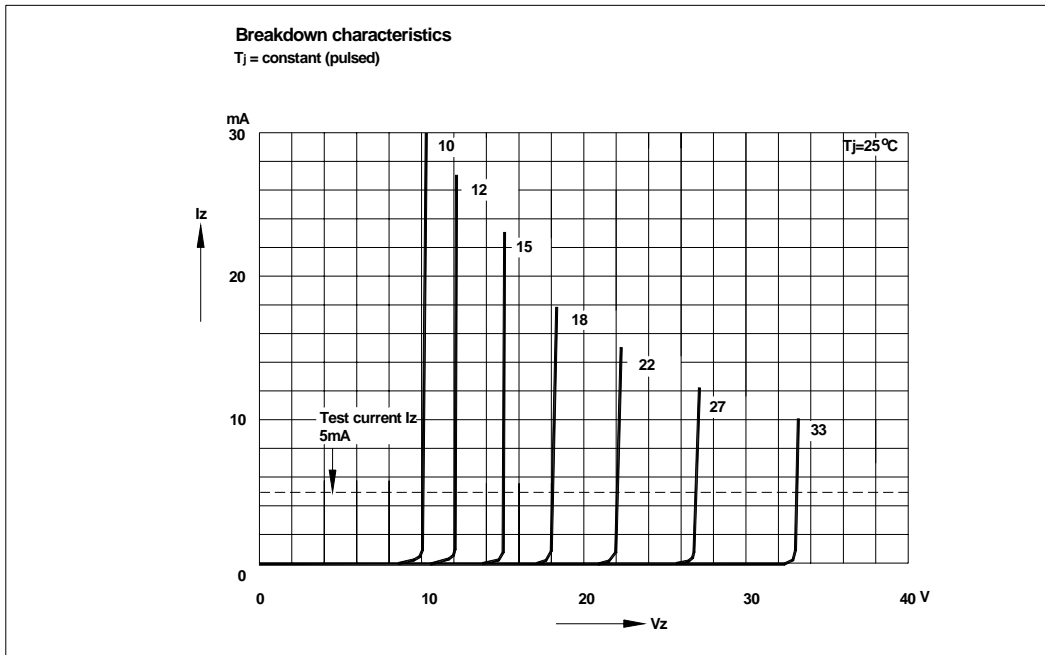
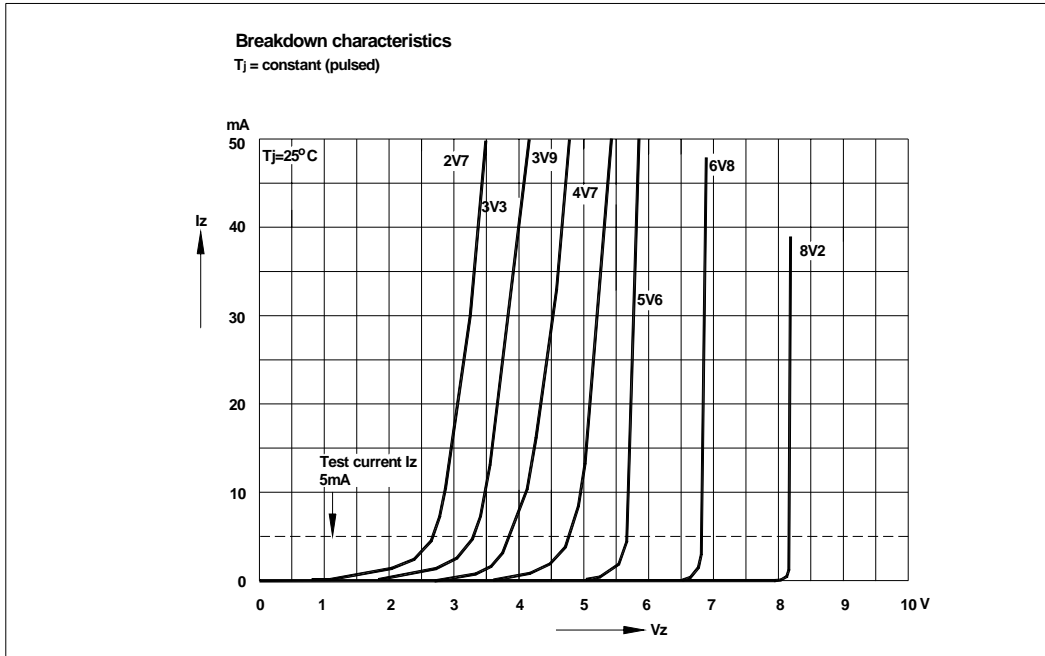

ZENER DIODE

SOD-123 Package Outline Dimensions

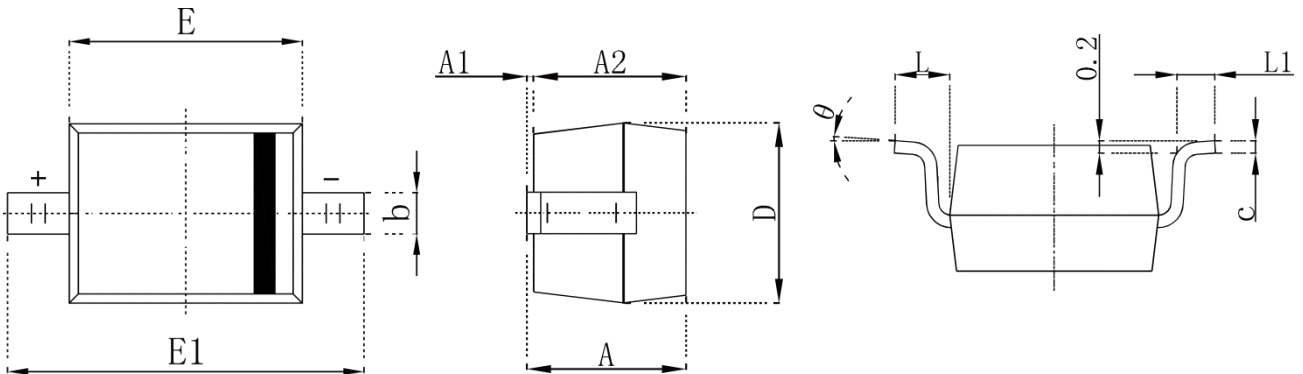

Symbol	Dimensions In Millimeters		Dimensions In Inches	
	Min.	Max.	Min.	Max.
A	1.050	1.250	0.041	0.049
A1	0.000	0.100	0.000	0.004
A2	1.050	1.150	0.041	0.045
b	0.450	0.650	0.018	0.026
c	0.080	0.150	0.003	0.006
D	1.500	1.700	0.059	0.067
E	2.600	2.800	0.102	0.110
E1	3.550	3.850	0.140	0.152
L	0.500REF		0.020 REF	
L1	0.250	0.450	0.010	0.018
θ	0°	8°	0°	8°

SOD-123 Suggested Pad Layout

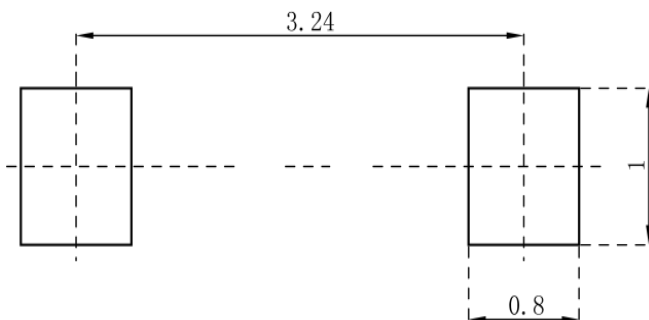

Note:

1. Controlling dimension: in millimeters
2. General tolerance: $\pm 0.05\text{mm}$
3. The pad layout is for reference purposes only

ZENER DIODE

SOD-123 Tape and Reel

SOD-123 Embossed Carrier Tape

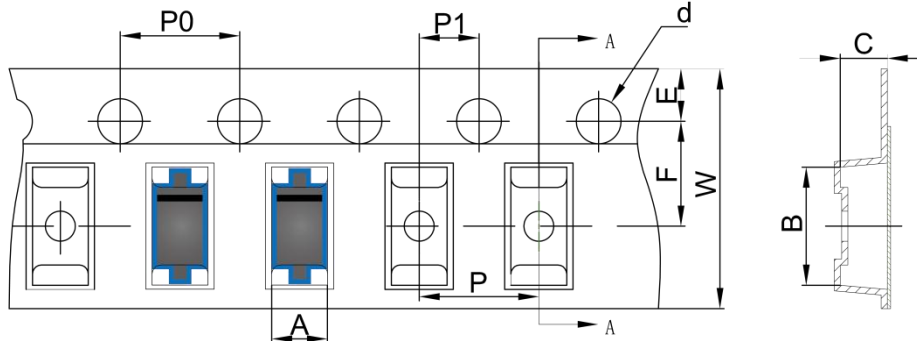

SOD-123 Tape Leader and Trailer

DIMENSIONS ARE IN MILLIMETER										
TYPE	A	B	C	d	E	F	P0	P	P1	W
SOD-123	1.85	3.95	1.57	Ø1.55	1.75	3.50	4.00	4.00	2.00	8.00
TOLERANCE	±0.1	±0.1	±0.1	±0.1	±0.1	±0.1	±0.1	±0.1	±0.1	±0.1

SOD-123 Reel

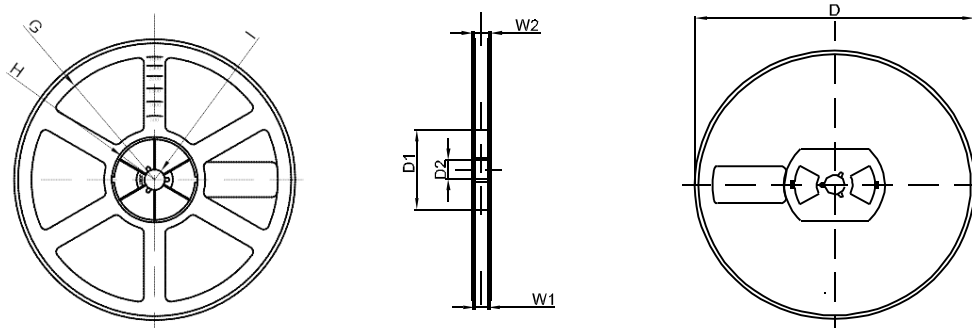
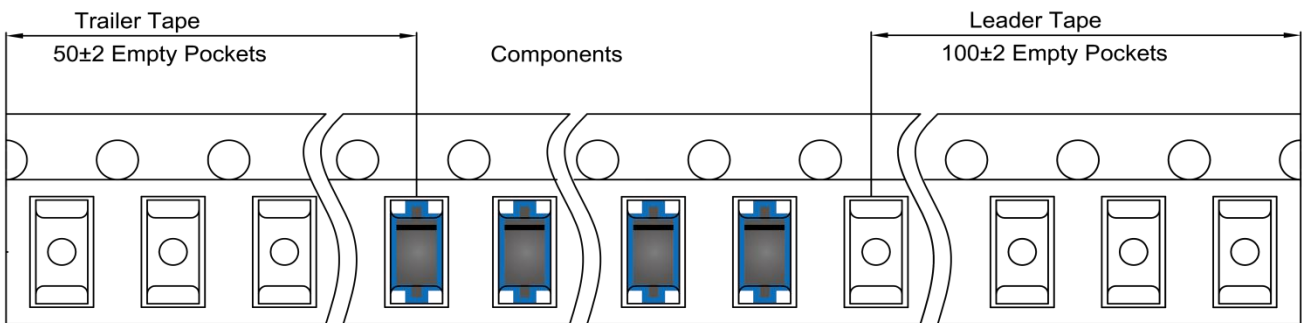

DIMENSIONS ARE IN MILLIMETER								
REEL OPTION	D	D1	D2	G	H	I	W1	W2
7" DIA	Ø178	54.40	13.00	R78	R25.60	R6.50	9.50	12.30
TOLERANCE	±2	±1	±1	±1	±1	±1	±1	±1