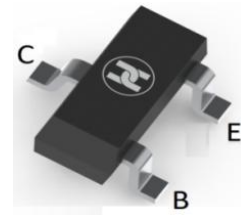
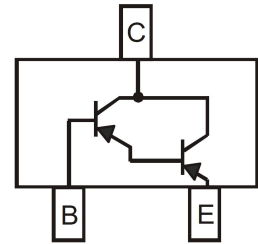

**DARLINGTON TRANSISTOR (PNP)**
**FEATURES**

- Complementary to MMBTA14
- High Current Gain
- Ideal for Medium Power Amplification and Switching
- Surface Mount device

**SOT-23**

**MECHANICAL DATA**

- Case: SOT-23
- Case Material: Molded Plastic. UL flammability
- Classification Rating: 94V-0
- Weight: 0.008 grams (approximate)

**MAXIMUM RATINGS (T<sub>A</sub> = 25°C unless otherwise noted)**

Parameter	Symbol	Value	Unit
Collector-Base Voltage	V <sub>CBO</sub>	-30	V
Collector-Emitter Voltage	V <sub>CEO</sub>	-30	V
Emitter-Base Voltage	V <sub>EBO</sub>	-10	V
Collector Current	I <sub>C</sub>	-500	mA
Collector Power Dissipation	P <sub>C</sub>	300	mW
Thermal Resistance From Junction To Ambient	R <sub>θJA</sub>	417	°C/W
Junction Temperature	T <sub>J</sub>	150	°C
Storage Temperature	T <sub>STG</sub>	-55 ~+150	°C

**ELECTRICAL CHARACTERISTICS (T<sub>A</sub> = 25°C unless otherwise specified)**

Parameter	Symbol	Min	Typ	Max	Unit	Conditions
Collector-base breakdown voltage	V <sub>(BR)CBO</sub>	-30			V	I <sub>C</sub> = -100μA, I <sub>E</sub> = 0
Collector-emitter breakdown voltage	V <sub>(BR)CEO</sub>	-30			V	I <sub>C</sub> = -100μA, I <sub>B</sub> = 0
Emitter-base breakdown voltage	V <sub>(BR)EBO</sub>	-10			V	I <sub>E</sub> = -100μA, I <sub>C</sub> = 0
Collector cut-off current	I <sub>CBO</sub>			-0.1	uA	V <sub>CB</sub> = -30V, I <sub>E</sub> = 0
Emitter cut-off current	I <sub>EBO</sub>			-0.1	uA	V <sub>EB</sub> = -10V, I <sub>C</sub> = 0
DC current gain	h <sub>FE1</sub>	10000				V <sub>CE</sub> = -5V, I <sub>C</sub> = -10mA
	h <sub>FE2</sub>	20000				V <sub>CE</sub> = -5V, I <sub>C</sub> = -100mA
Collector-emitter saturation voltage	V <sub>CE(sat)</sub>			-1.5	V	I <sub>C</sub> = -100mA, I <sub>B</sub> = -0.1mA
Base-emitter voltage	V <sub>BE</sub>			-2	V	I <sub>C</sub> = -100mA, V <sub>CE</sub> = -5V
Transition frequency	f <sub>T</sub>	125			MHz	V <sub>CE</sub> = -5V, I <sub>C</sub> = -10mA, f = 1MHz

\*Pulse test: pulse width ≤ 300μs, duty cycle ≤ 2%.

**DARLINGTON TRANSISTOR (PNP)**

**Typical Characteristics**

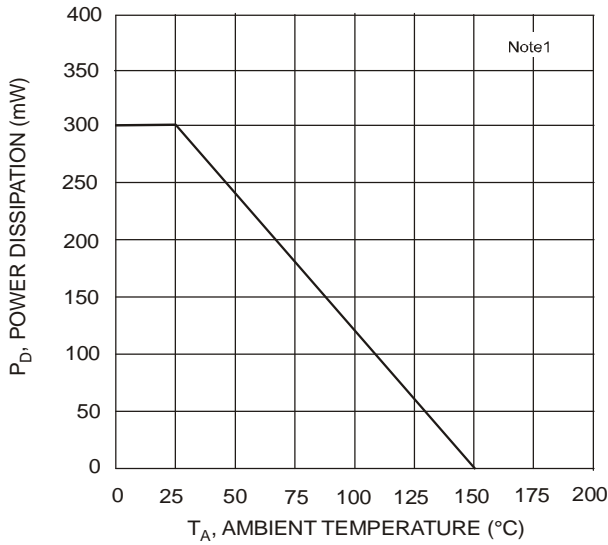

Fig. 1, Max Power Dissipation vs. Ambient Temperature

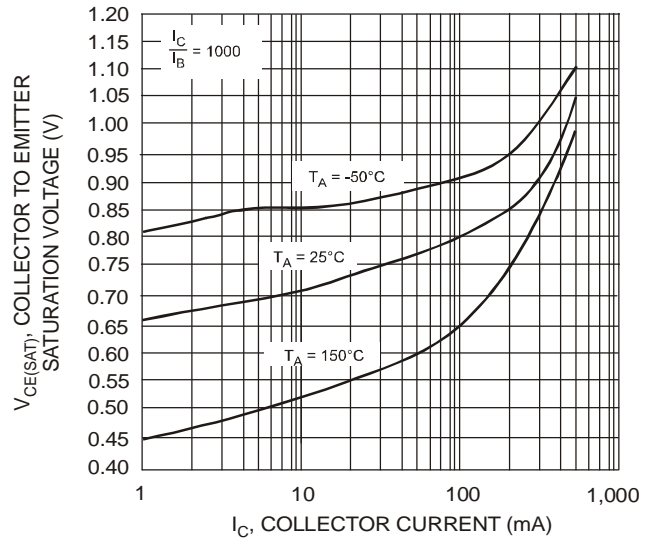

Fig. 2, Collector Emitter Saturation Voltage vs. Collector Current

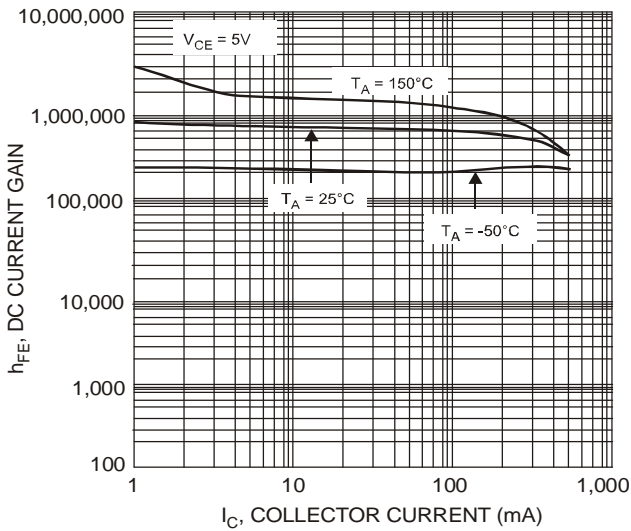

Fig. 3, DC Current Gain vs. Collector Current

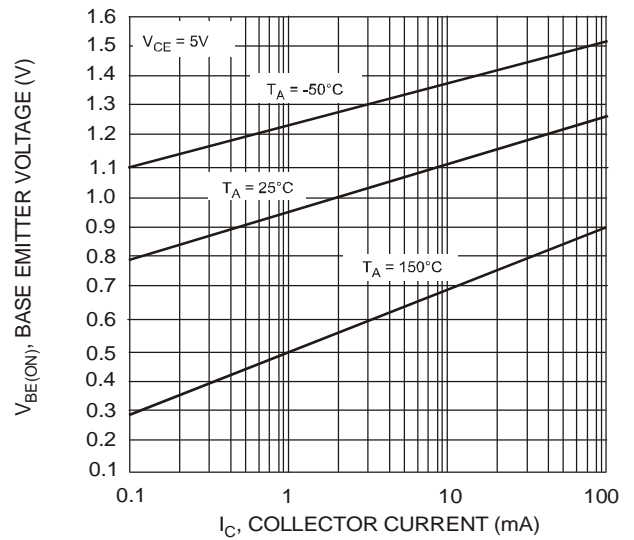

Fig. 4, Base Emitter Voltage vs. Collector Current

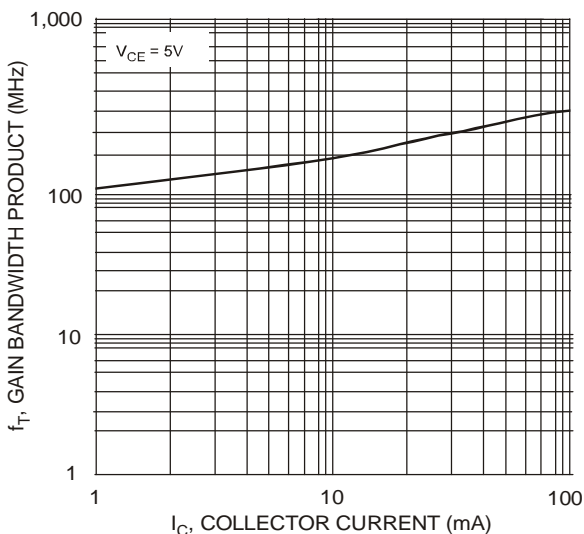

Fig. 5, Gain Bandwidth Product vs. Collector Current

**DARLINGTON TRANSISTOR (PNP)**

**SOT-23 Package Outline Dimensions**



Symbol	Dimensions In Millimeters		Dimensions In Inches	
	Min.	Max.	Min.	Max.
A	0.900	1.150	0.035	0.045
A1	0.000	0.100	0.000	0.004
A2	0.900	1.050	0.035	0.041
b	0.300	0.500	0.012	0.020
c	0.080	0.150	0.003	0.006
D	2.800	3.000	0.110	0.118
E	1.200	1.400	0.047	0.055
E1	2.250	2.550	0.089	0.100
e	0.950 TYP		0.037 TYP	
e1	1.800	2.000	0.071	0.079
L	0.550 REF		0.022 REF	
L1	0.300	0.500	0.012	0.020
θ	0°	8°	0°	8°

**SOT-23 Suggested Pad Layout**

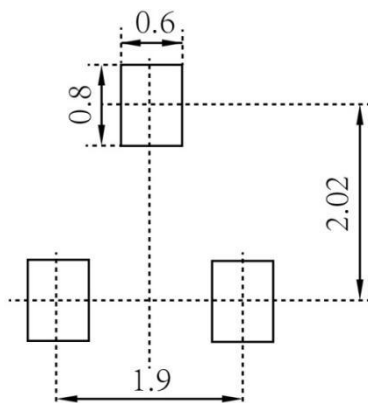

**Note:**

1. Controlling dimension: in millimeters
2. General tolerance:  $\pm 0.05\text{mm}$
3. The pad layout is for reference purposes only

**DARLINGTON TRANSISTOR (PNP)**

**SOT-23 Tape and Reel**

**SOT-23 Embossed Carrier Tape**

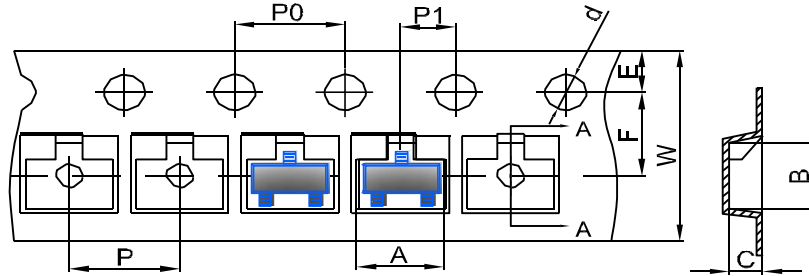

DIMENSIONS ARE IN MILLIMETER										
TYPE	A	B	C	d	E	F	P0	P	P1	W
SOT-23	3.15	2.77	1.22	Ø1.50	1.75	3.50	4.00	4.00	2.00	8.00
TOLERANCE	±0.1	±0.1	±0.1	±0.1	±0.1	±0.1	±0.1	±0.1	±0.1	±0.1

**SOT-23 Tape Leader and Trailer**

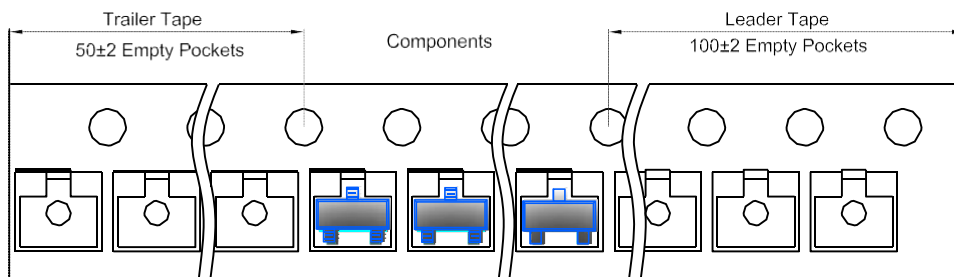

**SOT-23 Reel**

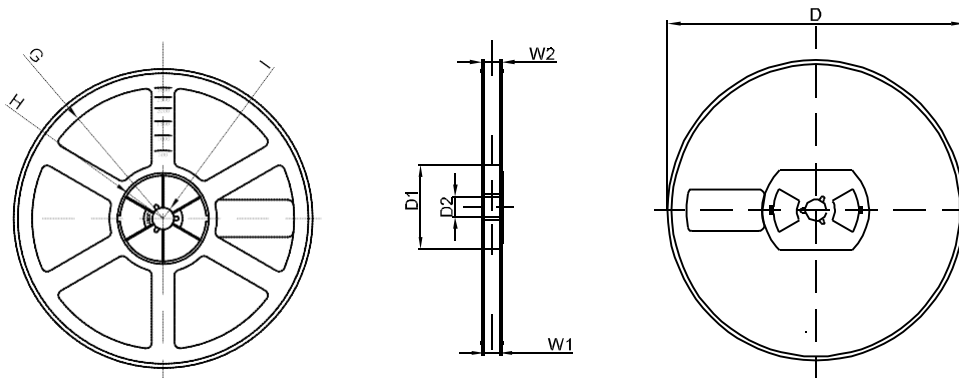

DIMENSIONS ARE IN MILLIMETER								
REEL OPTION	D	D1	D2	G	H	I	W1	W2
7" DIA	Ø178	54.40	13.00	R78	R25.60	R6.50	9.50	12.30
TOLERANCE	±2	±1	±1	±1	±1	±1	±1	±1