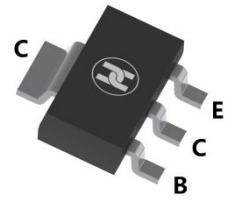
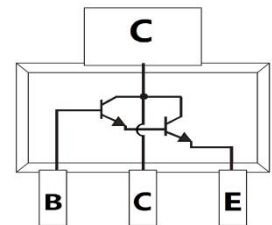

**BIPOLAR TRANSISTOR (NPN)**
**FEATURES**

- Complementary to PZTA63
- Low Voltage and High Current
- Pre-amplifiers requiring high input impedance
- Surface Mount device

**SOT-223**

**MECHANICAL DATA**

- Case: SOT-223
- Case Material: Molded Plastic. UL flammability
- Classification Rating: 94V-0
- Weight: 0.04 grams (approximate)

**MAXIMUM RATINGS (T<sub>A</sub> = 25°C unless otherwise noted)**

Parameter	Symbol	Value	Unit
Collector-Base Voltage	V <sub>CBO</sub>	30	V
Collector-Emitter Voltage	V <sub>CEO</sub>	30	V
Emitter-Base Voltage	V <sub>EBO</sub>	10	V
Collector Current	I <sub>C</sub>	500	mA
Collector Power Dissipation	P <sub>C</sub>	1	W
Junction Temperature	T <sub>J</sub>	150	°C
Storage Temperature	T <sub>STG</sub>	-65 ~+150	°C

**ELECTRICAL CHARACTERISTICS (T<sub>A</sub> = 25°C unless otherwise specified)**

Parameter	Symbol	Min	Typ	Max	Unit	Conditions
Collector-base breakdown voltage	V <sub>(BR)CBO</sub>	30			V	I <sub>C</sub> =100μA, I <sub>E</sub> =0
Collector-emitter breakdown voltage	V <sub>(BR)CEO</sub>	30			V	I <sub>C</sub> =100μA, I <sub>B</sub> =0
Emitter-base breakdown voltage	V <sub>(BR)EBO</sub>	10			V	I <sub>E</sub> =100μA, I <sub>C</sub> =0
Collector cut-off current	I <sub>CBO</sub>			100	nA	V <sub>CB</sub> =30V, I <sub>E</sub> =0
Base cut-off current	I <sub>CEO</sub>			100	nA	V <sub>EB</sub> =10V, I <sub>C</sub> =0
DC current gain	h <sub>FE</sub>	5000				V <sub>CE</sub> =5V, I <sub>C</sub> =10mA
		10000				V <sub>CE</sub> =5V, I <sub>C</sub> =100mA
Collector-emitter saturation voltage	V <sub>CE(sat)</sub>			1.5	V	I <sub>C</sub> =100mA, I <sub>B</sub> =0.1mA
Base-emitter voltage	V <sub>BE</sub>			2	V	V <sub>CE</sub> =5V, I <sub>C</sub> =100mA
Transition frequency	f <sub>T</sub>	125			MHz	V <sub>CE</sub> =5V, I <sub>C</sub> =10mA, f=100MHz

**MARKING: PZTA13**

**BIPOLAR TRANSISTOR (NPN)**

**Typical Characteristics**

**Total power dissipation**  $P_{tot} = f(T_A^*; T_S)$

\* Package mounted on epoxy

**Transition frequency**  $f_T = f(I_C)$

$V_{CE} = 5\text{ V}, f = 100\text{ MHz}$

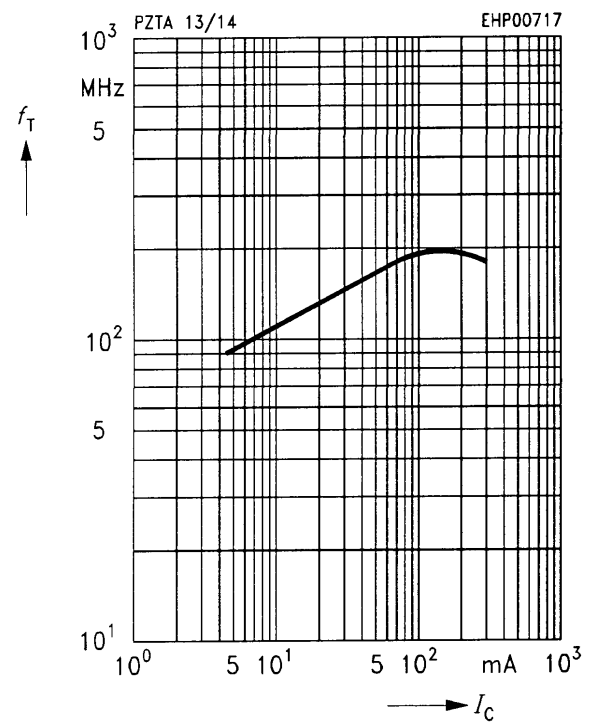
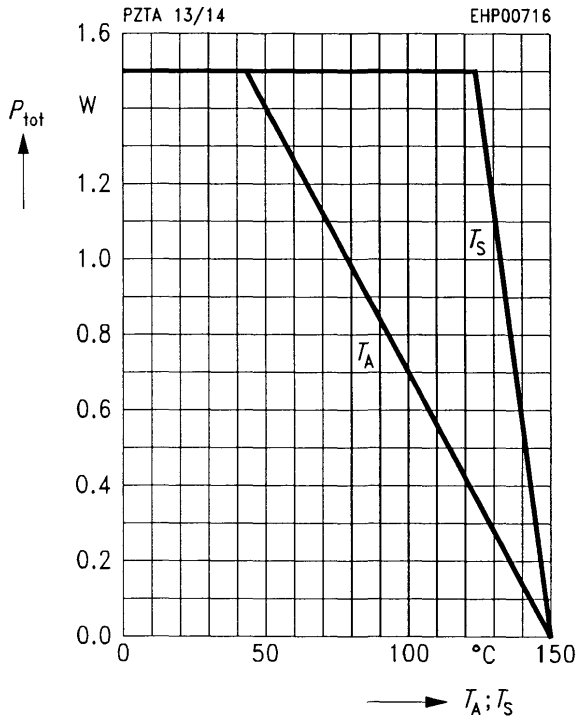

**Collector cutoff current**  $I_{CB0} = f(T_A)$

$V_{CE} = 30\text{ V}$

**DC current gain**  $h_{FE} = f(I_C)$

$V_{CE} = 5\text{ V}$

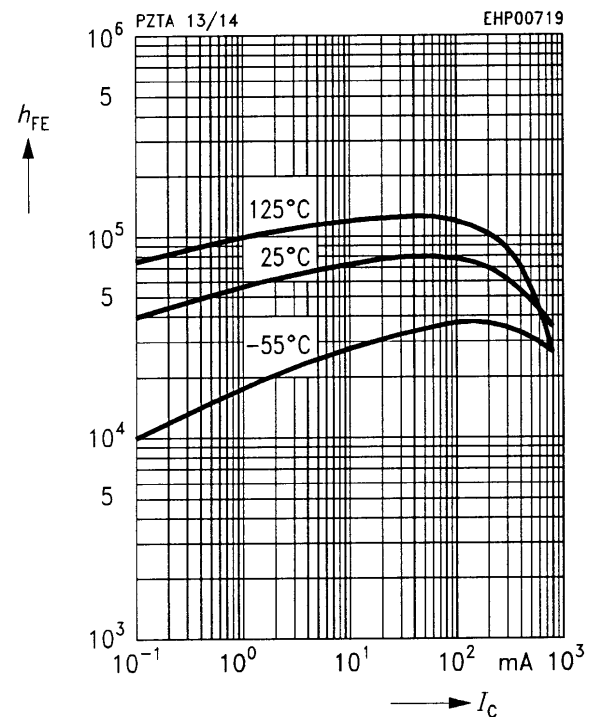
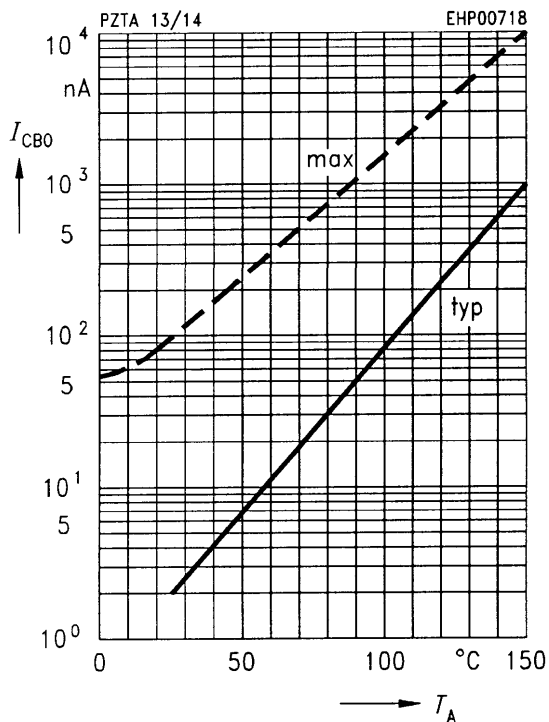

**BIPOLAR TRANSISTOR (NPN)**

**Collector-emitter saturation voltage**

$I_C = f(V_{CE\ sat})$

$h_{FE} = 1000$

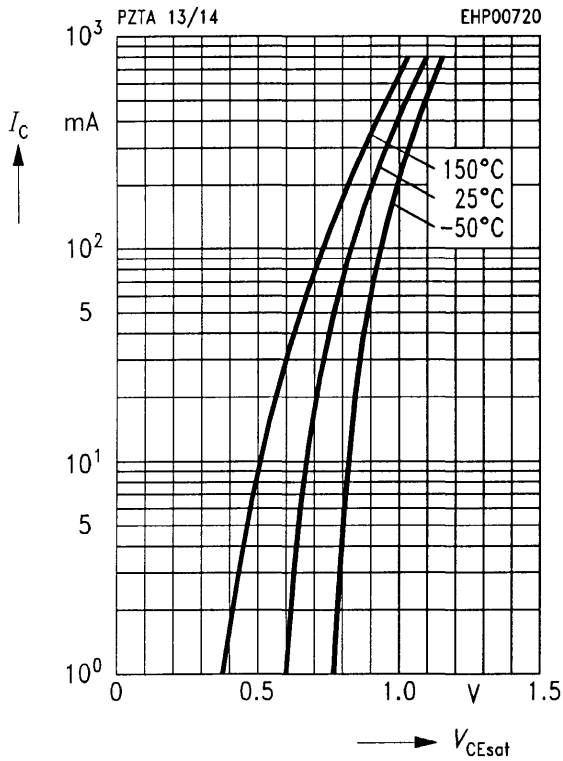

**Base-emitter saturation voltage**

$I_C = f(V_{BE\ sat})$

$h_{FE} = 1000$

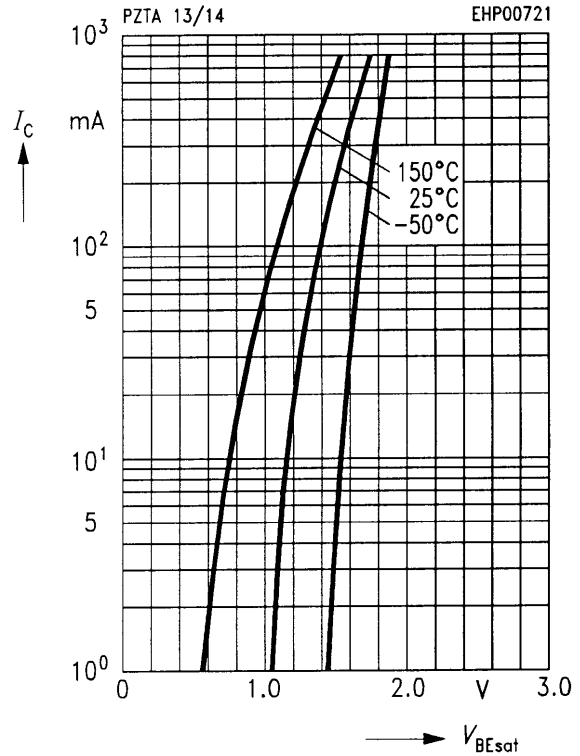

**Permissible pulse load  $P_{tot\ max} / P_{tot\ DC} = f(t_p)$**

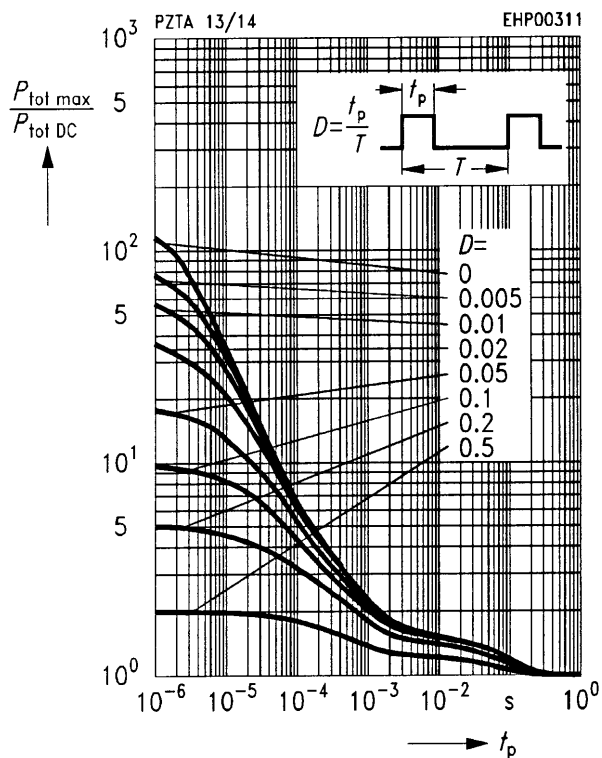

**BIPOLAR TRANSISTOR (NPN)**

**SOT-223 Package Outline Dimensions**

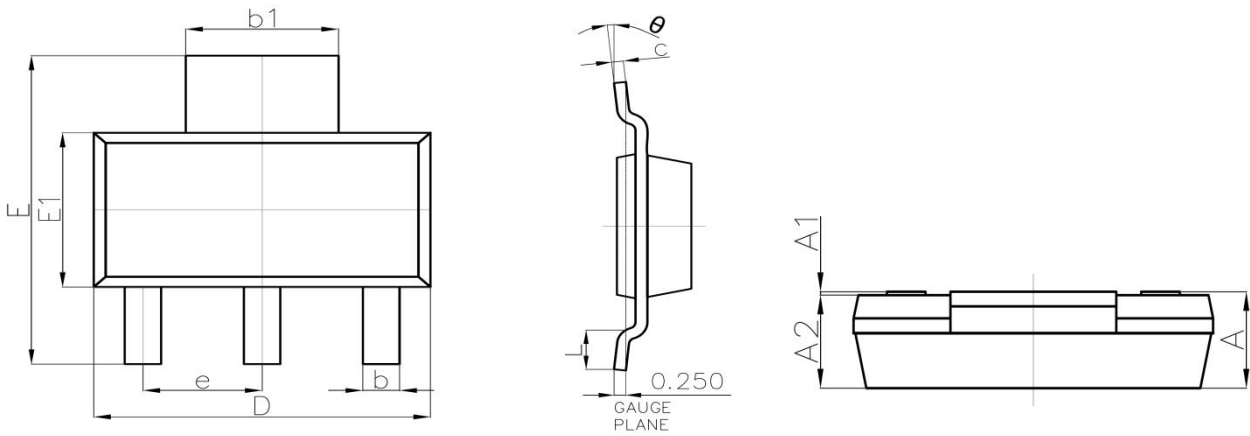

Symbol	Dimensions In Millimeters		Dimensions In Inches	
	Min.	Max.	Min.	Max.
A	—	1.800	-----	0.071
A1	0.020	0.100	0.001	0.004
A2	1.500	1.700	0.059	0.067
b	0.660	0.840	0.026	0.033
b1	2.900	3.100	0.114	0.122
c	0.230	0.350	0.009	0.014
D	6.300	6.700	0.248	0.264
E	6.700	7.300	0.264	0.287
E1	3.300	3.700	0.130	0.146
e	2.300(BSC)		0.091(BSC)	
L	0.750	-----	0.030	-----
θ	0°	10°	0°	10°

**SOT-223 Suggested Pad Layout**

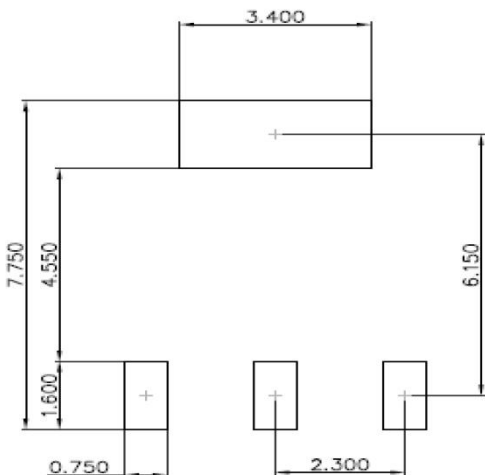

**Note:**

1. Controlling dimension: in millimeters
2. General tolerance: ±0.05mm
3. The pad layout is for reference purposes only

**BIPOLAR TRANSISTOR (NPN)**

**SOT-223 Tape and Reel**

**SOT-223 Embossed Carrier Tape**

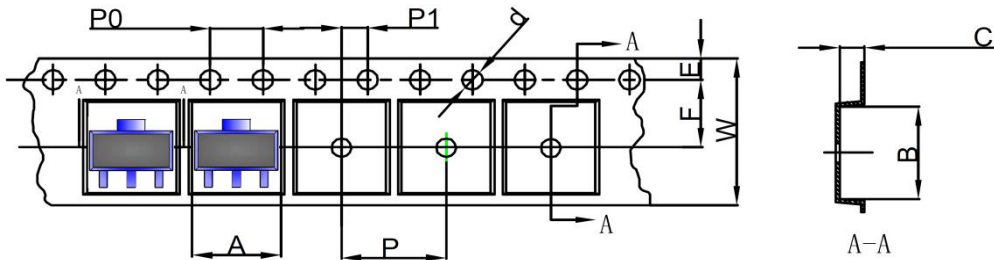

DIMENSIONS ARE IN MILLIMETER										
TYPE	A	B	C	d	E	F	P0	P	P1	W
SOT-223	6.765	7.335	1.88	Ø1.50	1.75	5.50	4.00	4.00	2.00	12.00
TOLERANCE	±0.1	±0.1	±0.1	±0.1	±0.1	±0.1	±0.1	±0.1	±0.1	±0.1

**SOT-223 Tape Leader and Trailer**

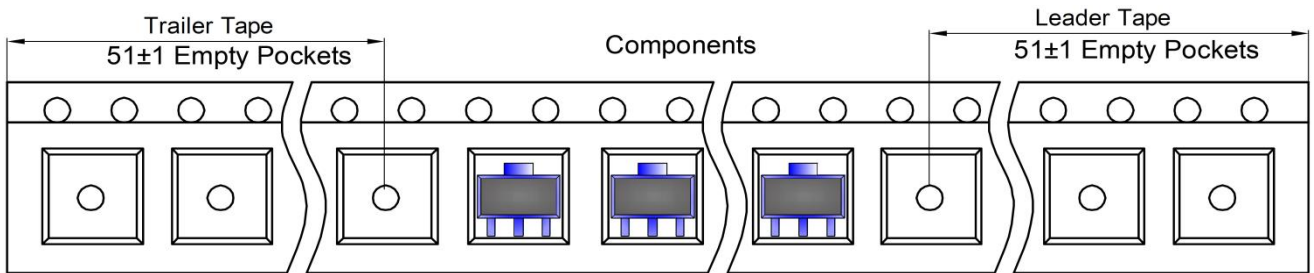

**SOT-223 Reel**

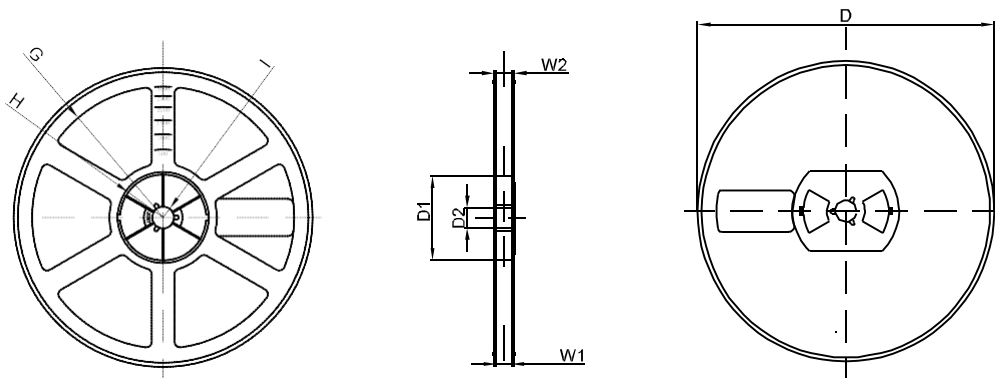

DIMENSIONS ARE IN MILLIMETER								
REEL OPTION	D	D1	D2	G	H	I	W1	W2
13" DIA	Ø330.00	100.00	13.00	R151.00	R56.00	R6.50	12.40	17.60
TOLERANCE	±2	±1	±1	±1	±1	±1	±1	±1