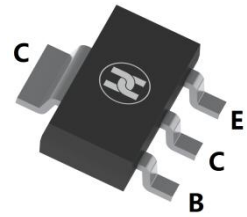
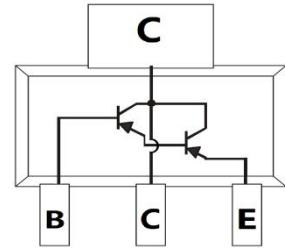

DARLINGTON TRANSISTOR (PNP)
FEATURES

- Complementary to PZTA13
- Low Voltage and High Current
- High Current Gain Applications
- Surface Mount device

SOT-223

MECHANICAL DATA

- Case: SOT-223
- Case Material: Molded Plastic. UL flammability
- Classification Rating: 94V-0
- Weight: 0.04 grams (approximate)

MAXIMUM RATINGS (T_A = 25°C unless otherwise noted)

Parameter	Symbol	Value	Unit
Collector-Base Voltage	V _{CB0}	-30	V
Collector-Emitter Voltage	V _{CEO}	-30	V
Emitter-Base Voltage	V _{EBO}	-10	V
Collector Current	I _C	-500	mA
Collector Power Dissipation	P _C	1	W
Thermal Resistance From Junction To Ambient	R _{θJA}	125	°C/W
Junction Temperature	T _J	150	°C
Storage Temperature	T _{STG}	-55 ~+150	°C

ELECTRICAL CHARACTERISTICS (T_A = 25°C unless otherwise specified)

Parameter	Symbol	Min	Typ	Max	Unit	Conditions
Collector-base breakdown voltage	V _{(BR)CBO}	-30			V	I _C = -100μA, I _E = 0
Collector-emitter breakdown voltage	V _{(BR)CEO}	-30			V	I _C = -100μA, I _B = 0
Emitter-base breakdown voltage	V _{(BR)EBO}	-5			V	I _E = -10μA, I _C = 0
Collector cut-off current	I _{CB0}			-0.1	μA	V _{CB} = -30V, I _E = 0
Emitter cut-off current	I _{EBO}			-0.1	μA	V _{EB} = -10V, I _C = 0
DC current gain	h _{FE} *	5000				V _{CE} = -5V, I _C = -10mA
		10000				V _{CE} = -5V, I _C = -100mA
Collector-emitter saturation voltage	V _{CE(sat)} *			-1.5	V	I _C = -100mA, I _B = -0.1mA
Base-emitter saturation voltage	V _{BE} *			-2	V	I _C = -100mA, V _{CE} = -5V
Transition frequency	f _T	125			MHz	V _{CE} = -5V, I _C = -10mA, f = 100MHz

*Pulse test: pulse width ≤ 350μs, duty cycle ≤ 2%.

MARKING: PZTA63

DARLINGTON TRANSISTOR (PNP)

Typical Characteristics

Total power dissipation $P_{tot} = f(T_A^*; T_S)$

* Package mounted on epoxy

Transition frequency $f_T = f(I_C)$

$V_{CE} = 5\text{ V}, f = 100\text{ MHz}$

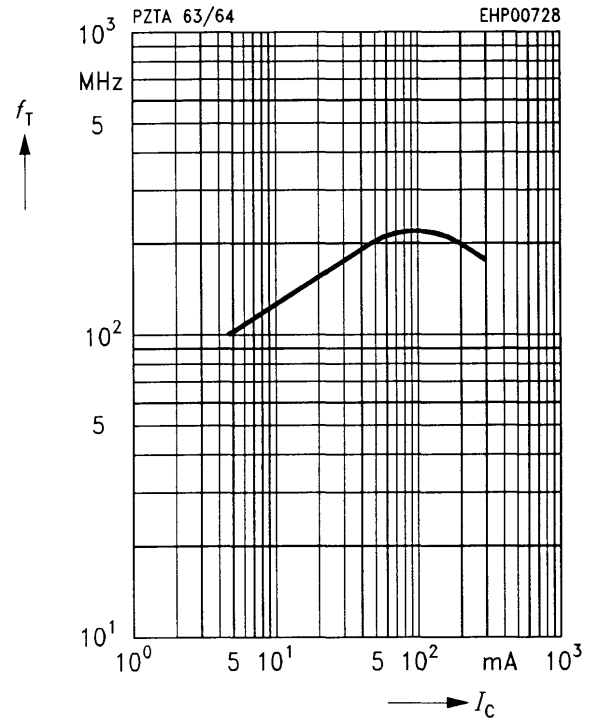
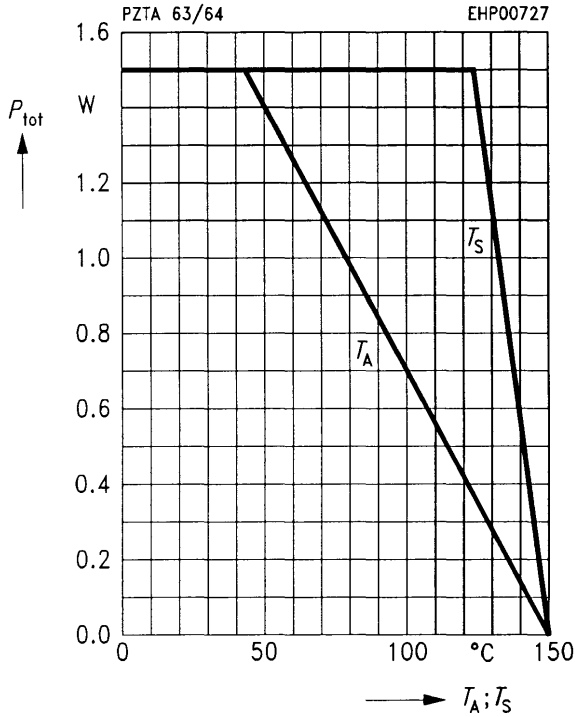

Permissible pulse load $P_{tot\ max} / P_{tot\ DC} = f(t_p)$

DC current gain $h_{FE} = f(I_C)$

$V_{CE} = 5\text{ V}$

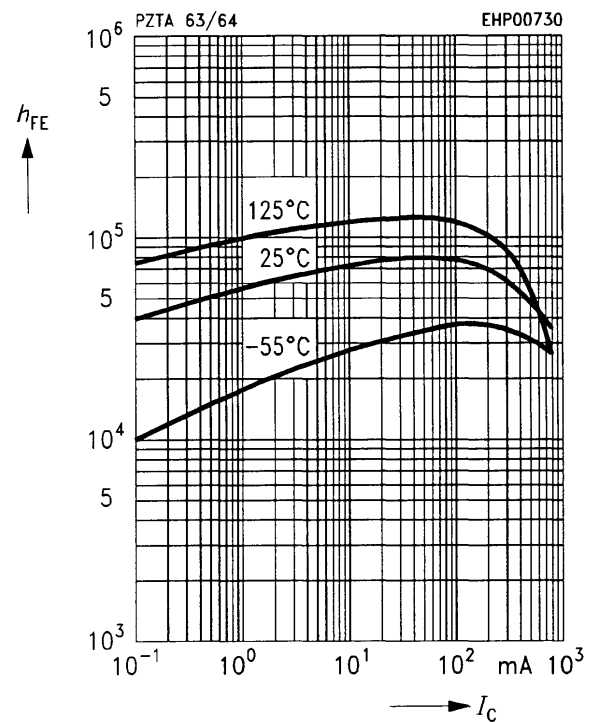
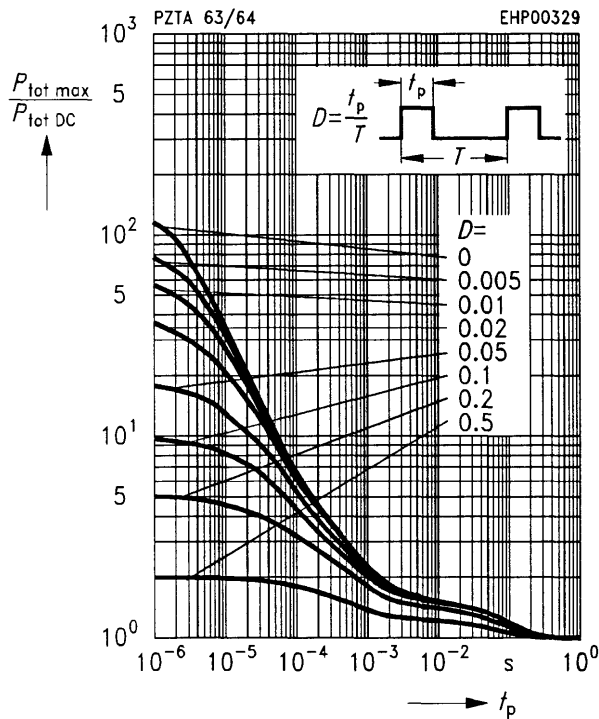

DARLINGTON TRANSISTOR (PNP)

Collector-emitter saturation voltage

$I_C = f(V_{CE\ sat})$

$h_{FE} = 1000$

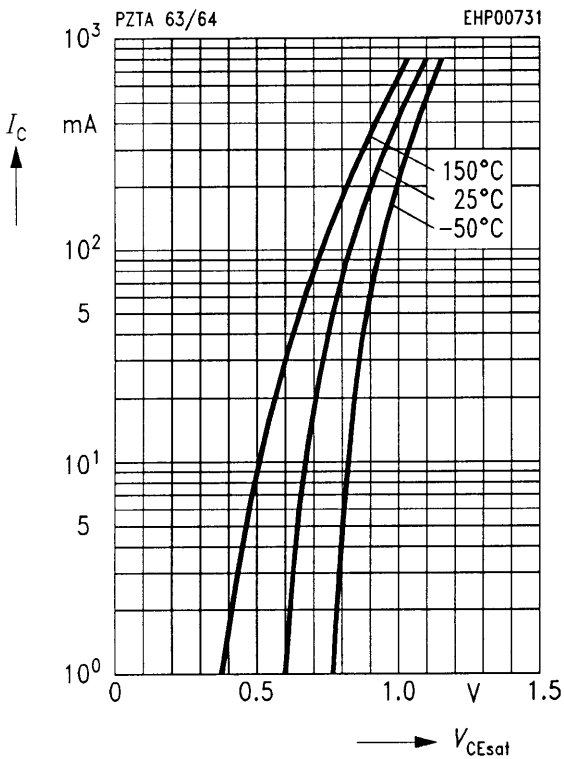

Base-emitter saturation voltage

$I_C = f(V_{BE\ sat})$

$h_{FE} = 1000$

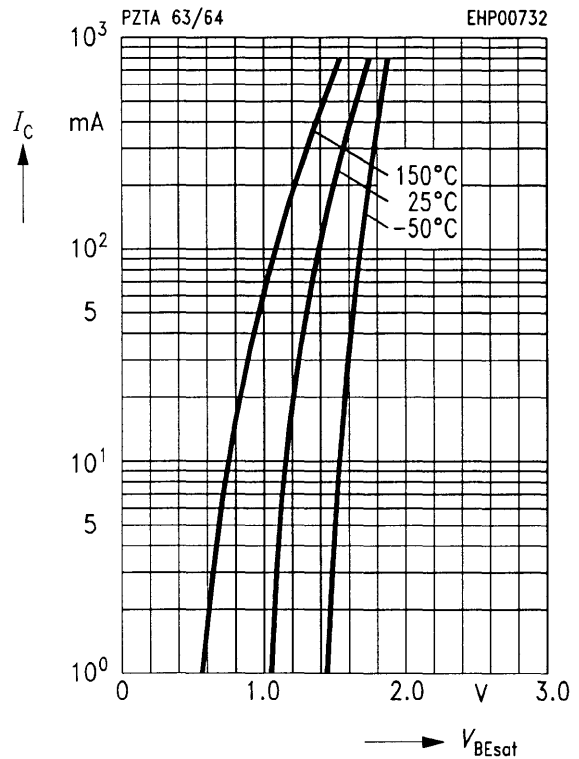

Collector cutoff current $I_{CB0} = f(T_A)$

$V_{CE} = 30\ V$

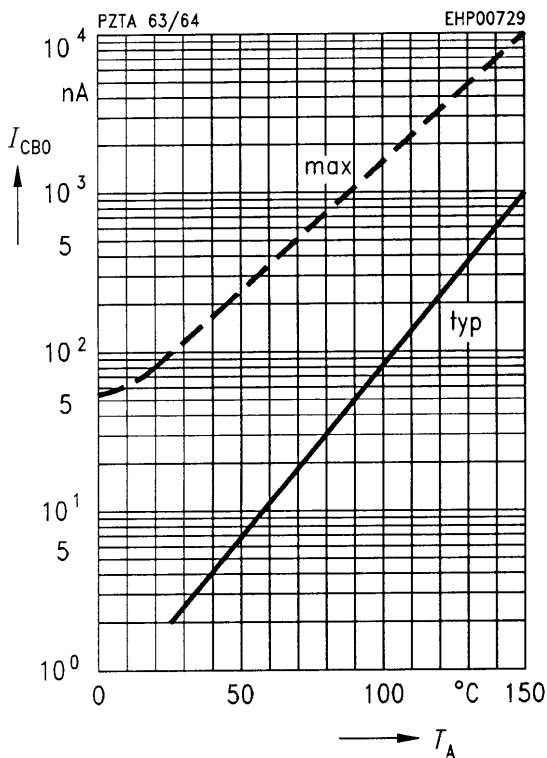

DARLINGTON TRANSISTOR (PNP)

SOT-223 Package Outline Dimensions

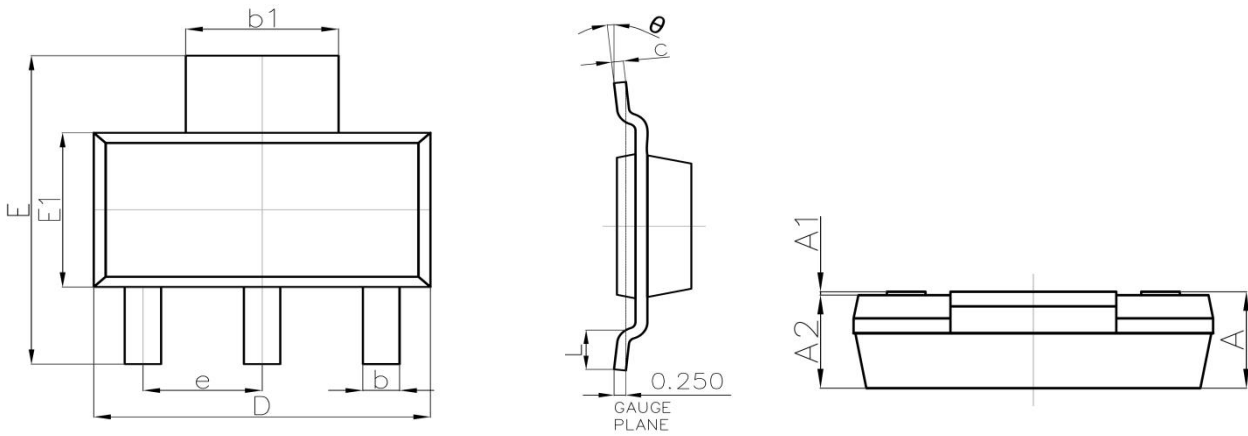

Symbol	Dimensions In Millimeters		Dimensions In Inches	
	Min.	Max.	Min.	Max.
A	—	1.800	-----	0.071
A1	0.020	0.100	0.001	0.004
A2	1.500	1.700	0.059	0.067
b	0.660	0.840	0.026	0.033
b1	2.900	3.100	0.114	0.122
c	0.230	0.350	0.009	0.014
D	6.300	6.700	0.248	0.264
E	6.700	7.300	0.264	0.287
E1	3.300	3.700	0.130	0.146
e	2.300(BSC)		0.091(BSC)	
L	0.750	-----	0.030	-----
θ	0°	10°	0°	10°

SOT-223 Suggested Pad Layout

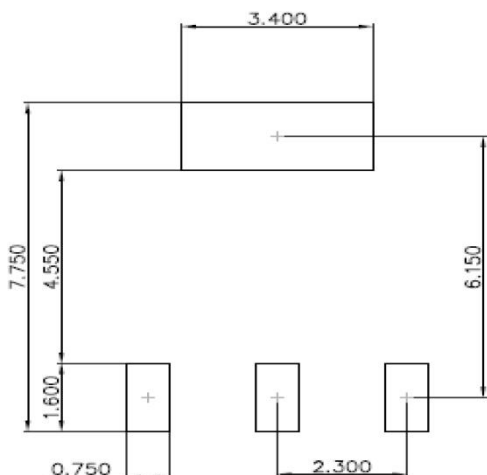

Note:

1. Controlling dimension: in millimeters
2. General tolerance: $\pm 0.05\text{mm}$
3. The pad layout is for reference purposes only

DARLINGTON TRANSISTOR (PNP)

SOT-223 Tape and Reel

SOT-223 Embossed Carrier Tape

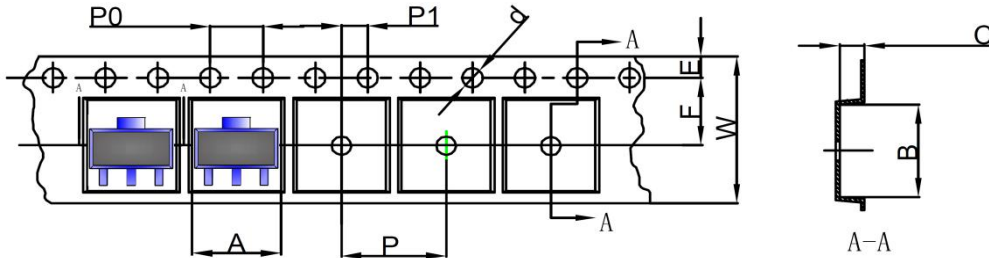

DIMENSIONS ARE IN MILLIMETER										
TYPE	A	B	C	d	E	F	P0	P	P1	W
SOT-223	6.765	7.335	1.88	Ø1.50	1.75	5.50	4.00	4.00	2.00	12.00
TOLERANCE	±0.1	±0.1	±0.1	±0.1	±0.1	±0.1	±0.1	±0.1	±0.1	±0.1

SOT-223 Tape Leader and Trailer

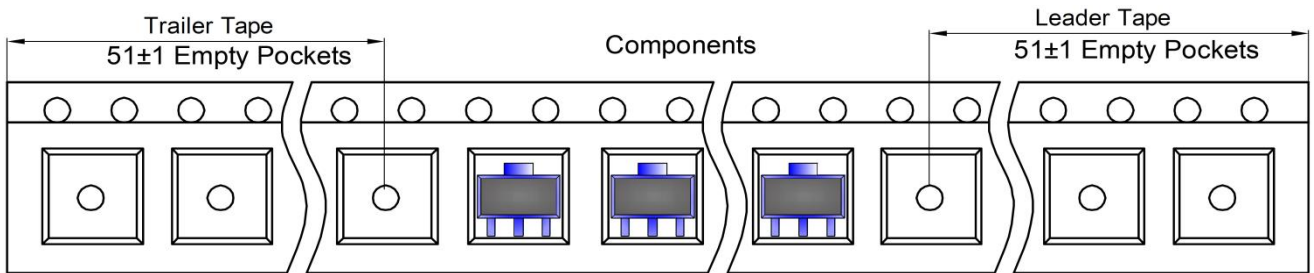

SOT-223 Reel

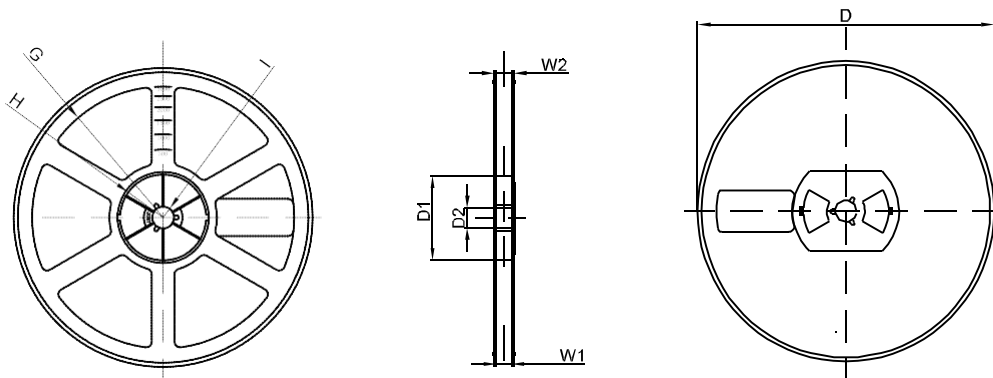

DIMENSIONS ARE IN MILLIMETER								
REEL OPTION	D	D1	D2	G	H	I	W1	W2
13" DIA	Ø330.00	100.00	13.00	R151.00	R56.00	R6.50	12.40	17.60
TOLERANCE	±2	±1	±1	±1	±1	±1	±1	±1