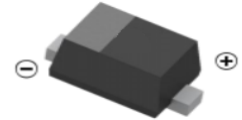
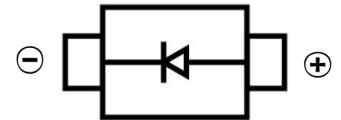

**SCHOTTKY BARRIER DIODE**
**FEATURES**

- Low Forward Voltage
- Low Reverse voltage leakage current
- Small Surface Mount device
- For Low Current Rectifier Circuits Applications

**SOD-523**
**MECHANICAL DATA**

- Case: SOD-523
- Case Material: Molded Plastic. UL Iammability
- Classification Rating: 94V-0
- Weight: 0.0015 grams (approximate)

**MAXIMUM RATINGS (T<sub>A</sub> = 25°C unless otherwise noted)**

Parameter	Symbol	Value	Unit
Reverse Voltage	V <sub>R</sub>	30	V
Non-Repetitive Peak Forward Surge Current @ t = 8.3 ms	I <sub>FSM</sub>	1	A
Mean rectifying current	I <sub>o</sub>	200	mA
Power Dissipation	P <sub>D</sub>	150	mW
Thermal Resistance From Junction To Ambient	R <sub>θJA</sub>	667	°C/W
Junction Temperature	T <sub>J</sub>	125	°C
Storage Temperature	T <sub>STG</sub>	-55 ~+150	°C

**ELECTRICAL CHARACTERISTICS (T<sub>A</sub> = 25°C unless otherwise specified)**

Parameter	Symbol	Min	Max	Unit	Conditions
Forward voltage	V <sub>F</sub>		0.60	V	I <sub>F</sub> =200mA
Reverse voltage leakage current	I <sub>R</sub>		1	uA	V <sub>R</sub> =10V

SCHOTTKY BARRIER DIODE

Typical Characteristics

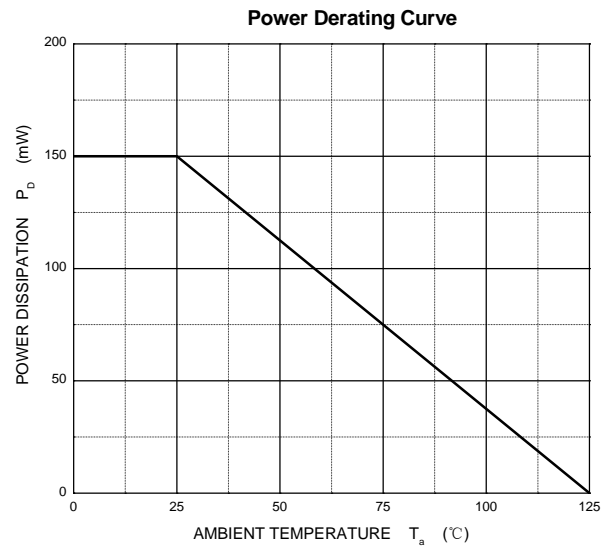
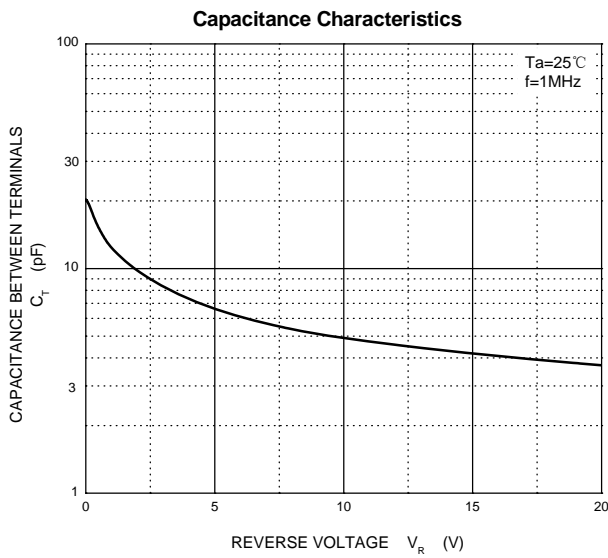
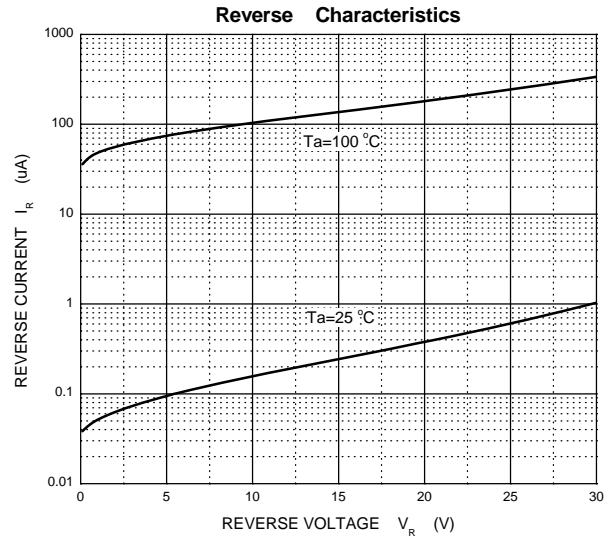
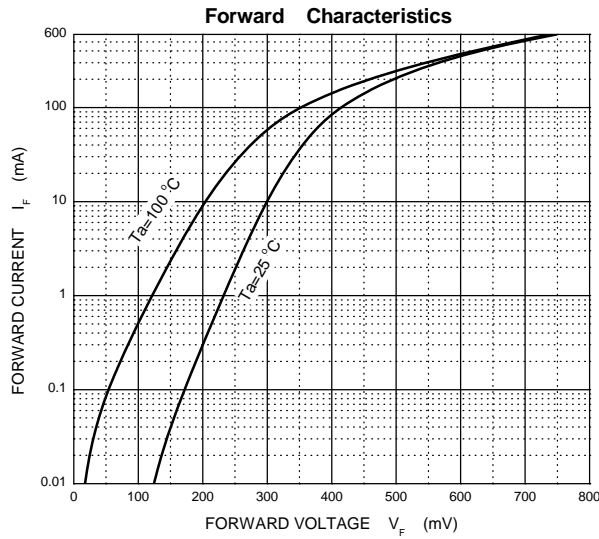

SCHOTTKY BARRIER DIODE

**SOD-523 Package Outline Dimensions**

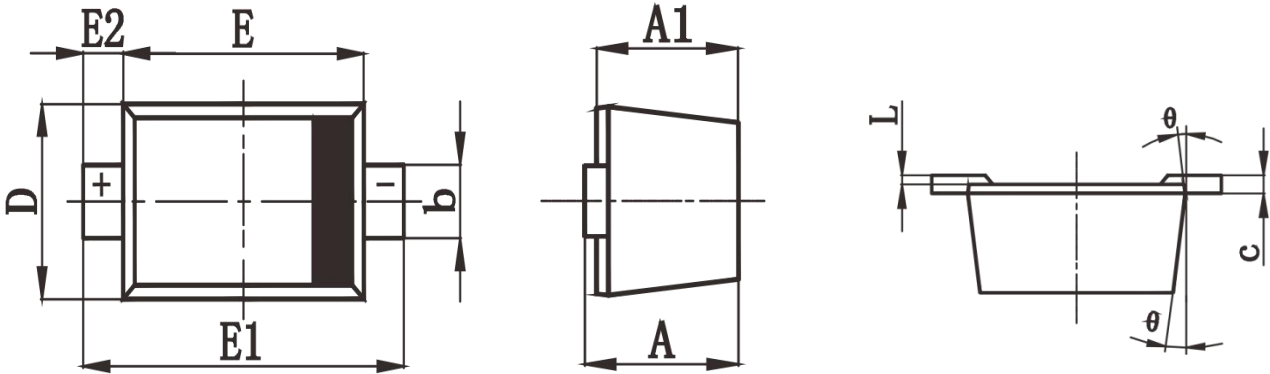

Symbol	Dimensions In Millimeters		Dimensions In Inches	
	Min.	Max.	Min.	Max.
A	0.510	0.770	0.020	0.031
A1	0.010	0.070	0.001	0.003
A2	0.500	0.700	0.020	0.028
b	0.250	0.350	0.010	0.014
c	0.080	0.150	0.003	0.006
D	0.750	0.850	0.030	0.033
E	1.100	1.300	0.043	0.051
E1	1.500	1.700	0.059	0.067
L	0.200 REF		0.008 REF	
L1	0.250	0.400	0.010	0.016
θ	0°	8°	0°	8°

**SOD-523 Suggested Pad Layout**

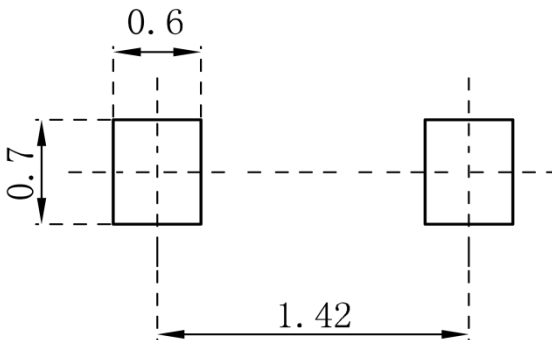

**Note:**

1. Controlling dimension: in millimeters
2. General tolerance:  $\pm 0.05\text{mm}$
3. The pad layout is for reference purposes only

SCHOTTKY BARRIER DIODE

**SOD-523 Tape and Reel**

**SOD-523 Embossed Carrier Tape**

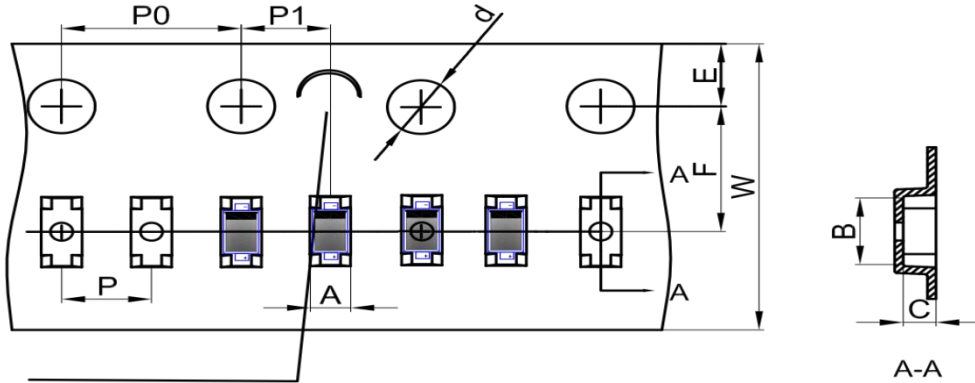

NOTE: TO CAVE 'C' ON CARRIER TAPE PER 120MM

DIMENSIONS ARE IN MILLIMETER										
TYPE	A	B	C	d	E	F	P0	P	P1	W
SOD-523	0.90	1.94	0.73	Ø1.50	1.75	3.50	4.00	2.00	2.00	8.00
TOLERANCE	±0.1	±0.1	±0.1	±0.1	±0.1	±0.1	±0.1	±0.1	±0.1	±0.1

**SOD-523 Tape Leader and Trailer**

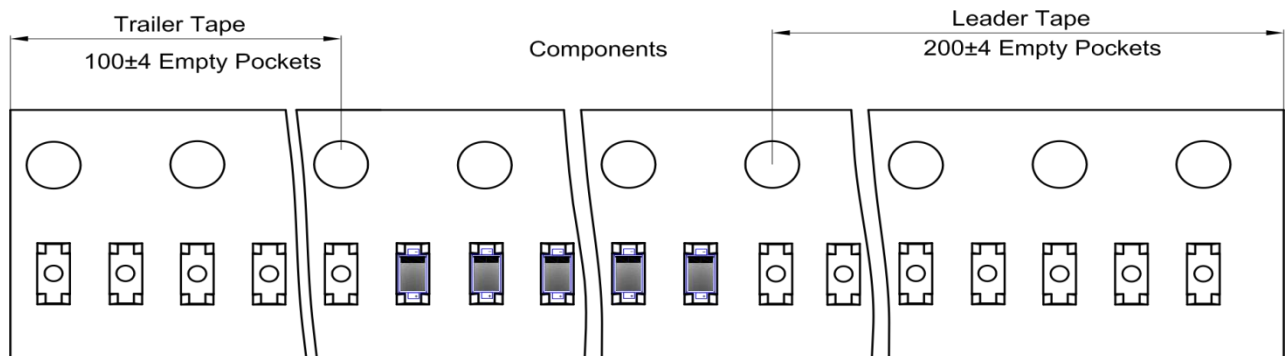

**SOD-523 Reel**

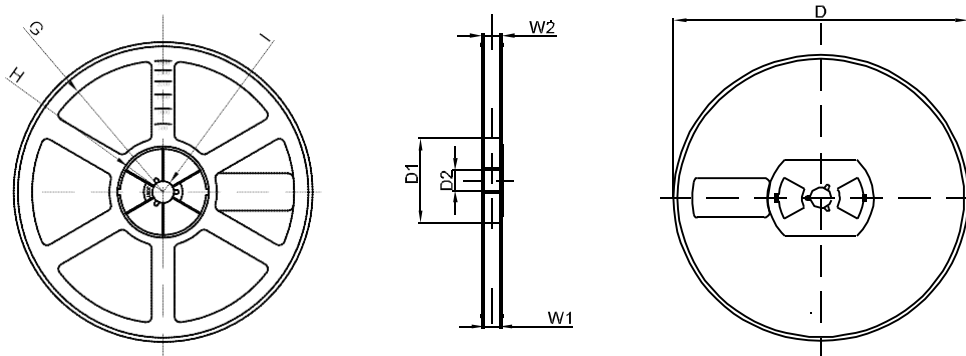

DIMENSIONS ARE IN MILLIMETER								
REEL OPTION	D	D1	D2	G	H	I	W1	W2
7" DIA	Ø178	54.40	13.00	R78	R25.60	R6.50	9.50	12.30
TOLERANCE	±2	±1	±1	±1	±1	±1	±1	±1