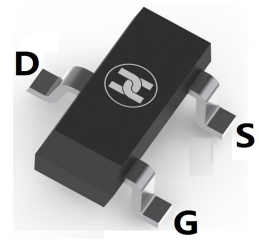
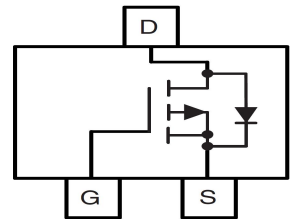

**LOW VOLTAGE MOSFET (P-CHANNEL)**
**FEATURES**

- $V_{DS}=-8V, R_{DS(ON)}\leq 45m\Omega @ V_{GS}=-4.5V, I_D=-3.0A$
- Low on-resistance
- For DC to DC converter and Load switch applications
- Surface Mount device

**SOT-23**

**MECHANICAL DATA**

- Case: SOT-23
- Case Material: Molded Plastic. UL flammability
- Classification Rating: 94V-0
- Weight: 0.008 grams (approximate)

**MAXIMUM RATINGS ( $T_A = 25^\circ C$  unless otherwise noted)**

Parameter	Symbol	Value	Unit
Drain-source voltage	$V_{DS}$	-8	V
Gate-source voltage	$V_{GS}$	$\pm 8$	V
Continuous drain current	$I_D$	-3.0	A
Pulsed drain current	$I_{DM}$	-10	A
Continuous Source-Drain Diode current	$I_S$	-0.6	A
Power dissipation	$P_D$	0.71	W
Thermal resistance from Junction to ambient	$R_{\theta JA}$	175	$^\circ C/W$
Junction temperature	$T_J$	150	$^\circ C$
Storage temperature	$T_{STG}$	-55 ~+150	$^\circ C$

**ELECTRICAL CHARACTERISTICS ( $T_A = 25^\circ C$  unless otherwise specified)**

Parameter	Symbol	Min	Typ	Max	Unit	Conditions
Drain-Source breakdown voltage	$V_{(BR)DSS}$	-8			V	$V_{GS}=0V, I_D=-10\mu A$
Zero gate voltage drain current	$I_{DSS}$			-1	$\mu A$	$V_{DS}=-6.4V, V_{GS}=0V$
				-10	$\mu A$	$V_{DS}=-6.4V, V_{GS}=0V, T_J=55^\circ C$
Gate-body leakage current	$I_{GSS}$			$\pm 100$	nA	$V_{DS}=0V, V_{GS}=\pm 8V$
Gate-threshold voltage	$V_{GS(th)}$	-0.45		-0.8	V	$V_{DS}=V_{GS}, I_D=-250\mu A$
On-state Drain Current	$I_{D(on)}$	-6				$V_{DS}\leq -5V, V_{GS}=-4.5V$
		-3				$V_{DS}\leq -5V, V_{GS}=-2.5V$
Drain-source on-resistance (note 1)	$R_{DS(ON)}$		36	45	m $\Omega$	$V_{GS}=-4.5V, I_D=-3.5A$
			58	72	m $\Omega$	$V_{GS}=-2.5V, I_D=-3A$
			96	120	m $\Omega$	$V_{GS}=-1.8V, I_D=-0.7A$
Forward transconductance (note 1)	$g_{FS}$		9		S	$V_{DS}=-5V, I_D=-3.5A$
Input capacitance (note 1)	$C_{iss}$		970		pF	$V_{DS}=-4V, V_{GS}=0V, f=1MHz$
Output capacitance (note 1)	$C_{oss}$		485		pF	
Reverse transfer capacitance (note 1)	$C_{rss}$		160		pF	
Turn-on delay time (note 1)	$t_{d(on)}$		18	25	nS	$V_{DD}=-4V, I_D=-1A,$ $V_{GEN}=-4.5V, R_g=6\Omega, R_L=4\Omega$
Turn-on rise time (note 1)	$t_r$		45	65	nS	
Turn-off delay time (note 1)	$t_{d(off)}$		40	60	nS	
Turn-off fall time (note 1)	$t_f$		45	65	nS	
Total gate charge (note 1)	$Q_g$		8.5	12	nC	$V_{DS}=-4V, V_{GS}=-4.5V, I_D=-3.5A$
Gate-source charge (note 1)	$Q_{gs}$		1.5		nC	
Gate-drain charge (note 1)	$Q_{gd}$		2.1		nC	
Diode forward voltage (note 1)	$V_{SD}$			-1.2	V	$I_S=-0.8A, V_{GS}=0V$

Note: 1. Pulse test ; Pulse width  $\leq 300\mu s$ , Duty cycle  $\leq 2\%$  .

**LOW VOLTAGE MOSFET (P-CHANNEL)**

**Typical Characteristics**

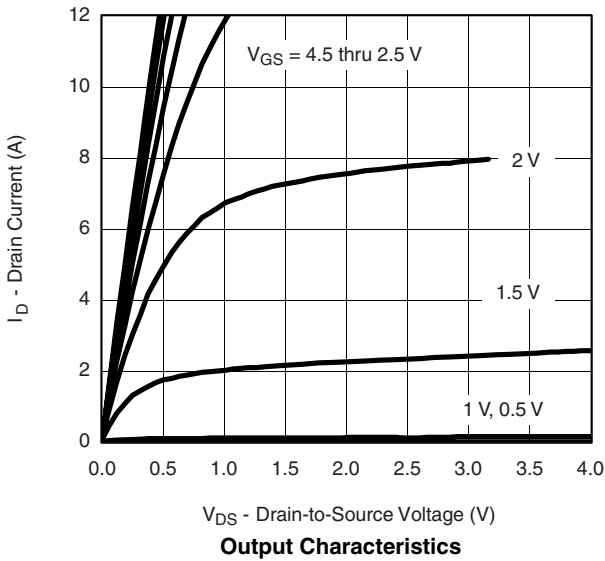

**Output Characteristics**

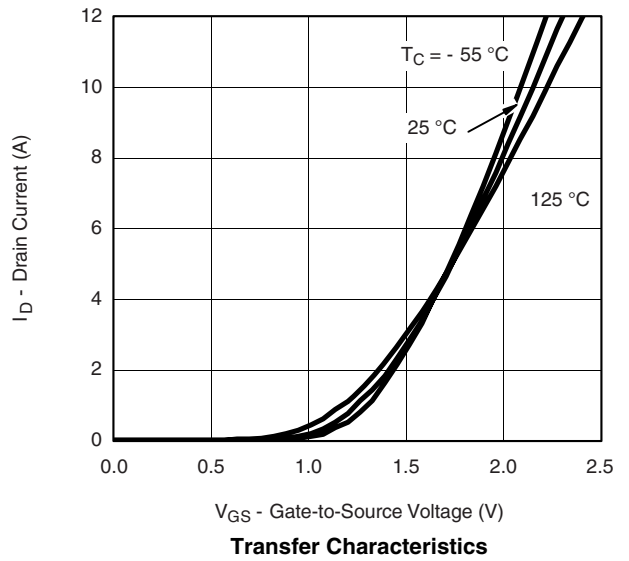

**Transfer Characteristics**

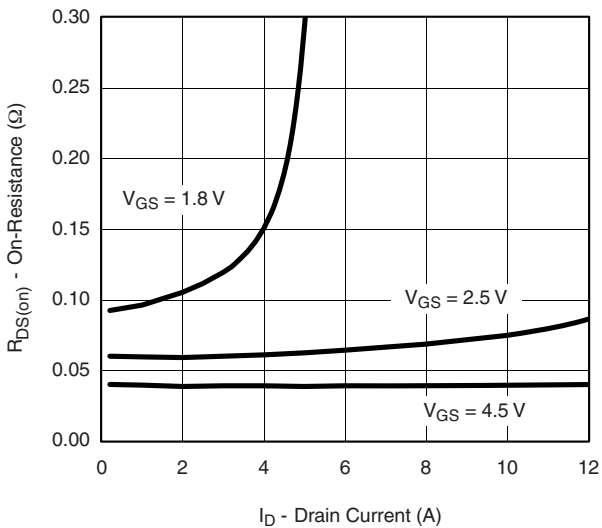

**On-Resistance vs. Drain Current**

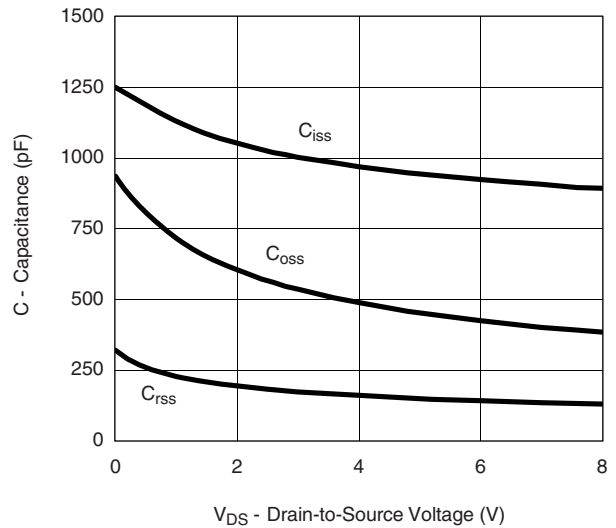

**Capacitance**

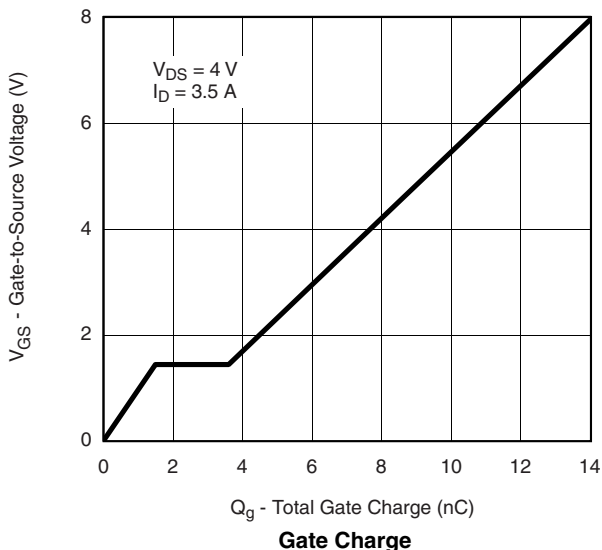

**Gate Charge**

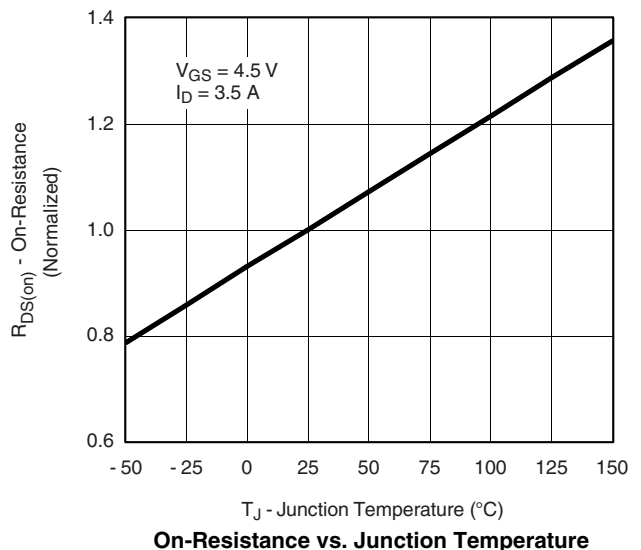

**On-Resistance vs. Junction Temperature**

**LOW VOLTAGE MOSFET (P-CHANNEL)**

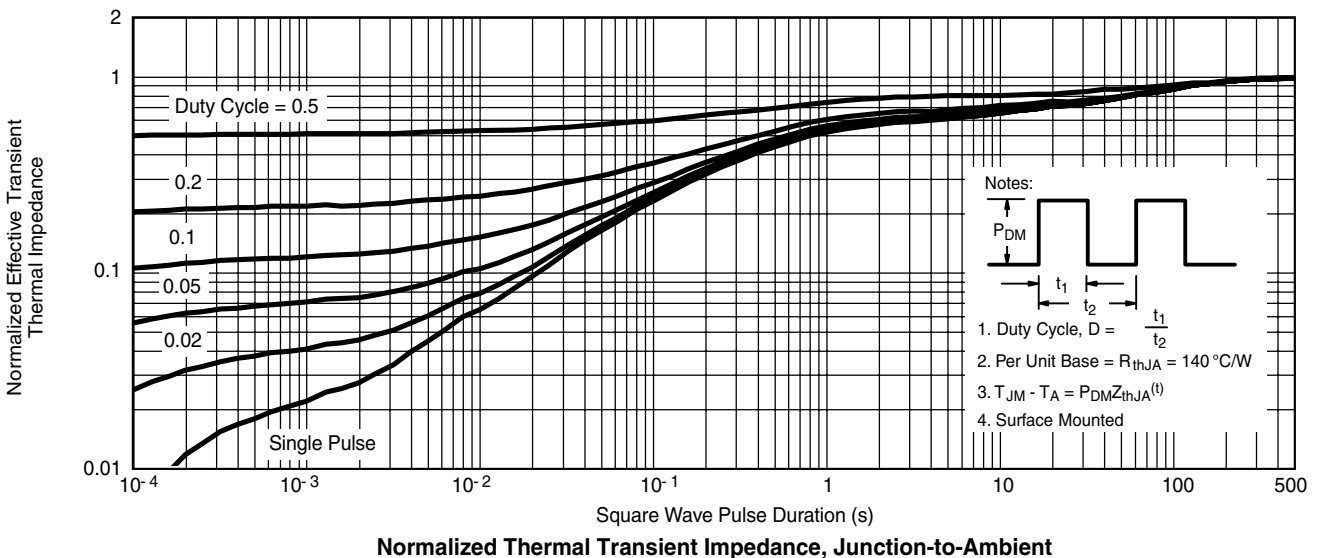
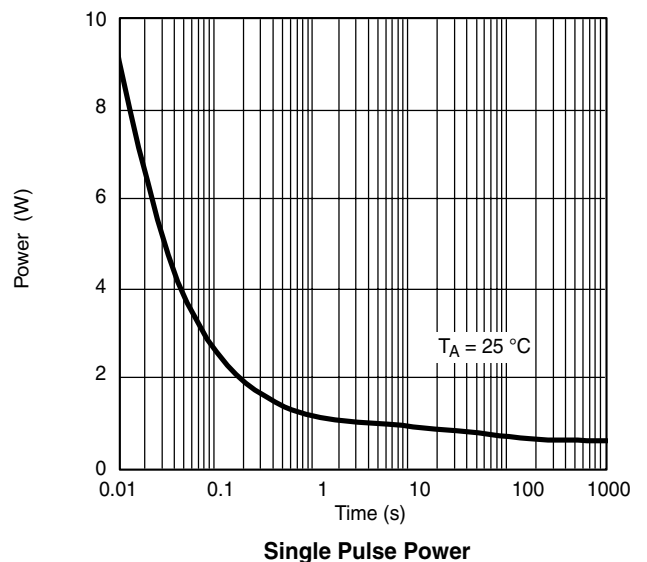
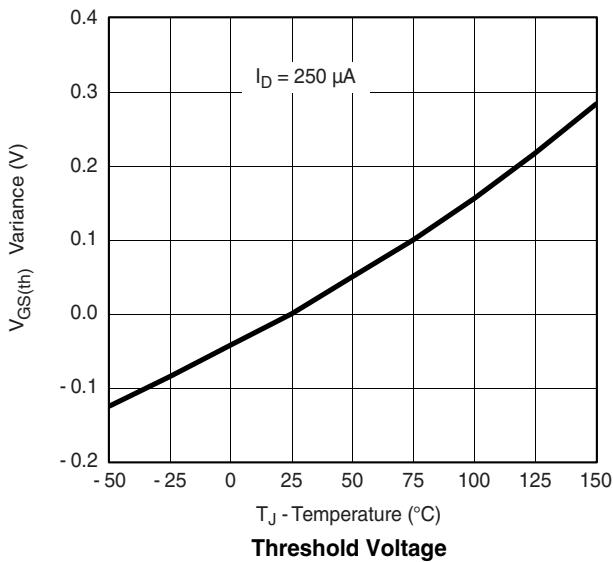
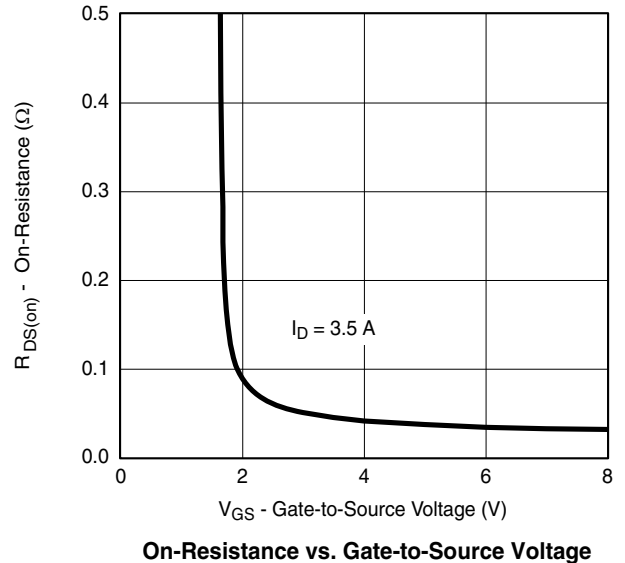
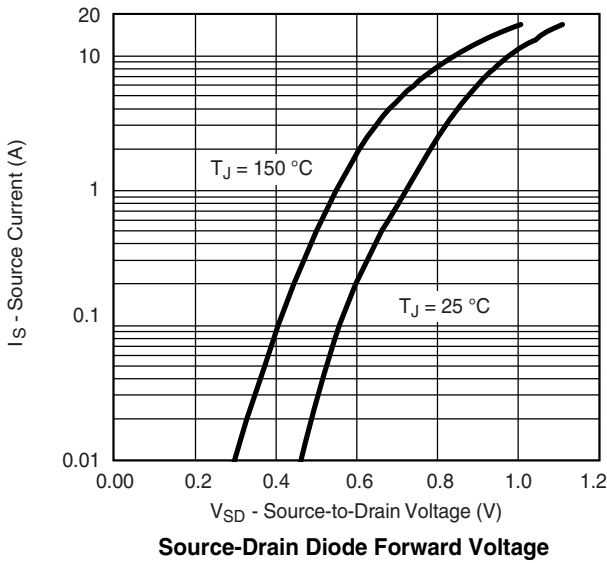

LOW VOLTAGE MOSFET (P-CHANNEL)

**SOT-23 Package Outline Dimensions**

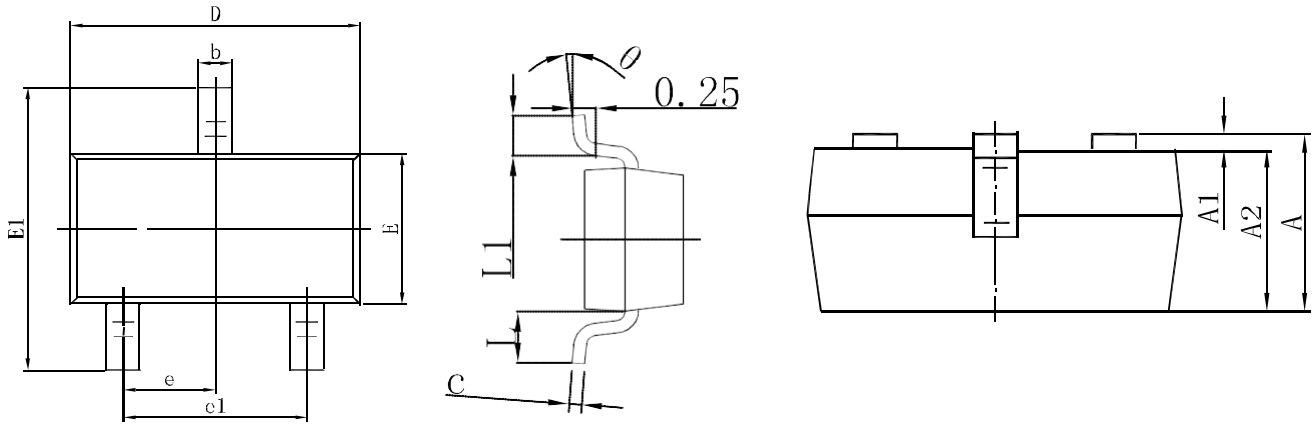

Symbol	Dimensions In Millimeters		Dimensions In Inches	
	Min.	Max.	Min.	Max.
A	0.900	1.150	0.035	0.045
A1	0.000	0.100	0.000	0.004
A2	0.900	1.050	0.035	0.041
b	0.300	0.500	0.012	0.020
c	0.080	0.150	0.003	0.006
D	2.800	3.000	0.110	0.118
E	1.200	1.400	0.047	0.055
E1	2.250	2.550	0.089	0.100
e	0.950 TYP		0.037 TYP	
e1	1.800	2.000	0.071	0.079
L	0.550 REF		0.022 REF	
L1	0.300	0.500	0.012	0.020
θ	0°	8°	0°	8°

**SOT-23 Suggested Pad Layout**

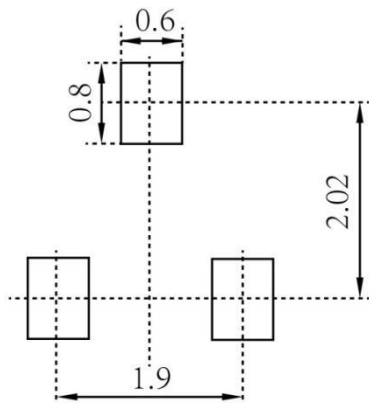

**Note:**

1. Controlling dimension: in millimeters
2. General tolerance: ±0.05mm
3. The pad layout is for reference purposes only

LOW VOLTAGE MOSFET (P-CHANNEL)

**SOT-23 Tape and Reel**

**SOT-23 Embossed Carrier Tape**

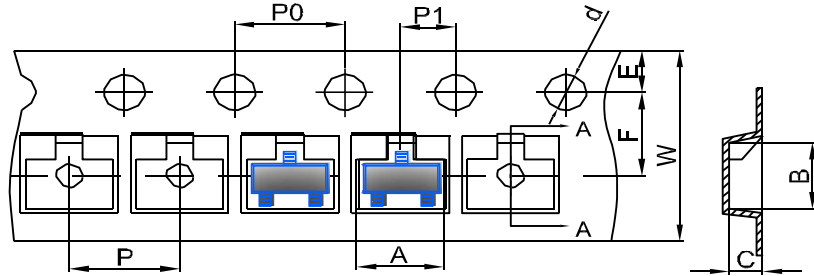

DIMENSIONS ARE IN MILLIMETER										
TYPE	A	B	C	d	E	F	P0	P	P1	W
SOT-23	3.15	2.77	1.22	Ø1.50	1.75	3.50	4.00	4.00	2.00	8.00
TOLERANCE	±0.1	±0.1	±0.1	±0.1	±0.1	±0.1	±0.1	±0.1	±0.1	±0.1

**SOT-23 Tape Leader and Trailer**

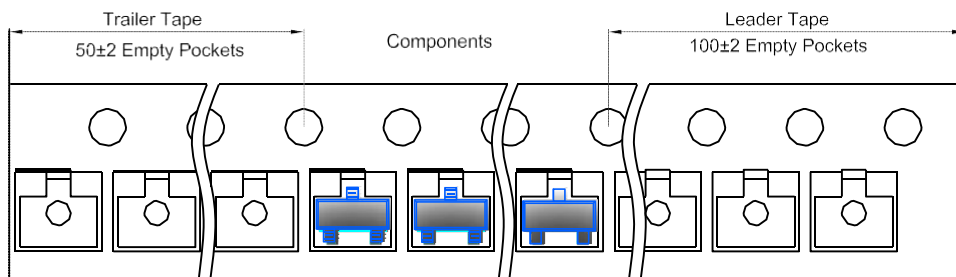

**SOT-23 Reel**

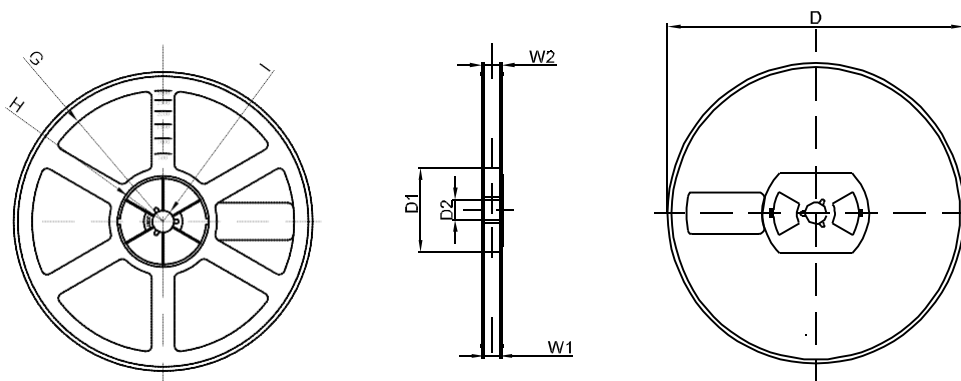

DIMENSIONS ARE IN MILLIMETER								
REEL OPTION	D	D1	D2	G	H	I	W1	W2
7" DIA	Ø178	54.40	13.00	R78	R25.60	R6.50	9.50	12.30
TOLERANCE	±2	±1	±1	±1	±1	±1	±1	±1