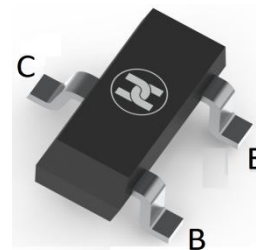
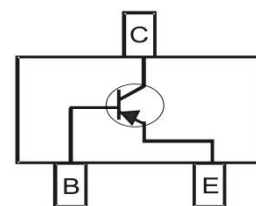

**BIPOLAR TRANSISTOR (PNP)**
**FEATURES**

- High DC current gain : $h_{FE}=200(\text{Typ})$   $V_{CE}=-6\text{V}, I_C=-1\text{mA}$
- High voltage: $V_{CEO}=-50\text{V}$
- Surface Mount device
- Complementary to 2SC1623

**SOT-23**

**MECHANICAL DATA**

- Case: SOT-23
- Case Material: Molded Plastic. UL flammability
- Classification Rating: 94V-0
- Weight: 0.008 grams (approximate)

**MAXIMUM RATINGS ( $T_A = 25^\circ\text{C}$  unless otherwise noted)**

Parameter	Symbol	Value	Unit
Collector-Base Voltage	$V_{CBO}$	-60	V
Collector-Emitter Voltage	$V_{CEO}$	-50	V
Emitter-Base Voltage	$V_{EBO}$	-5	V
Collector Current	$I_C$	-100	mA
Collector Power Dissipation	$P_C$	200	mW
Thermal Resistance From Junction To Ambient	$R_{\theta JA}$	625	$^\circ\text{C}/\text{W}$
Junction Temperature	$T_J$	150	$^\circ\text{C}$
Storage Temperature	$T_{STG}$	-55 ~+150	$^\circ\text{C}$

**ELECTRICAL CHARACTERISTICS ( $T_A = 25^\circ\text{C}$  unless otherwise specified)**

Parameter	Symbol	Min	Typ	Max	Unit	Conditions
Collector-base breakdown voltage	$V_{(BR)CBO}$	-60			V	$I_C=-100\mu\text{A}, I_E=0$
Collector-emitter breakdown voltage	$V_{(BR)CEO}$	-50			V	$I_C=-1\text{mA}, I_B=0$
Emitter-base breakdown voltage	$V_{(BR)EBO}$	-5			V	$I_E=-100\mu\text{A}, I_C=0$
Collector cut-off current	$I_{CBO}$			-0.1	$\mu\text{A}$	$V_{CB}=-60\text{V}, I_E=0$
Emitter cut-off current	$I_{EBO}$			-0.1	$\mu\text{A}$	$V_{EB}=-5\text{V}, I_C=0$
DC current gain	$h_{FE}$	90		600		$V_{CE}=-6\text{V}, I_C=-1\text{mA}$
Collector-emitter saturation voltage	$V_{CE(sat)}$			0.3	V	$I_C=-100\text{mA}, I_B=-10\text{mA}$
Base-emitter saturation voltage	$V_{BE(sat)}$	-0.58		-0.68	V	$I_C=-1\text{mA}, V_{CE}=-6\text{V}$
Transition frequency	$f_T$		180		MHz	$V_{CE}=-6\text{V}, I_C=-10\text{mA}$
Collector output capacitance	$C_{ob}$		4.5		pF	$V_{CB}=-10\text{V}, I_E=0, f=1\text{MHz}$

**CLASSIFICATION OF  $h_{FE}$** 

Rank	M4	M5	M6	M7
Range	90-180	135-270	200-400	300-600
Marking	M4	M5	M6	M7

**BIPOLAR TRANSISTOR (PNP)**

**Typical Characteristics**

**Static Characteristic**

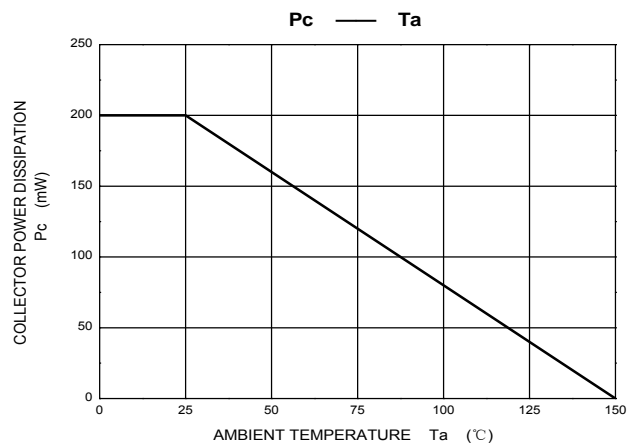
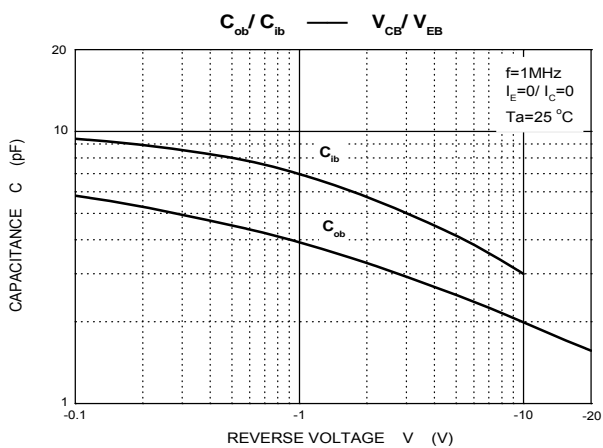
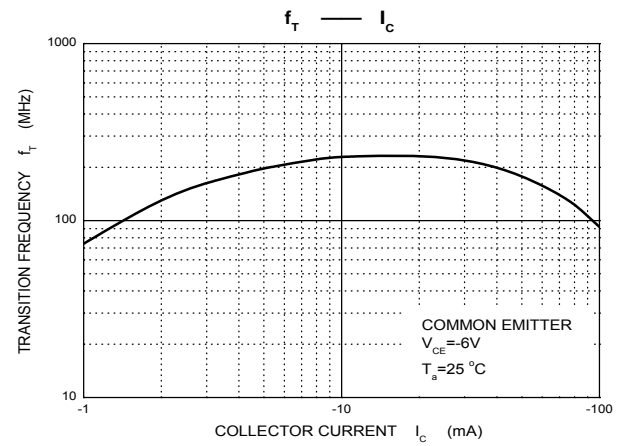
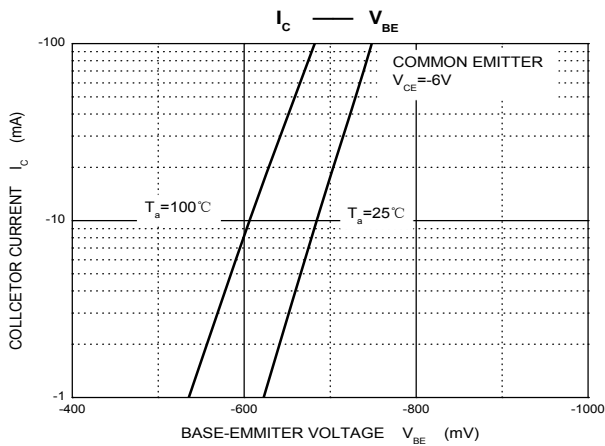
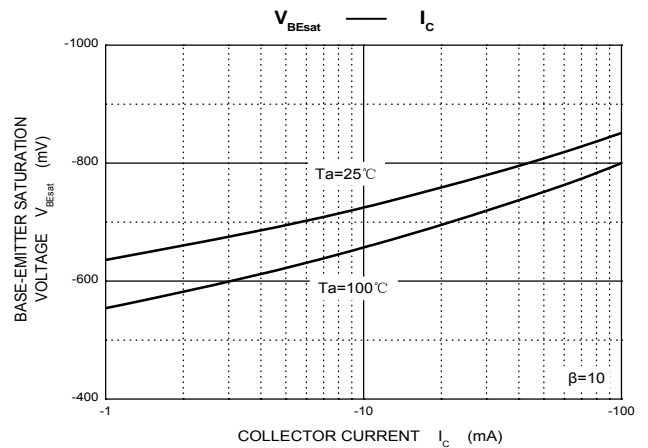
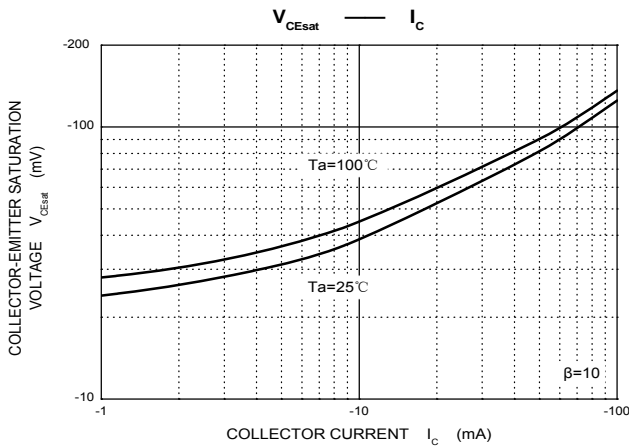
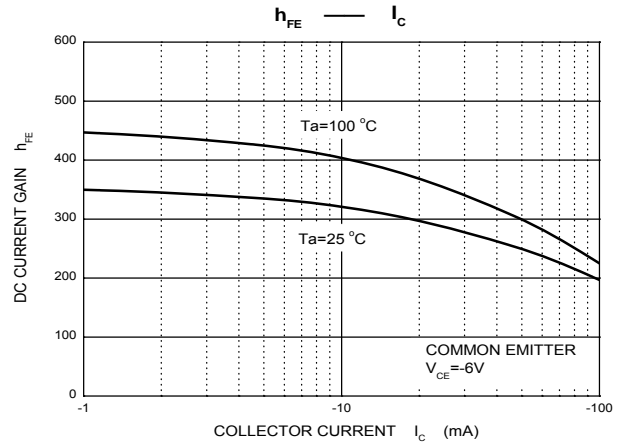
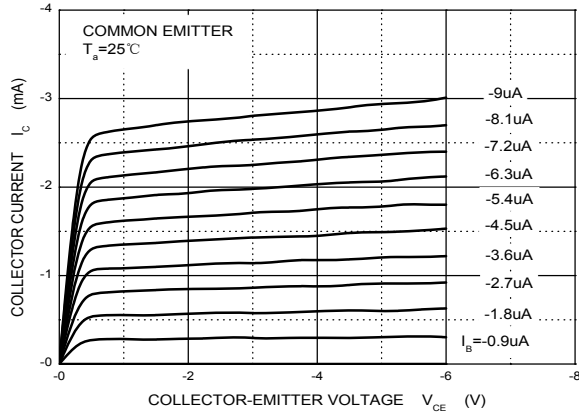

BIPOLAR TRANSISTOR (PNP)

SOT-23 Package Outline Dimensions

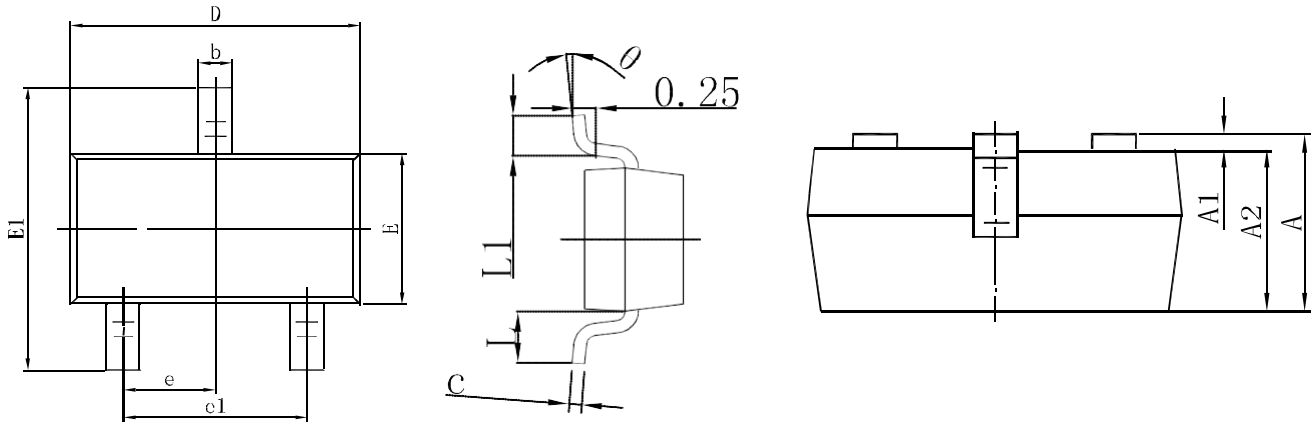

Symbol	Dimensions In Millimeters		Dimensions In Inches	
	Min.	Max.	Min.	Max.
A	0.900	1.150	0.035	0.045
A1	0.000	0.100	0.000	0.004
A2	0.900	1.050	0.035	0.041
b	0.300	0.500	0.012	0.020
c	0.080	0.150	0.003	0.006
D	2.800	3.000	0.110	0.118
E	1.200	1.400	0.047	0.055
E1	2.250	2.550	0.089	0.100
e	0.950 TYP		0.037 TYP	
e1	1.800	2.000	0.071	0.079
L	0.550 REF		0.022 REF	
L1	0.300	0.500	0.012	0.020
θ	0°	8°	0°	8°

SOT-23 Suggested Pad Layout

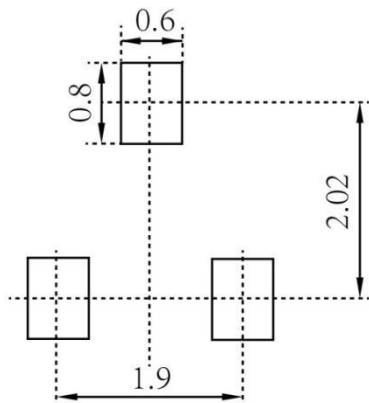

Note:

1. Controlling dimension: in millimeters
2. General tolerance: ±0.05mm
3. The pad layout is for reference purposes only

BIPOLAR TRANSISTOR (PNP)

SOT-23 Tape and Reel

SOT-23 Embossed Carrier Tape

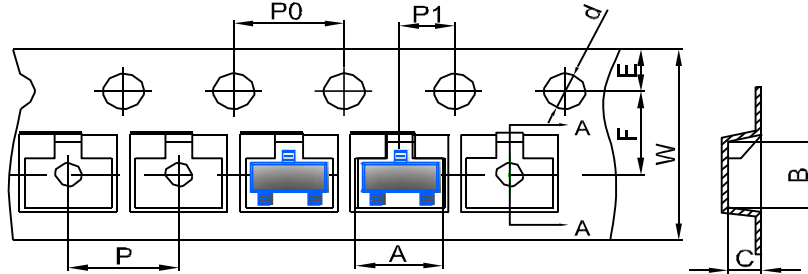

DIMENSIONS ARE IN MILLIMETER										
TYPE	A	B	C	d	E	F	P0	P	P1	W
SOT-23	3.15	2.77	1.22	Ø1.50	1.75	3.50	4.00	4.00	2.00	8.00
TOLERANCE	±0.1	±0.1	±0.1	±0.1	±0.1	±0.1	±0.1	±0.1	±0.1	±0.1

SOT-23 Tape Leader and Trailer

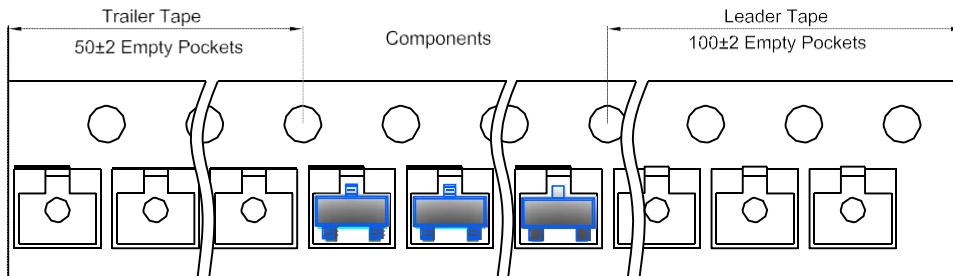

SOT-23 Reel

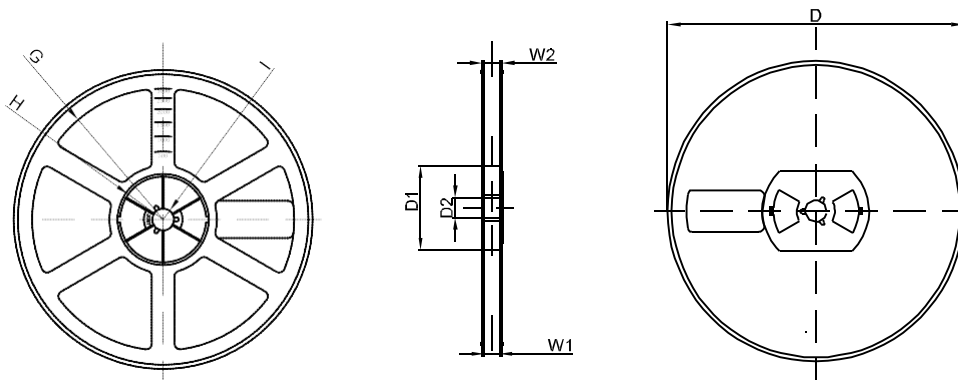

DIMENSIONS ARE IN MILLIMETER								
REEL OPTION	D	D1	D2	G	H	I	W1	W2
7" DIA	Ø178	54.40	13.00	R78	R25.60	R6.50	9.50	12.30
TOLERANCE	±2	±1	±1	±1	±1	±1	±1	±1