

BIPOLAR TRANSISTOR (PNP)
FEATURES

- Complementary to 2SD1766
- Low $V_{CE(sat)}$
- Surface Mount device

MECHANICAL DATA

- Case: SOT-89
- Case Material: Molded Plastic. UL flammability
- Classification Rating: 94V-0
- Weight: 0.055 grams (approximate)

MAXIMUM RATINGS ($T_A = 25^\circ\text{C}$ unless otherwise noted)

| Parameter | Symbol | Value | Unit |
|---|-----------------|-----------|--------------------|
| Collector-Base Voltage | V_{CBO} | -40 | V |
| Collector-Emitter Voltage | V_{CEO} | -32 | V |
| Emitter-Base Voltage | V_{EBO} | -5 | V |
| Collector Current | I_C | -2 | A |
| Collector Power Dissipation | P_C | 500 | mW |
| Thermal Resistance From Junction To Ambient | $R_{\theta JA}$ | 250 | $^\circ\text{C/W}$ |
| Junction Temperature | T_J | 150 | $^\circ\text{C}$ |
| Storage Temperature | T_{STG} | -55 ~+150 | $^\circ\text{C}$ |

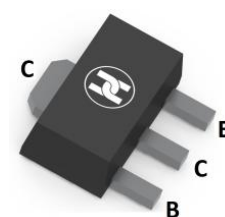
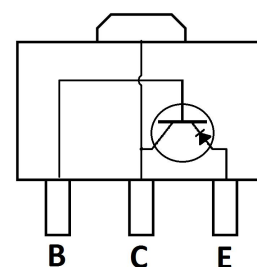
SOT-89

ELECTRICAL CHARACTERISTICS ($T_A = 25^\circ\text{C}$ unless otherwise specified)

| Parameter | Symbol | Min | Typ | Max | Unit | Conditions |
|--------------------------------------|---------------|-----|-----|------|---------------|---|
| Collector-base breakdown voltage | $V_{(BR)CBO}$ | -40 | | | V | $I_C = -50\mu\text{A}$, $I_E = 0$ |
| Collector-emitter breakdown voltage | $V_{(BR)CEO}$ | -32 | | | V | $I_C = -1\text{mA}$, $I_B = 0$ |
| Emitter-base breakdown voltage | $V_{(BR)EBO}$ | -5 | | | V | $I_E = -50\mu\text{A}$, $I_C = 0$ |
| Collector cut-off current | I_{CBO} | | | -1 | μA | $V_{CB} = -20\text{V}$, $I_E = 0$ |
| Emitter cut-off current | I_{EBO} | | | -1 | μA | $V_{EB} = -4\text{V}$, $I_C = 0$ |
| DC current gain | h_{FE} | 82 | | 390 | | $V_{CE} = -3\text{V}$, $I_C = -0.5\text{A}$ |
| Collector-emitter saturation voltage | $V_{CE(sat)}$ | | | -0.8 | V | $I_C = -2\text{A}$, $I_B = -0.2\text{A}$ |
| Transition frequency | f_T | | 100 | | MHz | $V_{CE} = -5\text{V}$, $I_C = -0.5\text{A}$, $f = 30\text{MHz}$ |
| Collector output capacitance | C_{ob} | | 50 | | pF | $V_{CB} = -10\text{V}$, $I_E = 0$, $f = 1\text{MHz}$ |

CLASSIFICATION OF h_{FE}

| Rank | P | Q | R |
|---------|--------|---------|---------|
| Range | 82-180 | 120-270 | 180-390 |
| Marking | BCP | BCQ | BCR |

BIPOLAR TRANSISTOR (PNP)

Typical Characteristics

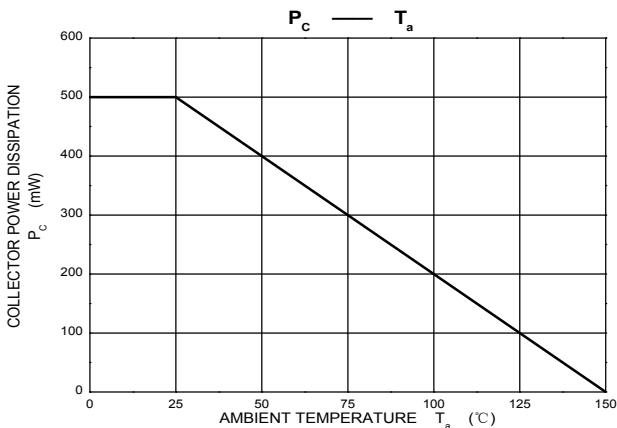
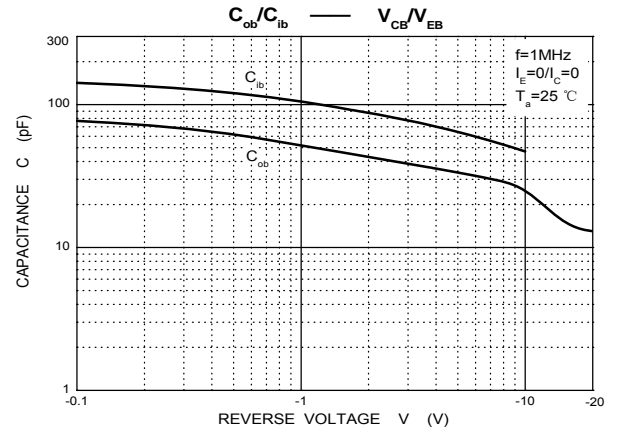
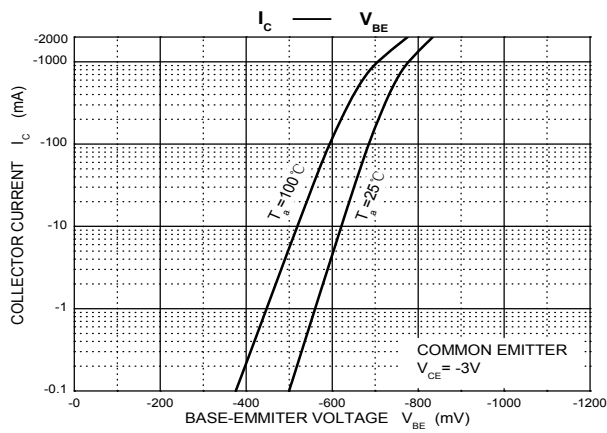
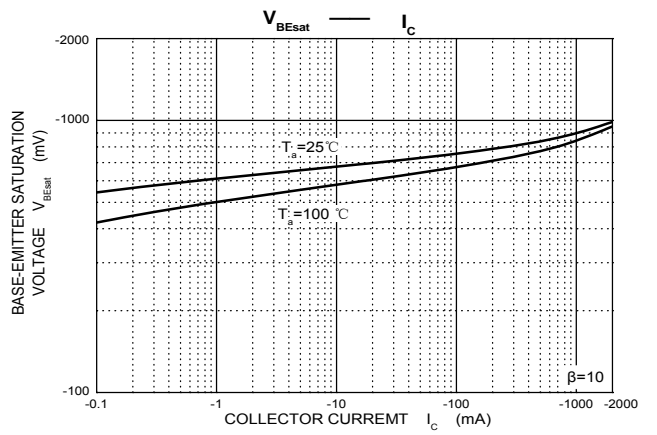
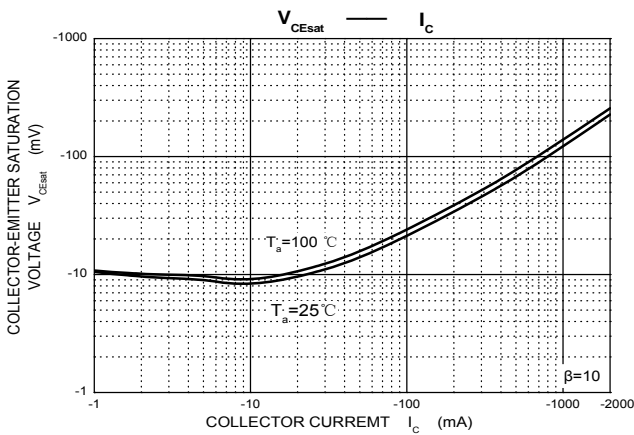
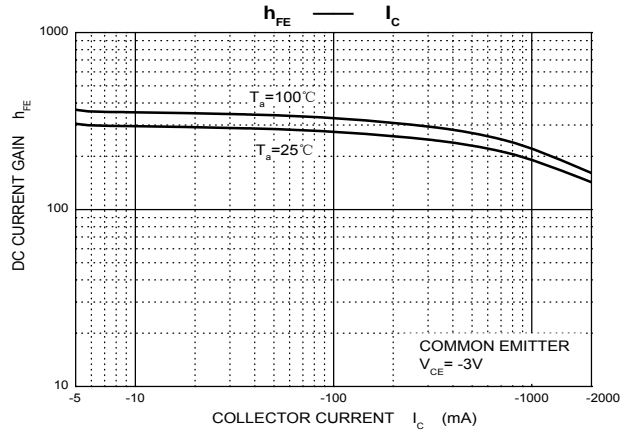
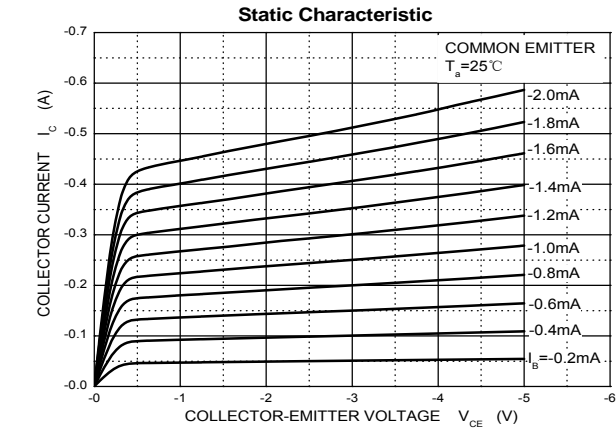

BIPOLAR TRANSISTOR (PNP)

SOT-89 Package Outline Dimensions

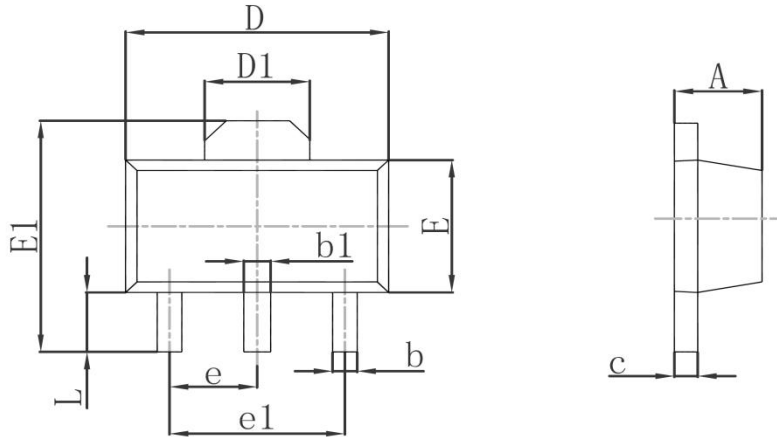

| Symbol | Dimensions In Millimeters | | Dimensions In Inches | |
|--------|---------------------------|-------|----------------------|-------|
| | Min. | Max. | Min. | Max. |
| A | 1.400 | 1.600 | 0.055 | 0.063 |
| b | 0.320 | 0.520 | 0.013 | 0.020 |
| b1 | 0.400 | 0.580 | 0.016 | 0.023 |
| c | 0.350 | 0.440 | 0.014 | 0.017 |
| D | 4.400 | 4.600 | 0.173 | 0.181 |
| D1 | 1.550REF | | 0.061REF | |
| E | 2.300 | 2.600 | 0.091 | 0.102 |
| E1 | 3.940 | 4.250 | 0.155 | 0.167 |
| e | 1.500TYP | | 0.060TYP | |
| e1 | 3.000TYP | | 0.118TYP | |
| L | 0.900 | 1.200 | 0.035 | 0.047 |

SOT-89 Suggested Pad Layout

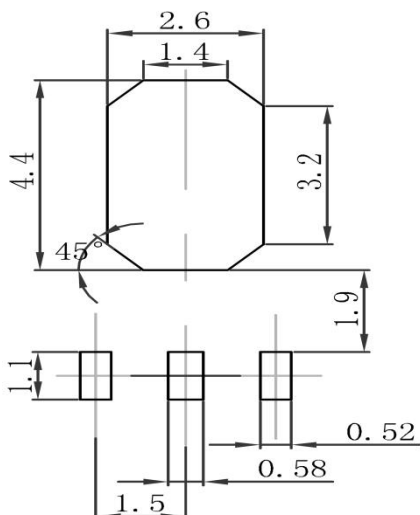

Note:

1. Controlling dimension: in millimeters
2. General tolerance: $\pm 0.05\text{mm}$
3. The pad layout is for reference purposes only

BIPOLAR TRANSISTOR (PNP)

SOT-89 Tape and Reel

SOT-89 Embossed Carrier Tape

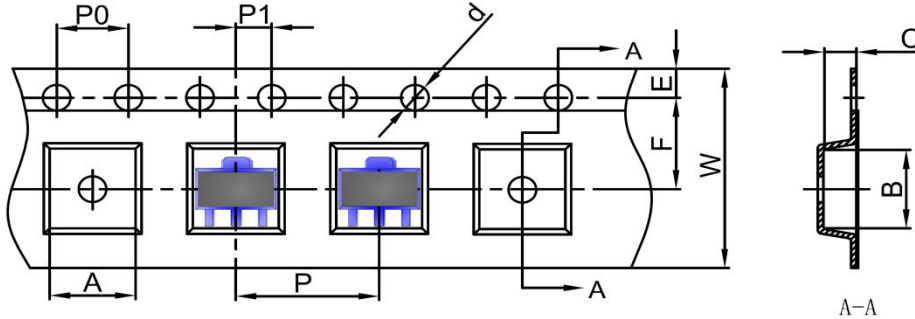

| DIMENSIONS ARE IN MILLIMETER | | | | | | | | | | |
|------------------------------|------|------|------|-------|------|------|------|------|------|-------|
| TYPE | A | B | C | d | E | F | P0 | P | P1 | W |
| SOT-89 | 4.85 | 4.45 | 1.85 | Ø1.50 | 1.75 | 5.50 | 4.00 | 8.00 | 2.00 | 12.00 |
| TOLERANCE | ±0.1 | ±0.1 | ±0.1 | ±0.1 | ±0.1 | ±0.1 | ±0.1 | ±0.1 | ±0.1 | ±0.1 |

SOT-89 Tape Leader and Trailer

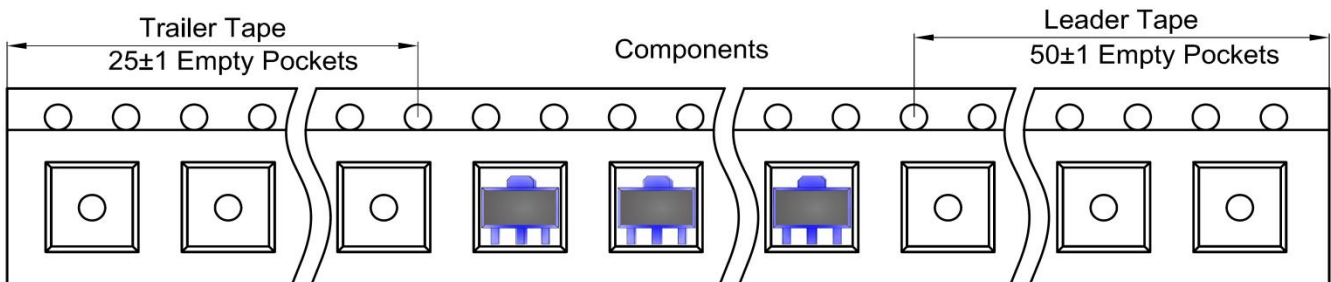

SOT-89 Reel

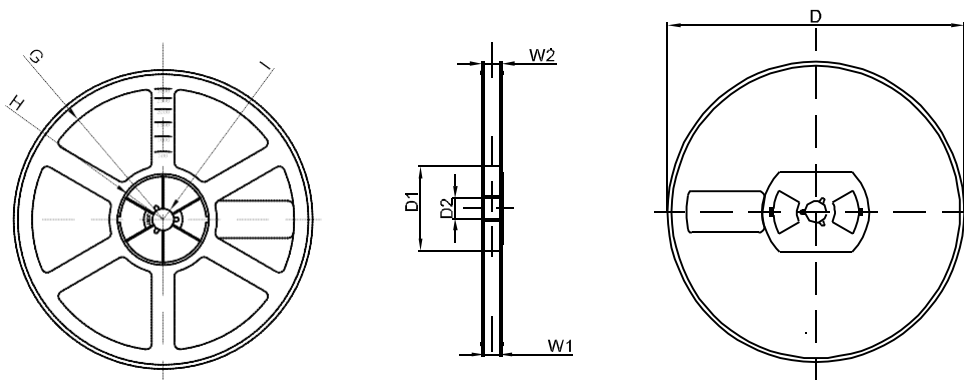

| DIMENSIONS ARE IN MILLIMETER | | | | | | | | |
|------------------------------|------|-------|-------|-----|--------|-------|-------|-------|
| REEL OPTION | D | D1 | D2 | G | H | I | W1 | W2 |
| 7" DIA | Ø178 | 54.40 | 13.00 | R78 | R25.60 | R6.50 | 13.20 | 16.50 |
| TOLERANCE | ±2 | ±1 | ±1 | ±1 | ±1 | ±1 | ±1 | ±1 |