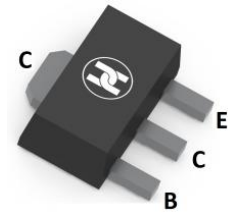
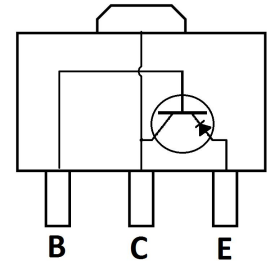

BIPOLAR TRANSISTOR (PNP)
FEATURES

- Complementary to 2SD2150
- Low $V_{CE(sat)}$
- Excellent DC current gain
- Surface Mount device

SOT-89

MECHANICAL DATA

- Case: SOT-89
- Case Material: Molded Plastic. UL flammability
- Classification Rating: 94V-0
- Weight: 0.055 grams (approximate)

MAXIMUM RATINGS ($T_A = 25^\circ\text{C}$ unless otherwise noted)

Parameter	Symbol	Value	Unit
Collector-Base Voltage	V_{CBO}	-20	V
Collector-Emitter Voltage	V_{CEO}	-20	V
Emitter-Base Voltage	V_{EBO}	-6	V
Collector Current	I_C	-3	A
Collector Power Dissipation	P_C	500	mW
Thermal Resistance From Junction To Ambient	$R_{\theta JA}$	250	$^\circ\text{C/W}$
Junction Temperature	T_J	150	$^\circ\text{C}$
Storage Temperature	T_{STG}	-55 ~ +150	$^\circ\text{C}$

ELECTRICAL CHARACTERISTICS ($T_A = 25^\circ\text{C}$ unless otherwise specified)

Parameter	Symbol	Min	Typ	Max	Unit	Conditions
Collector-base breakdown voltage	$V_{(BR)CBO}$	-20			V	$I_C = -50\mu\text{A}$, $I_E = 0$
Collector-emitter breakdown voltage	$V_{(BR)CEO}$	-20			V	$I_C = -1\text{mA}$, $I_B = 0$
Emitter-base breakdown voltage	$V_{(BR)EBO}$	-6			V	$I_E = -50\mu\text{A}$, $I_C = 0$
Collector cut-off current	I_{CBO}			-1	μA	$V_{CB} = -20\text{V}$, $I_E = 0$
Emitter cut-off current	I_{EBO}			-1	μA	$V_{EB} = -5\text{V}$, $I_C = 0$
DC current gain	h_{FE}	120		390		$V_{CE} = -2\text{V}$, $I_C = -0.1\text{A}$
Collector-emitter saturation voltage	$V_{CE(sat)}$			-0.5	V	$I_C = -2\text{A}$, $I_B = -0.1\text{A}$
Transition frequency	f_T		240		MHz	$V_{CE} = -2\text{V}$, $I_C = -0.5\text{A}$, $f = 100\text{MHz}$
Collector output capacitance	C_{ob}		35		pF	$V_{CB} = -10\text{V}$, $I_E = 0$, $f = 1\text{MHz}$

CLASSIFICATION OF h_{FE}

Rank	Q	R
Range	120-270	180-390
Marking	AEQ	AER

BIPOLAR TRANSISTOR (PNP)

Typical Characteristics

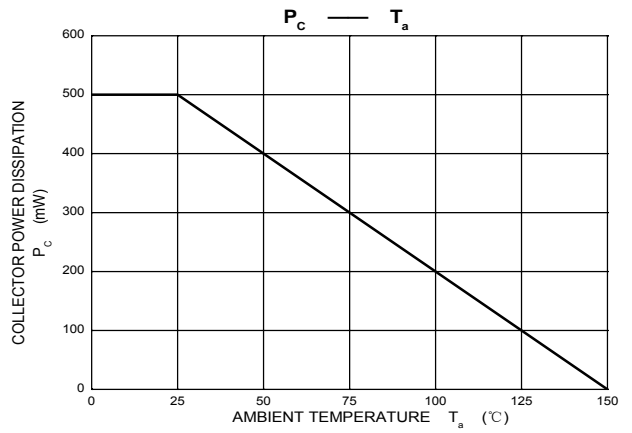
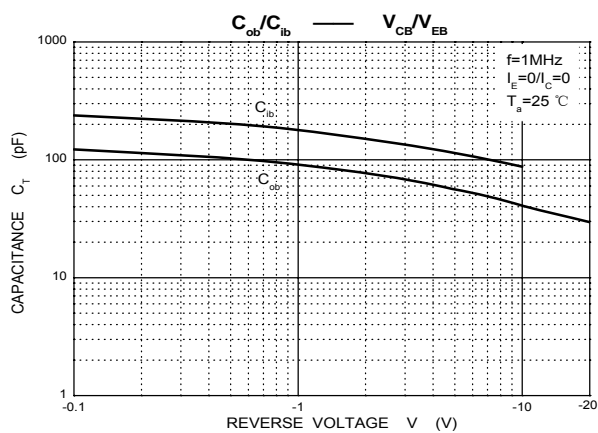
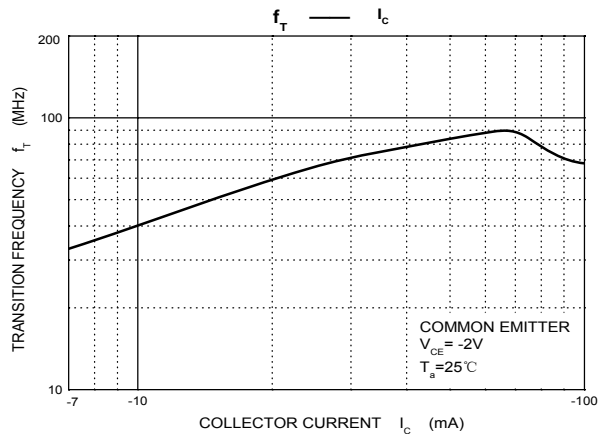
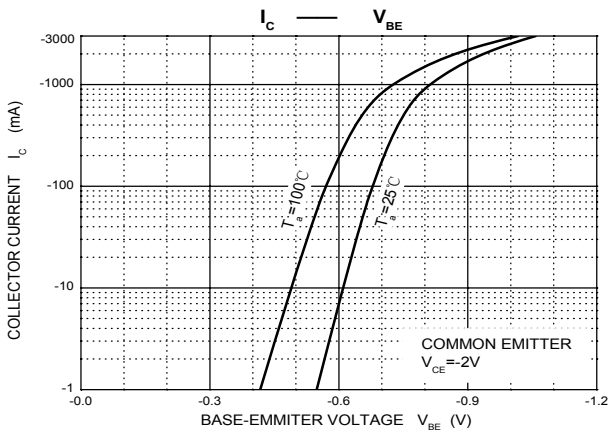
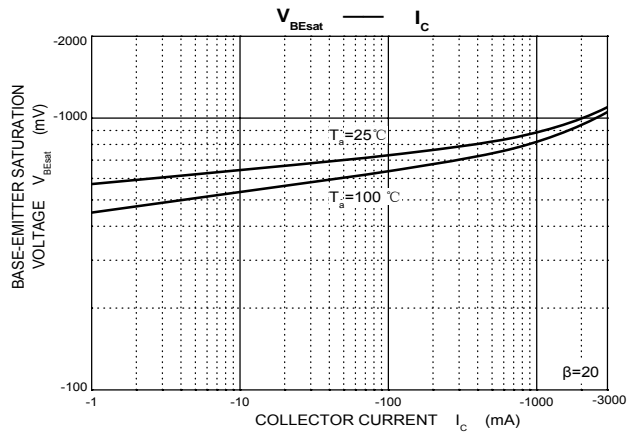
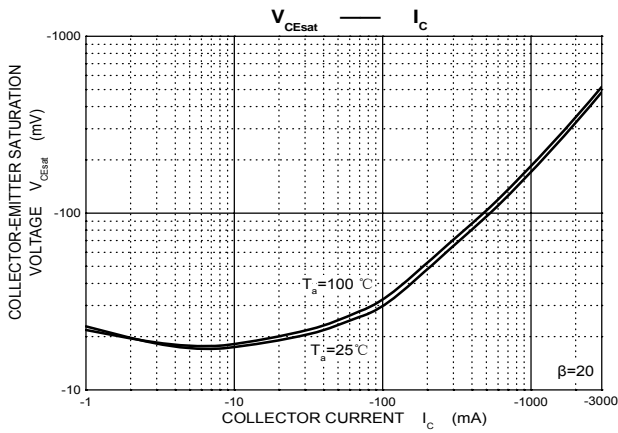
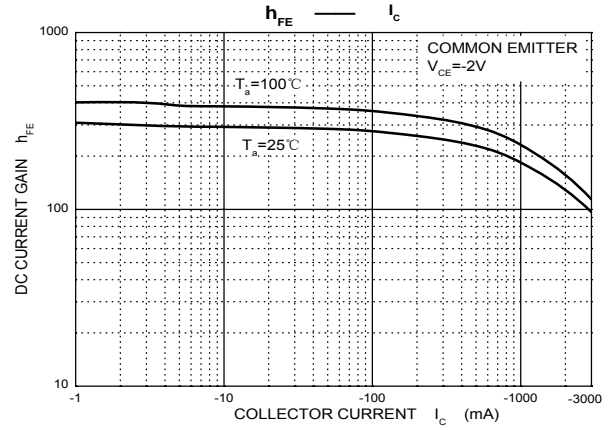
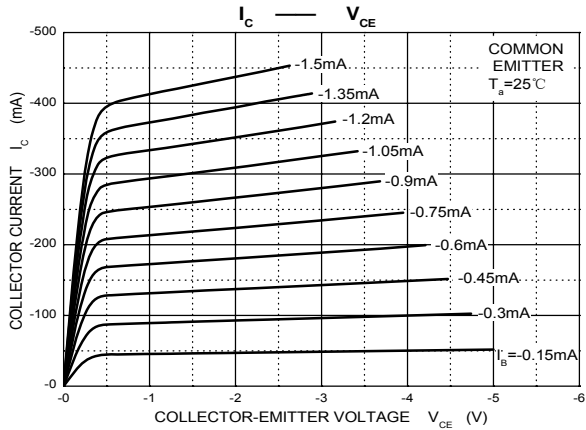

BIPOLAR TRANSISTOR (PNP)

SOT-89 Package Outline Dimensions

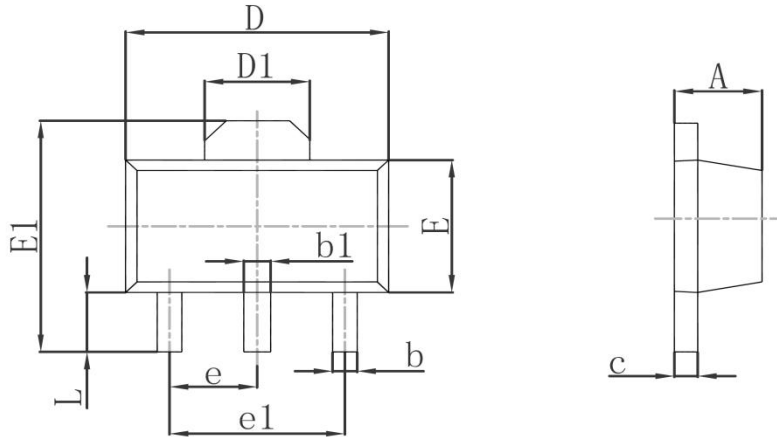

Symbol	Dimensions In Millimeters		Dimensions In Inches	
	Min.	Max.	Min.	Max.
A	1.400	1.600	0.055	0.063
b	0.320	0.520	0.013	0.020
b1	0.400	0.580	0.016	0.023
c	0.350	0.440	0.014	0.017
D	4.400	4.600	0.173	0.181
D1	1.550REF		0.061REF	
E	2.300	2.600	0.091	0.102
E1	3.940	4.250	0.155	0.167
e	1.500TYP		0.060TYP	
e1	3.000TYP		0.118TYP	
L	0.900	1.200	0.035	0.047

SOT-89 Suggested Pad Layout

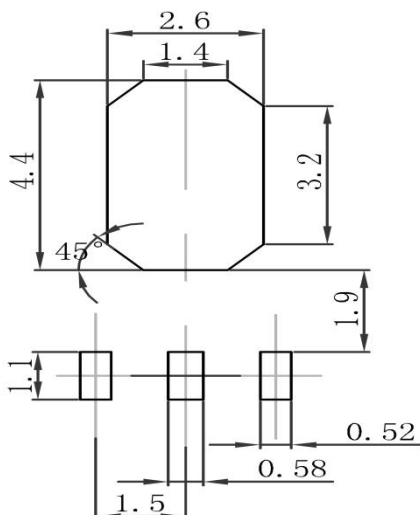

Note:

1. Controlling dimension: in millimeters
2. General tolerance: $\pm 0.05\text{mm}$
3. The pad layout is for reference purposes only

BIPOLAR TRANSISTOR (PNP)

SOT-89 Tape and Reel

SOT-89 Embossed Carrier Tape

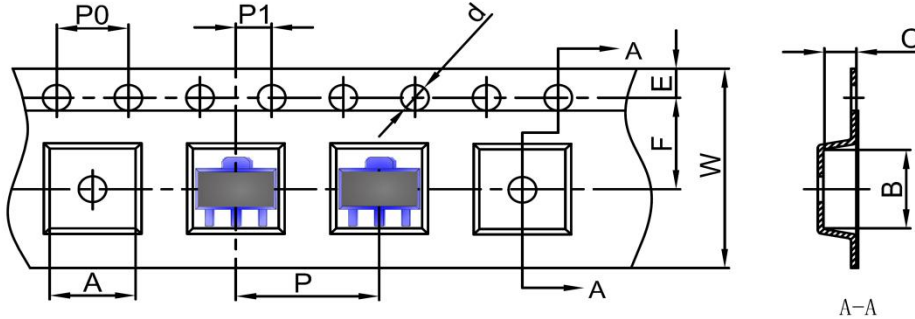

DIMENSIONS ARE IN MILLIMETER										
TYPE	A	B	C	d	E	F	P0	P	P1	W
SOT-89	4.85	4.45	1.85	Ø1.50	1.75	5.50	4.00	8.00	2.00	12.00
TOLERANCE	±0.1	±0.1	±0.1	±0.1	±0.1	±0.1	±0.1	±0.1	±0.1	±0.1

SOT-89 Tape Leader and Trailer

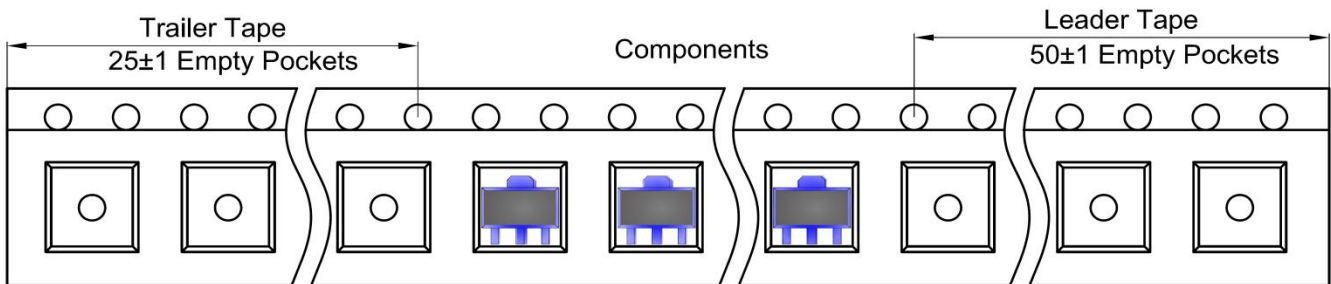

SOT-89 Reel

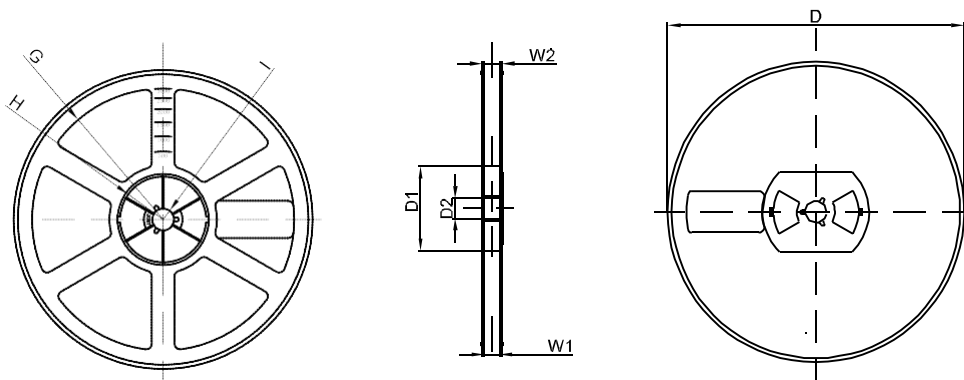

DIMENSIONS ARE IN MILLIMETER								
REEL OPTION	D	D1	D2	G	H	I	W1	W2
7" DIA	Ø178	54.40	13.00	R78	R25.60	R6.50	13.20	16.50
TOLERANCE	±2	±1	±1	±1	±1	±1	±1	±1