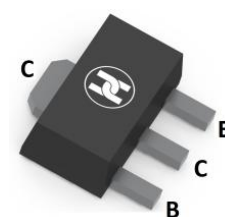
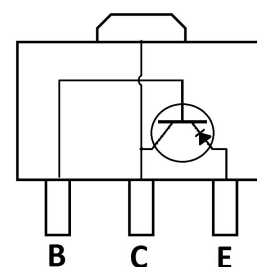

**BIPOLAR TRANSISTOR (PNP)**
**FEATURES**

- Complementary to 2SD2185
- Low Collector-Emitter Saturation Voltage  $V_{CE(sat)}$
- For Low-Frequency Output Amplification
- Surface Mount Device

**MECHANICAL DATA**

- Case: SOT-89
- Case Material: Molded Plastic. UL flammability
- Classification Rating: 94V-0
- Weight: 0.055 grams (approximate)

**SOT-89**

**MAXIMUM RATINGS ( $T_A = 25^\circ\text{C}$  unless otherwise noted)**

Parameter	Symbol	Value	Unit
Collector-Base Voltage	$V_{CBO}$	-50	V
Collector-Emitter Voltage	$V_{CEO}$	-50	V
Emitter-Base Voltage	$V_{EBO}$	-5	V
Collector Current	$I_C$	-2	A
Collector Power Dissipation	$P_C$	500	mW
Junction Temperature	$T_J$	150	$^\circ\text{C}$
Storage Temperature	$T_{STG}$	-55 ~ +150	$^\circ\text{C}$

**ELECTRICAL CHARACTERISTICS ( $T_A = 25^\circ\text{C}$  unless otherwise specified)**

Parameter	Symbol	Min	Typ	Max	Unit	Conditions
Collector-base breakdown voltage	$V_{(BR)CBO}$	-50			V	$I_C = -10\mu\text{A}$ , $I_E = 0$
Collector-emitter breakdown voltage	$V_{(BR)CEO}$	-50			V	$I_C = -1\text{mA}$ , $I_B = 0$
Emitter-base breakdown voltage	$V_{(BR)EBO}$	-5			V	$I_E = -10\mu\text{A}$ , $I_C = 0$
Collector cut-off current	$I_{CBO}$			-1	$\mu\text{A}$	$V_{CB} = -50\text{V}$ , $I_E = 0$
Emitter cut-off current	$I_{EBO}$			-1	$\mu\text{A}$	$V_{EB} = -5\text{V}$ , $I_C = 0$
DC current gain	$h_{FE1}$	120		340		$V_{CE} = -2\text{V}$ , $I_C = -200\text{mA}$
	$h_{FE2}$	60				$V_{CE} = -2\text{V}$ , $I_C = -1\text{A}$
Collector-emitter saturation voltage	$V_{CE(sat)}$			-0.3	V	$I_C = -1\text{A}$ , $I_B = -50\text{mA}$
Base-emitter saturation voltage	$V_{BE(sat)}$			-1.2	V	$I_C = -1\text{A}$ , $I_B = -50\text{mA}$
Transition frequency	$f_T$		80		MHz	$V_{CE} = -10\text{V}$ , $I_C = -50\text{mA}$ , $f = 200\text{MHz}$
Collector output capacitance	$C_{ob}$			60	pF	$V_{CB} = -10\text{V}$ , $I_E = 0$ , $f = 1\text{MHz}$

**CLASSIFICATION OF  $h_{FE}$** 

Rank	R	S
Range	120-240	170-340
Marking	1L	

**BIPOLAR TRANSISTOR (PNP)**

**Typical Characteristics**

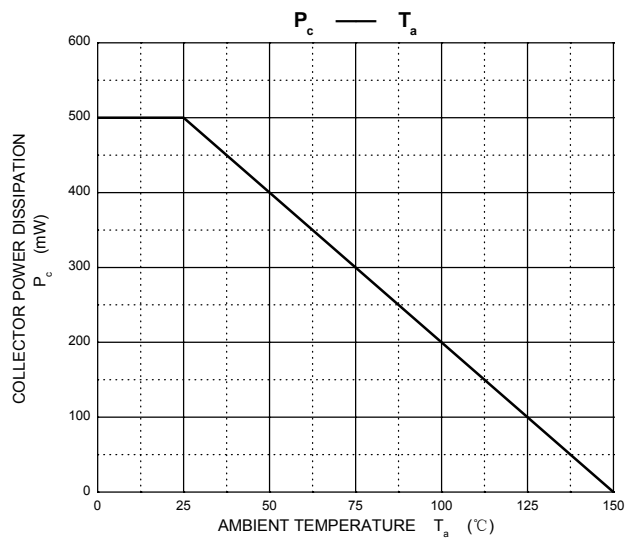
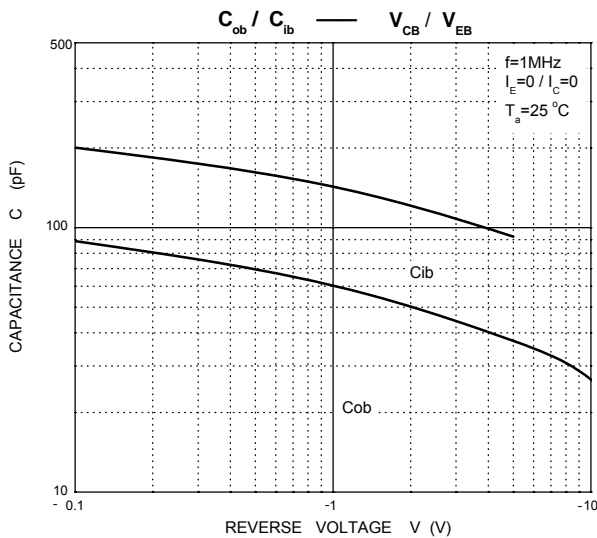
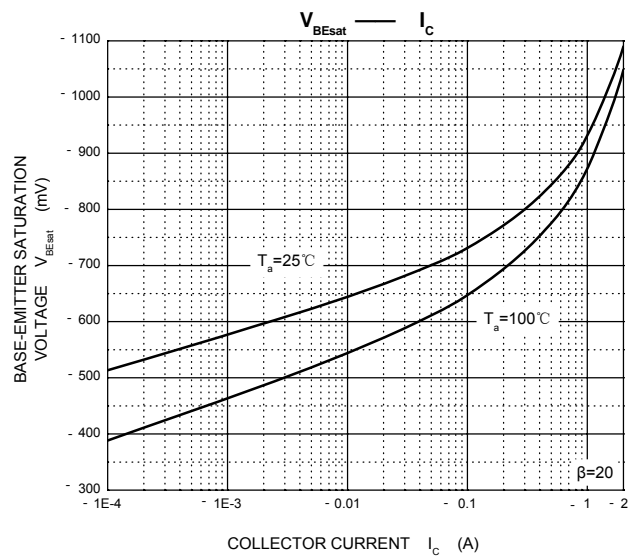
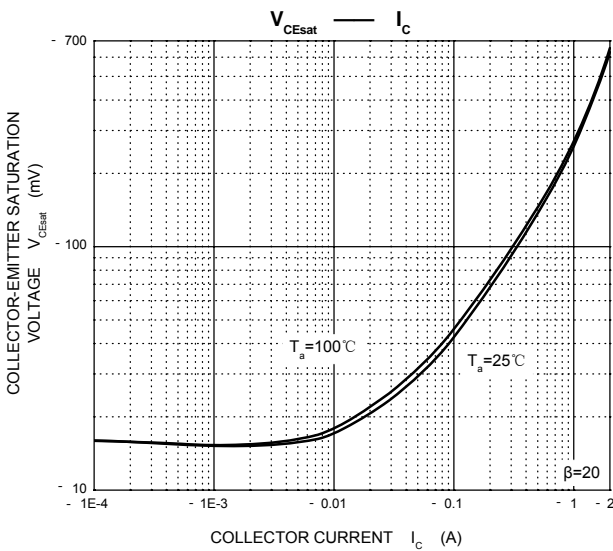
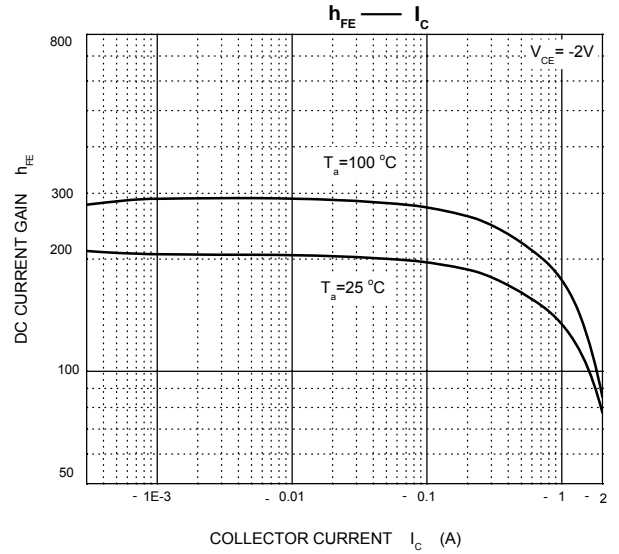
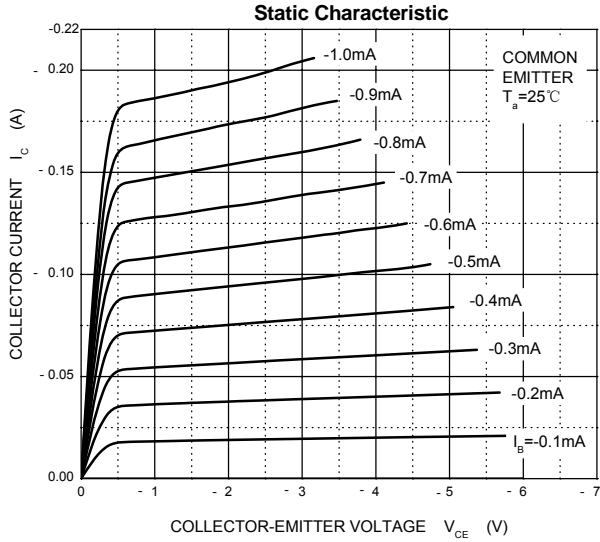

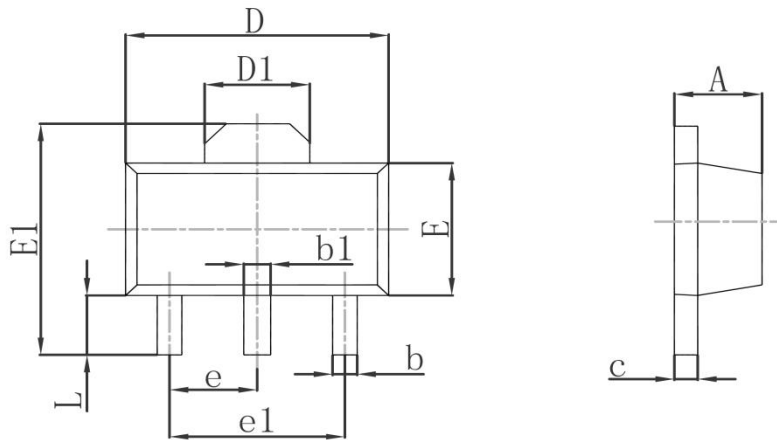
**BIPOLAR TRANSISTOR (PNP)**
**SOT-89 Package Outline Dimensions**

Symbol	Dimensions In Millimeters		Dimensions In Inches	
	Min.	Max.	Min.	Max.
A	1.400	1.600	0.055	0.063
b	0.320	0.520	0.013	0.020
b1	0.400	0.580	0.016	0.023
c	0.350	0.440	0.014	0.017
D	4.400	4.600	0.173	0.181
D1	1.550REF		0.061REF	
E	2.300	2.600	0.091	0.102
E1	3.940	4.250	0.155	0.167
e	1.500TYP		0.060TYP	
e1	3.000TYP		0.118TYP	
L	0.900	1.200	0.035	0.047

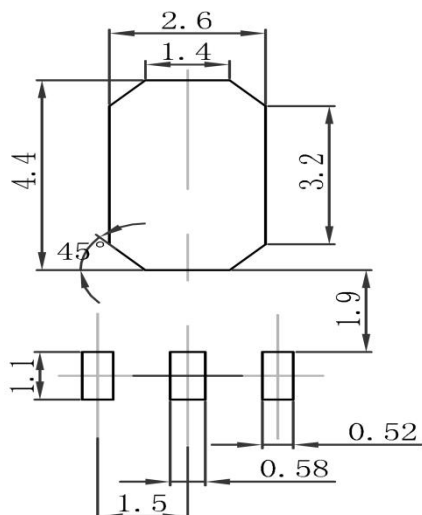
**SOT-89 Suggested Pad Layout**

**Note:**

1. Controlling dimension: in millimeters
2. General tolerance:  $\pm 0.05\text{mm}$
3. The pad layout is for reference purposes only

BIPOLAR TRANSISTOR (PNP)

SOT-89 Tape and Reel

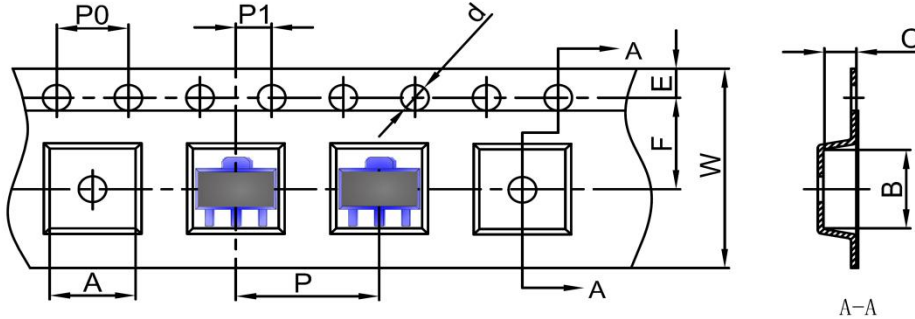
SOT-89 Embossed Carrier Tape



DIMENSIONS ARE IN MILLIMETER										
TYPE	A	B	C	d	E	F	P0	P	P1	W
SOT-89	4.85	4.45	1.85	Ø1.50	1.75	5.50	4.00	8.00	2.00	12.00
TOLERANCE	±0.1	±0.1	±0.1	±0.1	±0.1	±0.1	±0.1	±0.1	±0.1	±0.1

SOT-89 Tape Leader and Trailer

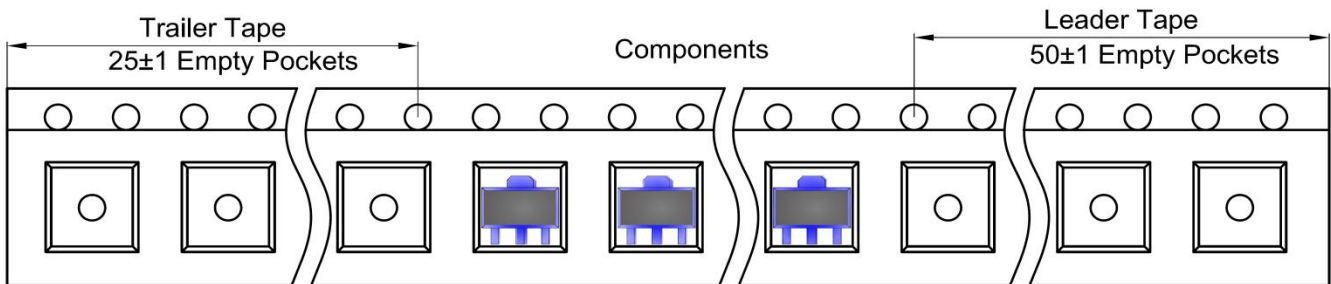

SOT-89 Reel

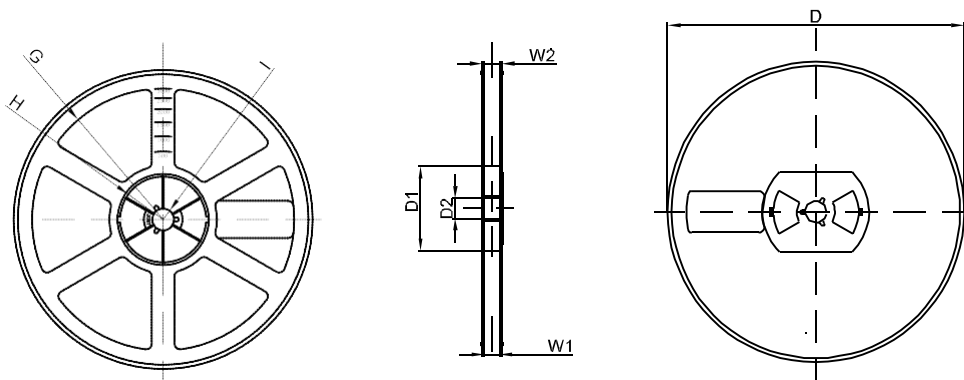

DIMENSIONS ARE IN MILLIMETER								
REEL OPTION	D	D1	D2	G	H	I	W1	W2
7" DIA	Ø178	54.40	13.00	R78	R25.60	R6.50	13.20	16.50
TOLERANCE	±2	±1	±1	±1	±1	±1	±1	±1