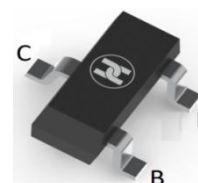
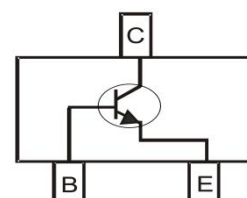

**BIPOLAR TRANSISTOR (NPN)**
**FEATURES**

- High power gain
- Low Noise
- For Low Noise Amplifier at UHF/VHF/CATV Band
- Surface Mount device

**SOT-23**
**MECHANICAL DATA**

- Case: SOT-23
- Case Material: Molded Plastic. UL flammability
- Classification Rating: 94V-0
- Weight: 0.008 grams (approximate)

**MAXIMUM RATINGS (T<sub>A</sub> = 25°C unless otherwise noted)**

Parameter	Symbol	Value	Unit
Collector-Base Voltage	V <sub>CB0</sub>	20	V
Collector-Emitter Voltage	V <sub>CEO</sub>	12	V
Emitter-Base Voltage	V <sub>EBO</sub>	3	V
Collector Current	I <sub>C</sub>	100	mA
Collector Power Dissipation	P <sub>C</sub>	200	mW
Junction Temperature	T <sub>J</sub>	150	°C
Storage Temperature	T <sub>STG</sub>	-55 ~+150	°C

**ELECTRICAL CHARACTERISTICS (T<sub>A</sub> = 25°C unless otherwise specified)**

Parameter	Symbol	Min	Typ	Max	Unit	Conditions
Collector-base breakdown voltage	V <sub>(BR)CBO</sub>	20			V	I <sub>C</sub> =10μA, I <sub>E</sub> =0
Collector-emitter breakdown voltage	V <sub>(BR)CEO</sub>	12			V	I <sub>C</sub> =1mA, I <sub>B</sub> =0
Emitter-base breakdown voltage	V <sub>(BR)EBO</sub>	3			V	I <sub>E</sub> =10μA, I <sub>C</sub> =0
Collector cut-off current	I <sub>CBO</sub>			1	μA	V <sub>CB</sub> =10V, I <sub>E</sub> =0
Emitter cut-off current	I <sub>EBO</sub>			1	μA	V <sub>EB</sub> =1V, I <sub>C</sub> =0
DC current gain	h <sub>FE</sub>	50	120	300		V <sub>CE</sub> =10V, I <sub>C</sub> =20mA
Insertion Power Gain	S <sub>21e</sub>   <sup>2</sup>		11.5		dB	V <sub>CE</sub> =10V, I <sub>C</sub> =20mA, f=1GHz
Transition frequency	f <sub>T</sub>		7		GHz	V <sub>CE</sub> =10V, I <sub>C</sub> =20mA
Collector output capacitance	C <sub>ob</sub>		0.55	1.0	pF	V <sub>CB</sub> =10V, I <sub>E</sub> =0, f=1MHz
Noise figure	NF		1	2	dB	V <sub>CE</sub> =10V, I <sub>C</sub> =7mA, f=1GHz

**CLASSIFICATION OF h<sub>FE</sub>**

Rank	Q	R	S	T
Range	50-100	80-160	125-250	200-330
Marking	R23	R24	R25	R26

**BIPOLAR TRANSISTOR (NPN)**

**Typical Characteristics**

TOTAL POWER DISSIPATION vs. AMBIENT TEMPERATURE

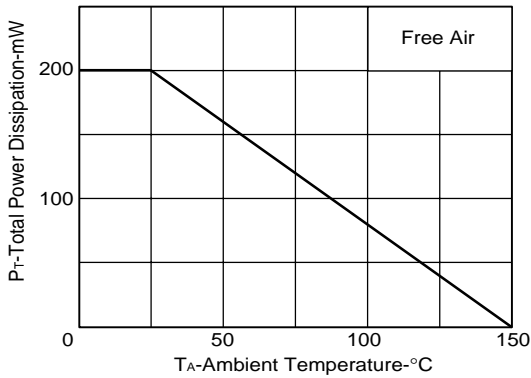

FEED-BACK CAPACITANCE vs. COLLECTOR TO BASE VOLTAGE

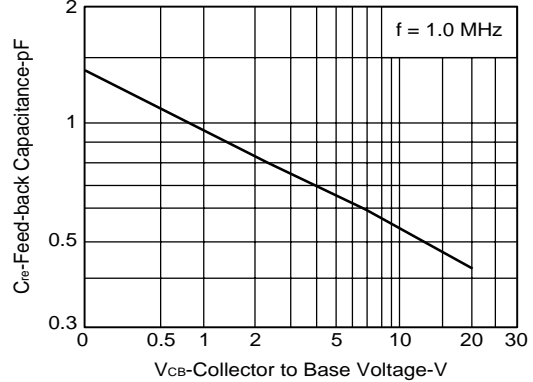

DC CURRENT GAIN vs. COLLECTOR CURRENT

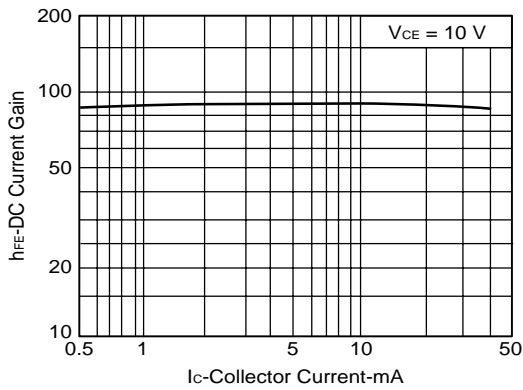

INSERTION GAIN vs. COLLECTOR CURRENT

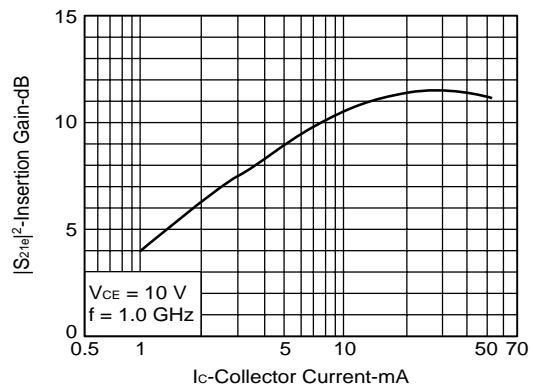

GAIN BANDWIDTH PRODUCT vs. COLLECTOR CURRENT

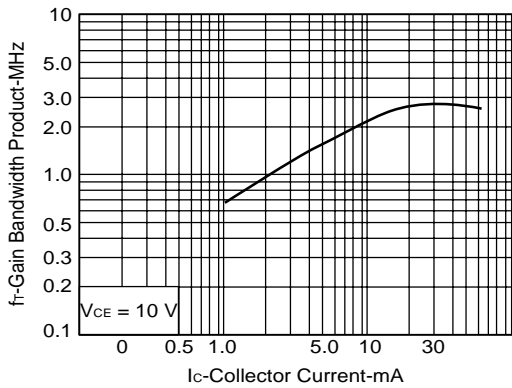

INSERTION GAIN, MAXIMUM GAIN vs. FREQUENCY

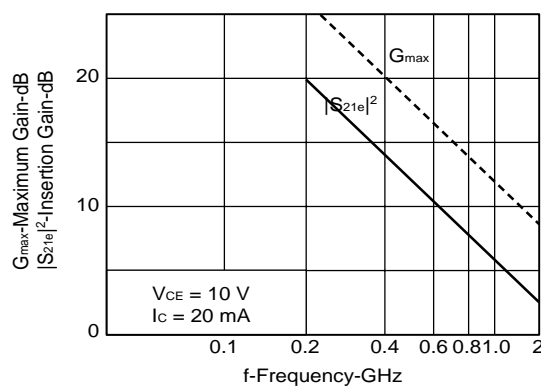

NOISE FIGURE vs. COLLECTOR CURRENT

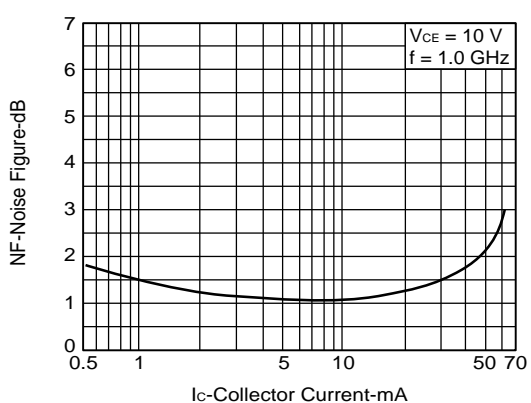

NOISE FIGURE, FORWARD INSERTION GAIN vs. COLLECTOR TO EMITTER VOLTAGE

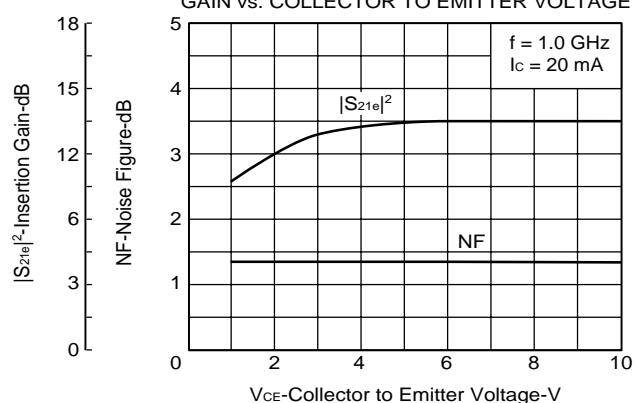

BIPOLAR TRANSISTOR (NPN)

SOT-23 Package Outline Dimensions

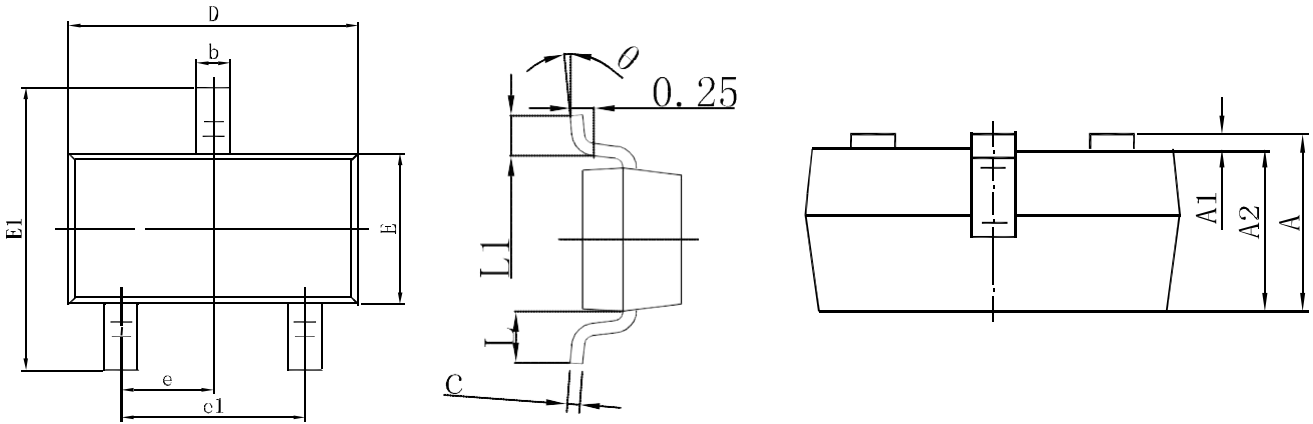

Symbol	Dimensions In Millimeters		Dimensions In Inches	
	Min.	Max.	Min.	Max.
A	0.900	1.150	0.035	0.045
A1	0.000	0.100	0.000	0.004
A2	0.900	1.050	0.035	0.041
b	0.300	0.500	0.012	0.020
c	0.080	0.150	0.003	0.006
D	2.800	3.000	0.110	0.118
E	1.200	1.400	0.047	0.055
E1	2.250	2.550	0.089	0.100
e	0.950 TYP		0.037 TYP	
e1	1.800	2.000	0.071	0.079
L	0.550 REF		0.022 REF	
L1	0.300	0.500	0.012	0.020
θ	0°	8°	0°	8°

SOT-23 Suggested Pad Layout

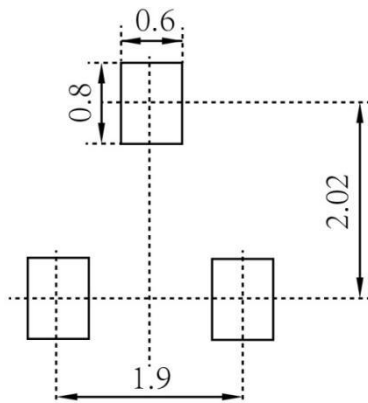

Note:

1. Controlling dimension: in millimeters
2. General tolerance: ±0.05mm
3. The pad layout is for reference purposes only

BIPOLAR TRANSISTOR (NPN)

SOT-23 Tape and Reel

SOT-23 Embossed Carrier Tape

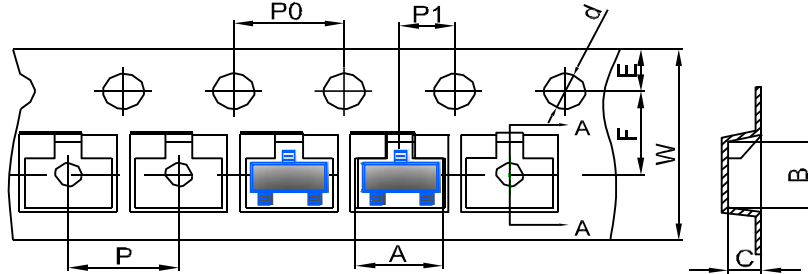

DIMENSIONS ARE IN MILLIMETER										
TYPE	A	B	C	d	E	F	P0	P	P1	W
SOT-23	3.15	2.77	1.22	Ø1.50	1.75	3.50	4.00	4.00	2.00	8.00
TOLERANCE	±0.1	±0.1	±0.1	±0.1	±0.1	±0.1	±0.1	±0.1	±0.1	±0.1

SOT-23 Tape Leader and Trailer

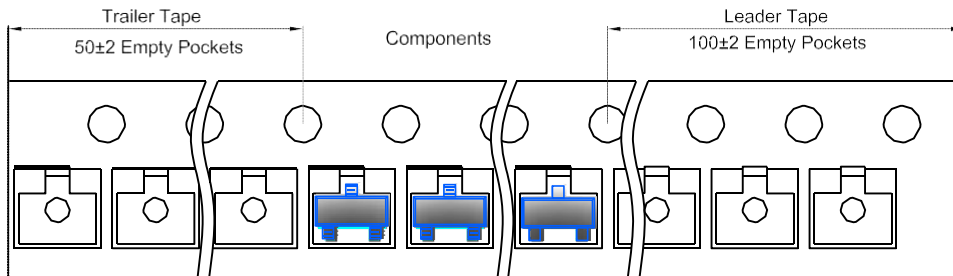

SOT-23 Reel

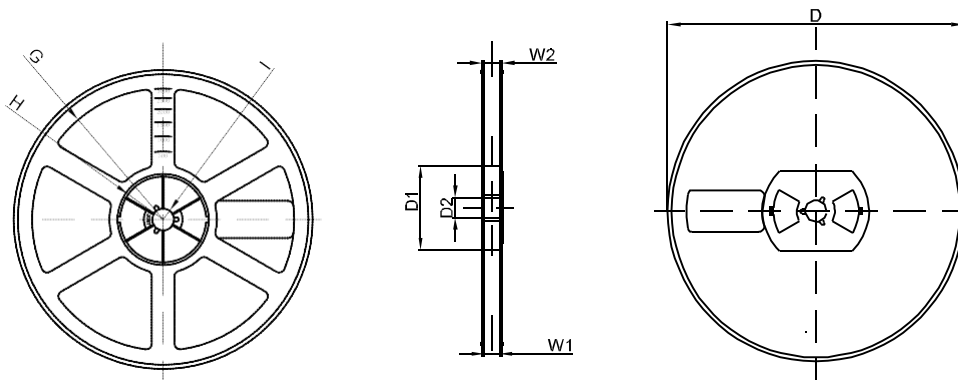

DIMENSIONS ARE IN MILLIMETER								
REEL OPTION	D	D1	D2	G	H	I	W1	W2
7" DIA	Ø178	54.40	13.00	R78	R25.60	R6.50	9.50	12.30
TOLERANCE	±2	±1	±1	±1	±1	±1	±1	±1