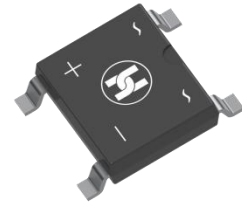
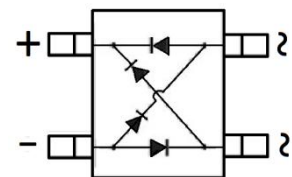

BRIDGE RECTIFIER
FEATURES

- Low Reverse voltage leakage current
- Glass Passivated Die Construction
- Low Forward Voltage Drop
- High forward surge current capability
- Small Surface Mount device

MECHANICAL DATA

- Case: ABS
- Case Material: Molded Plastic. UL flammability
- Classification Rating: 94V-0
- Moisture Sensitivity: Level 1 per J-STD-020
- Weight: 0.10 grams (approximate)

ABS

MAXIMUM RATINGS (T_A = 25°C unless otherwise noted)

Parameter	Symbol	ABS05	ABS1	ABS2	ABS4	ABS6	ABS8	ABS10	Unit
Repetitive peak reverse voltage	V _{RRM}	50	100	200	400	600	800	1000	V
DC Reverse Voltage	V _R	50	100	200	400	600	800	1000	V
RMS Reverse Voltage	V _{RMS}	35	70	140	280	420	560	700	V
Mean rectifying current(Note1)	I _F	1.0							A
Non-Repetitive Peak Forward Surge Current @ t = 8.3 ms	I _{FSM}	35							A
Thermal Resistance From Junction To Ambient	R _{θJA}	80							°C/W
Junction Temperature	T _J	-55 ~+150							°C
Storage Temperature	T _{STG}	-55 ~+150							°C

ELECTRICAL CHARACTERISTICS (T_A = 25°C unless otherwise specified)

Parameter	Symbol	Min	Max	Unit	Conditions
Forward voltage	V _F		1.0	V	I _F =0.5A
Forward voltage	V _F		1.1	V	I _F =1.0A
Reverse current T=25°C	I _R		5	uA	V _R =1000V
Reverse current T=125°C	I _R		100	uA	V _R =1000V
Junction capacitance	C _J		10	pF	V=4V _{DC} ,f=1MH

BRIDGE RECTIFIER

Typical Characteristics

Fig.1 Average Rectified Output Current Derating Curve

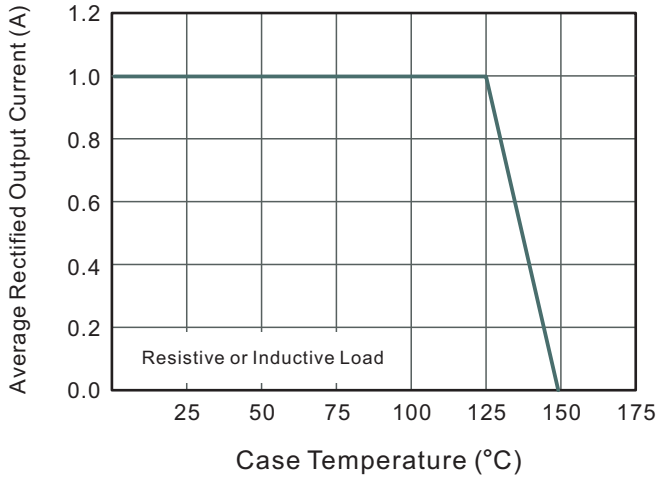

Fig.2 Typical Reverse Characteristics

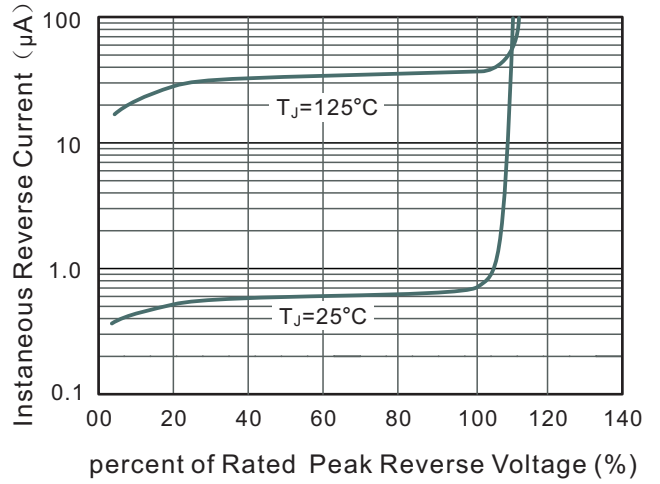

Fig.3 Typical Instantaneous Forward Characteristics

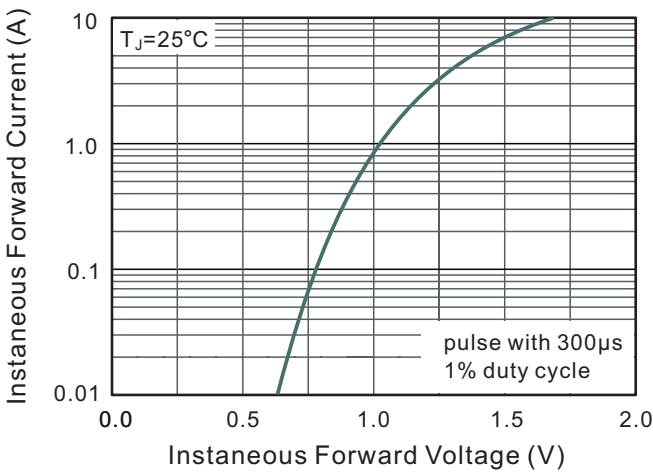

Fig.4 Typical Junction Capacitance

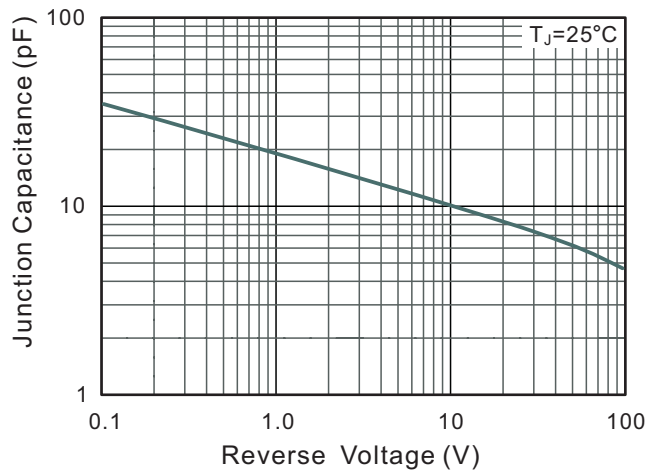
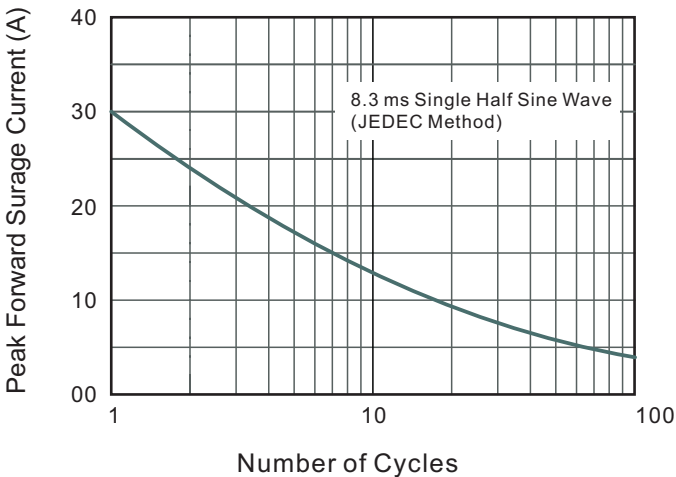
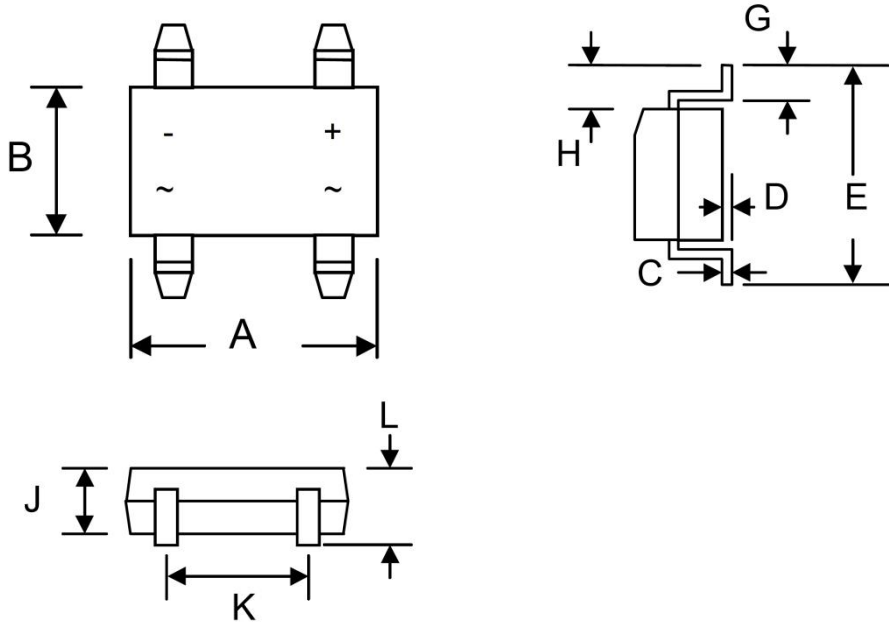
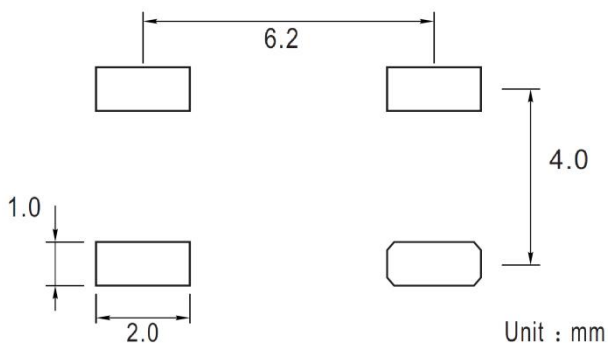

Fig.5 Maximum Non-Repetitive Peak Forward Surge Current



BRIDGE RECTIFIER
ABS Package Outline Dimensions

Symbol	Dimensions In Millimeters		Dimensions In Inches	
	Min.	Max.	Min.	Max.
A	4.80	5.30	0.189	0.209
B	4.20	4.60	0.165	0.181
C	0.15	0.25	0.006	0.010
D	-----	0.20	—	0.008
E	6.00	6.80	0.236	0.268
G	0.30	0.70	0.012	0.028
H	0.90	1.10	0.035	0.043
J	—	1.50	—	0.059
K	3.80	4.20	0.150	0.165
L	1.22	1.72	0.048	0.068

ABS Suggested Pad Layout

Note:

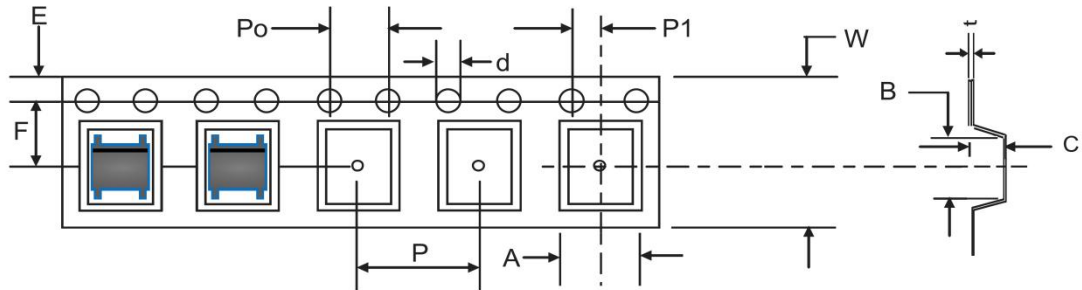
1. Controlling dimension: in millimeters
2. General tolerance: $\pm 0.05\text{mm}$
3. The pad layout is for reference purposes only

BRIDGE RECTIFIER
ABS Tape and Reel
ABS Embossed Carrier Tape

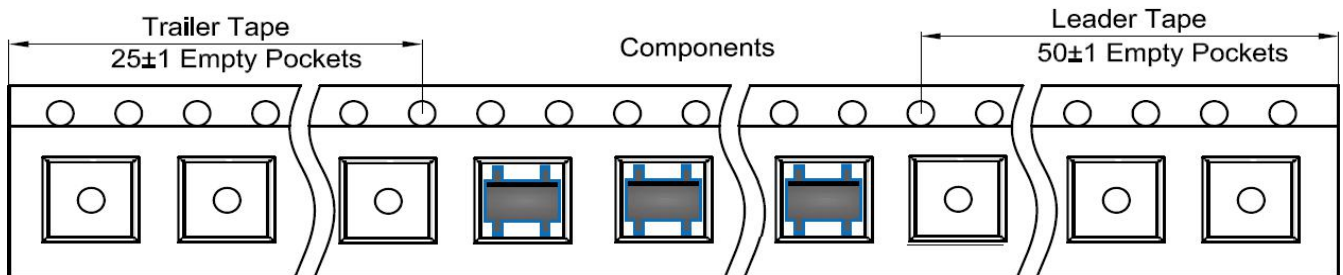
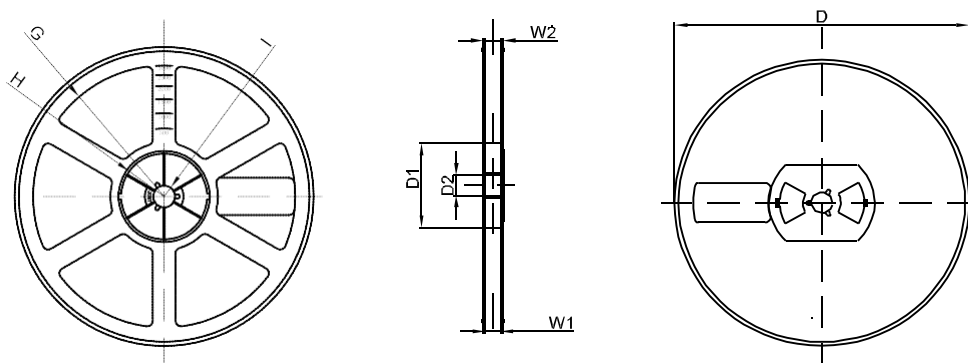
DIMENSIONS ARE IN MILLIMETER										
TYPE	A	B	C	d	E	F	P ₀	P	P ₁	W
ABS	5.31	6.68	1.85	Ø1.50	1.75	5.50	4.00	8.00	2.00	12.00
TOLERANCE	±0.1	±0.1	±0.1	±0.1	±0.1	±0.1	±0.1	±0.1	±0.1	±0.1

ABS Tape Leader and Trailer

ABS Reel

DIMENSIONS ARE IN MILLIMETER								
REEL OPTION	D	D ₁	D ₂	G	H	I	W ₁	W ₂
13" DIA	Ø330	75.0	13.00	R165	R37.50	R6.50	12.40	17.60
TOLERANCE	±2	±1	±1	±1	±1	±1	±1	±1