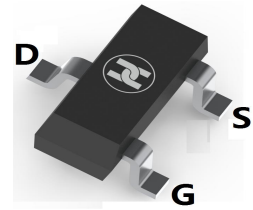
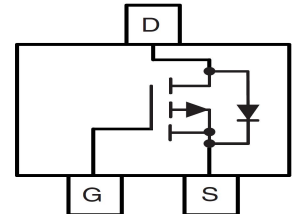


**LOW VOLTAGE MOSFET (P-CHANNEL)**
**FEATURES**

- $V_{DS}=-30V, R_{DS(ON)} \leq 52m\Omega @ V_{GS}=-10V, I_D=-4.1A$
- Low on-resistance
- For PWM and Load switch applications
- Surface Mount device


**SOT-23**

**MECHANICAL DATA**

- Case: SOT-23
- Case Material: Molded Plastic. UL flammability
- Classification Rating: 94V-0
- Weight: 0.008 grams (approximate)

**MAXIMUM RATINGS ( $T_A = 25^\circ\text{C}$  unless otherwise noted)**

Parameter	Symbol	Value	Unit
Drain-source voltage	$V_{DS}$	-30	V
Gate-source voltage	$V_{GS}$	$\pm 20$	V
Continuous drain current	$I_D$	$T_A=25^\circ\text{C}$	-4.1
		$T_A=70^\circ\text{C}$	-3.5
Pulsed drain current	$I_{DM}$	-25	A
Power dissipation	$P_D$	$T_A=25^\circ\text{C}$	1.4
		$T_A=70^\circ\text{C}$	0.9
Thermal resistance from Junction to ambient	$R_{\theta JA}$	125	$^\circ\text{C/W}$
Junction temperature	$T_J$	150	$^\circ\text{C}$
Storage temperature	$T_{STG}$	-55~+150	$^\circ\text{C}$

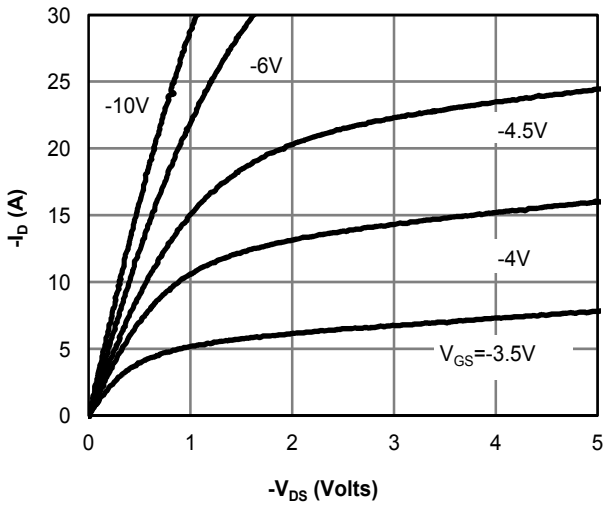
**ELECTRICAL CHARACTERISTICS ( $T_A = 25^\circ\text{C}$  unless otherwise specified)**

Parameter	Symbol	Min	Typ	Max	Unit	Conditions
Drain-Source breakdown voltage	$V_{(BR)DSS}^*$	-30			V	$V_{GS}=0V, I_D=-250\mu A$
Zero gate voltage drain current	$I_{DSS}^*$			-1	$\mu A$	$V_{DS}=-30V, V_{GS}=0V$
Gate-body leakage current	$I_{GSS}^*$			$\pm 100$	nA	$V_{DS}=0V, V_{GS}=\pm 20V$
Gate-threshold voltage	$V_{GS(th)}^*$	-1.4	-1.9	-2.4	V	$V_{DS}=V_{GS}, I_D=-250\mu A$
On state drain current	$I_{D(ON)}^*$	-25			A	$V_{GS}=-10V, V_{DS}=-5V$
Drain-source on-resistance	$R_{DS(ON)}^*$		34	55	m $\Omega$	$V_{GS}=-10V, I_D=-4.1A$
			52	73	m $\Omega$	$V_{GS}=-10V, I_D=-4.1A, T_J=125^\circ\text{C}$
			54	87	m $\Omega$	$V_{GS}=-4.5V, I_D=-3A$
Forward transconductance	$g_{FS}$		5		S	$V_{DS}=-5V, I_D=-4.1A$
Gate resistance	$R_g$	3.5	7.5	11.5	$\Omega$	$V_{DS}=0V, V_{GS}=0V, f=1\text{MHz}$
Input capacitance	$C_{iss}$		520		pF	$V_{DS}=-15V, V_{GS}=0V, f=1\text{MHz}$
Output capacitance	$C_{oss}$		100		pF	
Reverse transfer capacitance	$C_{rss}$		65		pF	
Turn-on delay time	$t_{d(on)}$		7.5		nS	$V_{GS}=-10V, V_{DS}=-15V, R_{GEN}=3\Omega, R_L=3.65\Omega$
Turn-on rise time	$t_r$		5.5		nS	
Turn-off delay time	$t_{d(off)}$		19		nS	
Turn-off fall time	$t_f$		7		nS	
Total gate charge	$Q_g$		4.6	6	nC	$V_{DS}=-15V, V_{GS}=-4.5V, I_D=-4.1A$
			9.2	11	nC	
Gate-source charge	$Q_{gs}$		1.6		nC	$V_{DS}=-15V, V_{GS}=-10V, I_D=-4.1A$
Gate-drain charge	$Q_{gd}$		2.2		nC	
Diode forward voltage	$V_{SD}$		-0.7	-1	V	$I_S=-1A, V_{GS}=0V$
Diode forward current	$I_S$			-2	A	
Body Diode Reverse Recovery Time	$t_{rr}$		11		nS	$I_F=-4.1A, dI/dt=100A/\mu s$
Body Diode Reverse Recovery Charge	$Q_{rr}$		5.3		nC	

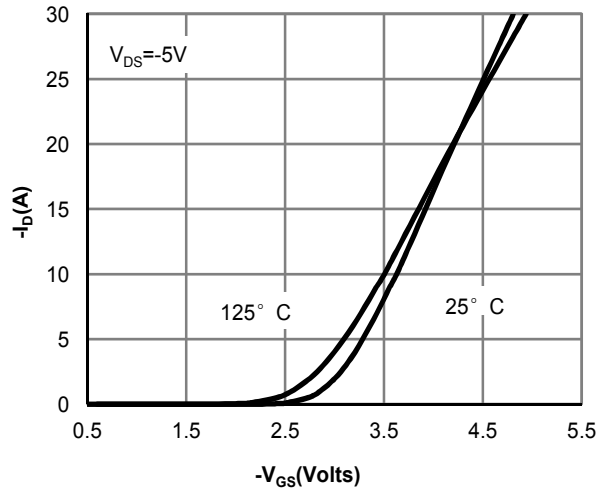
\* Pulse test ; Pulse width  $\leq 300\mu s$ , Duty cycle  $\leq 0.5\%$  .

**LOW VOLTAGE MOSFET (P-CHANNEL)**

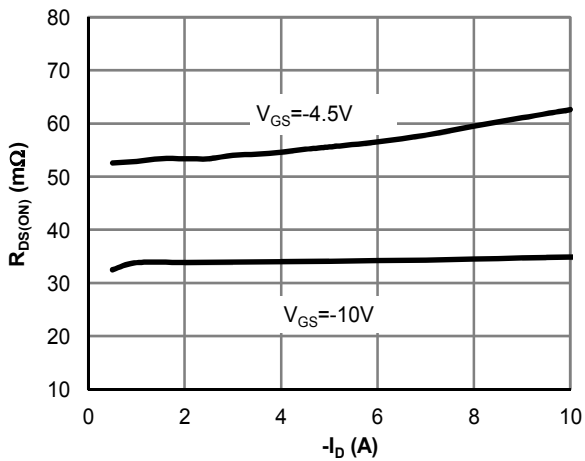
**Typical Characteristics**



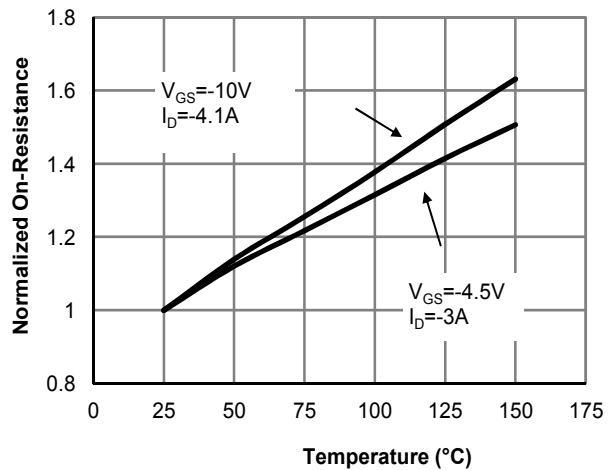
**Fig 1: On-Region Characteristics**



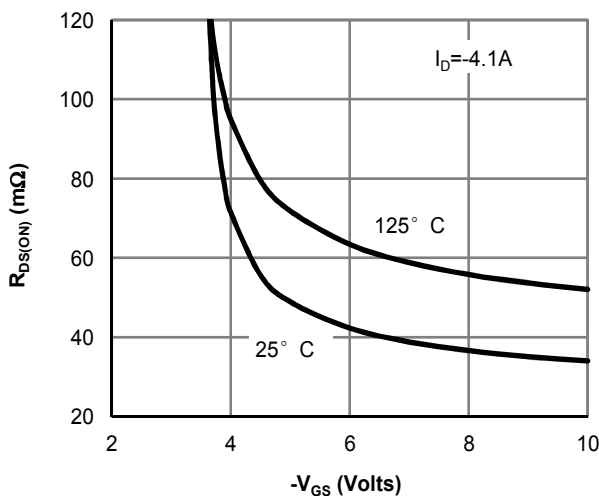
**Figure 2: Transfer Characteristics**



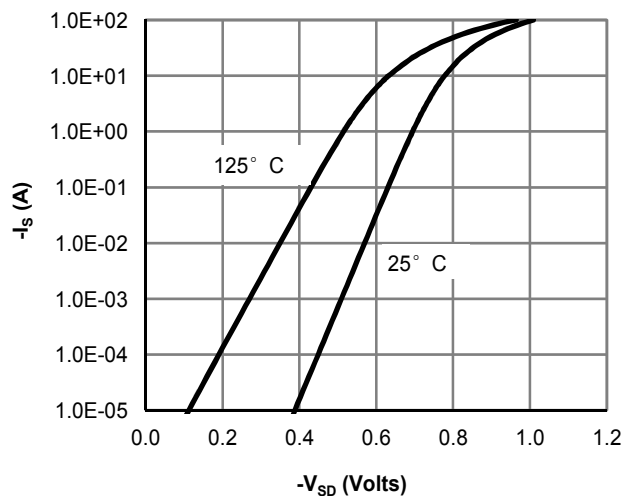
**Figure 3: On-Resistance vs. Drain Current and Gate Voltage**



**Figure 4: On-Resistance vs. Junction Temperature**

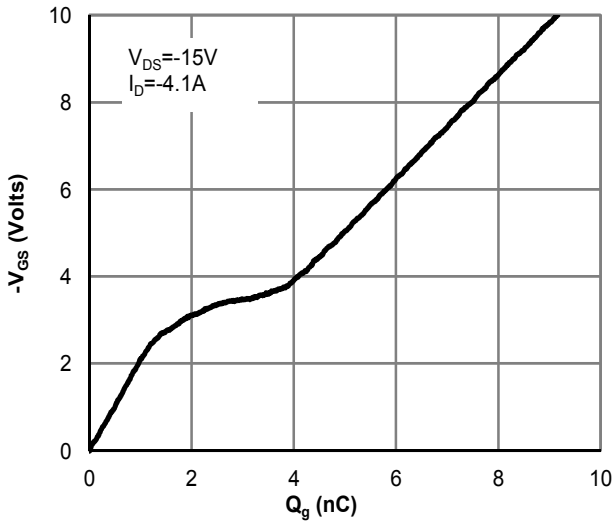


**Figure 5: On-Resistance vs. Gate-Source Voltage**

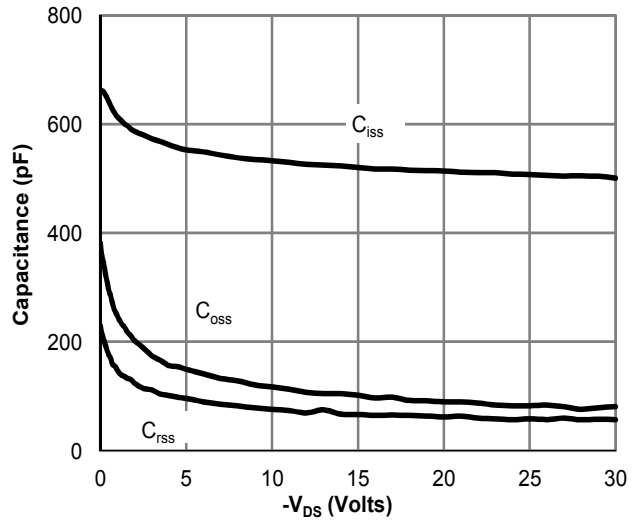


**Figure 6: Body-Diode Characteristics**

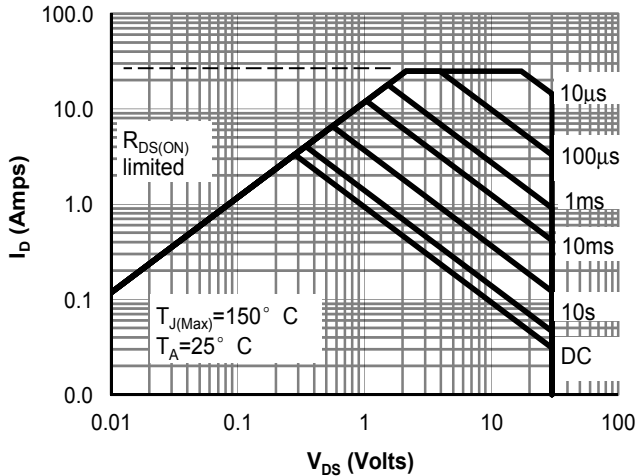
**LOW VOLTAGE MOSFET (P-CHANNEL)**



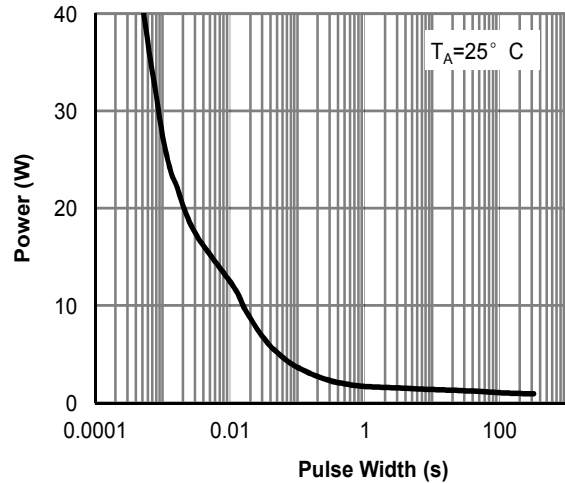
**Figure 7: Gate-Charge Characteristics**



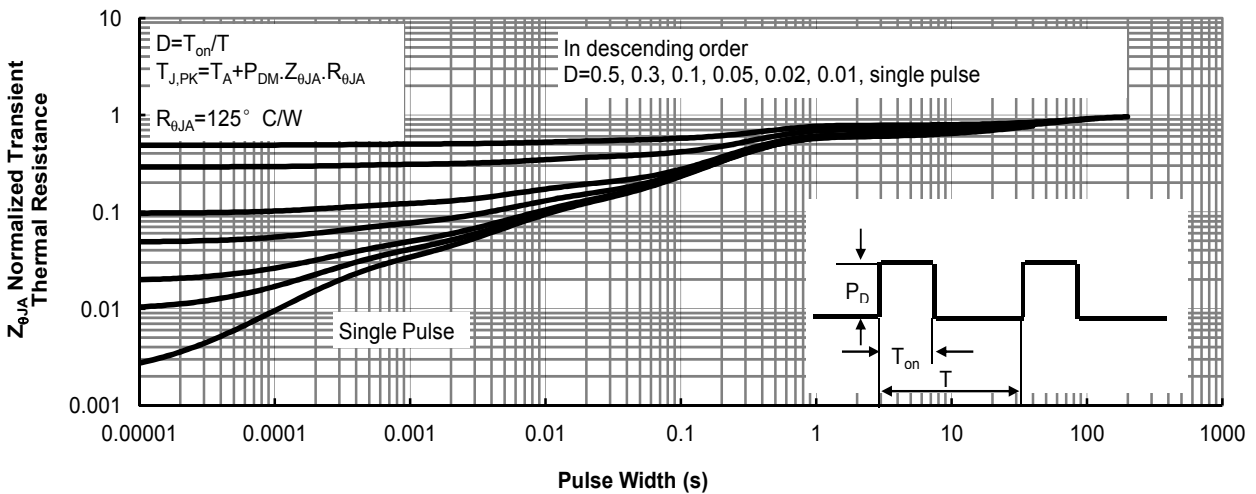
**Figure 8: Capacitance Characteristics**



**Figure 9: Maximum Forward Biased Safe Operating Area**



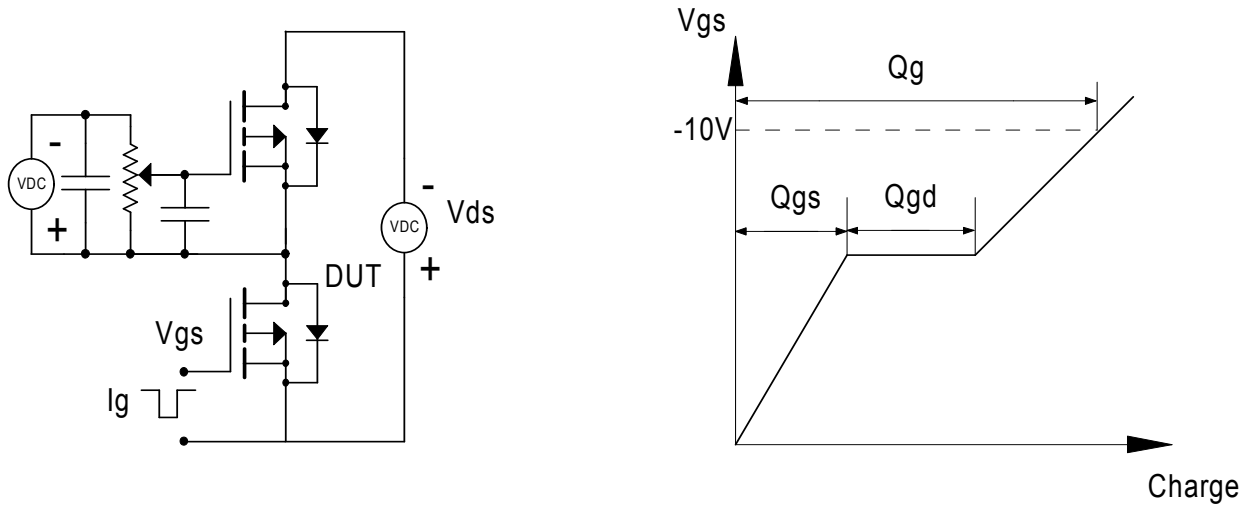
**Figure 10: Single Pulse Power Rating Junction-to-Ambient**



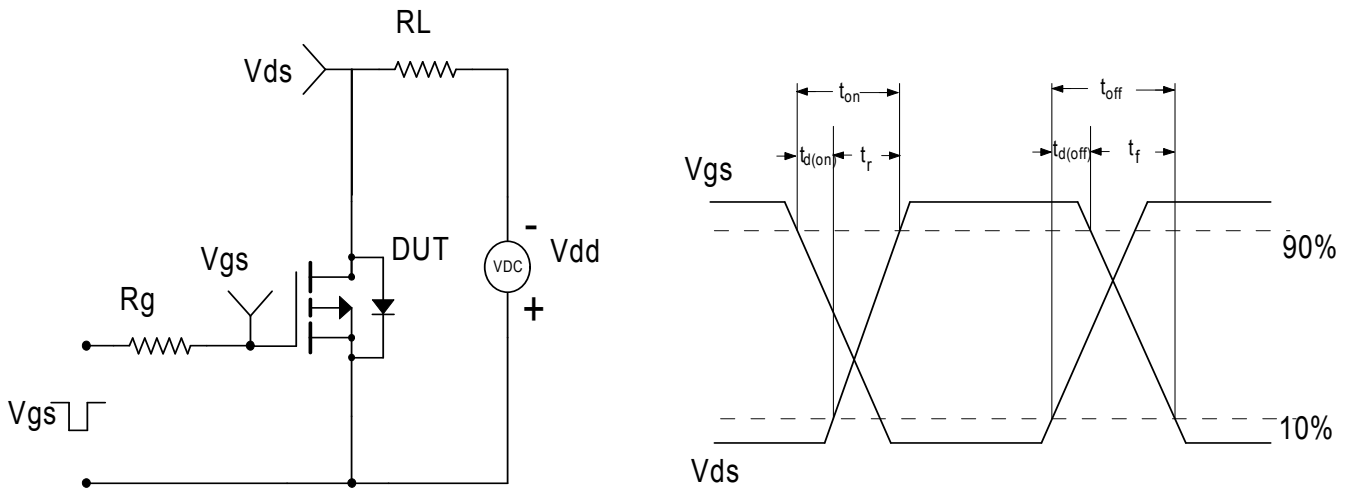
**Figure 11: Normalized Maximum Transient Thermal Impedance**

LOW VOLTAGE MOSFET (P-CHANNEL)

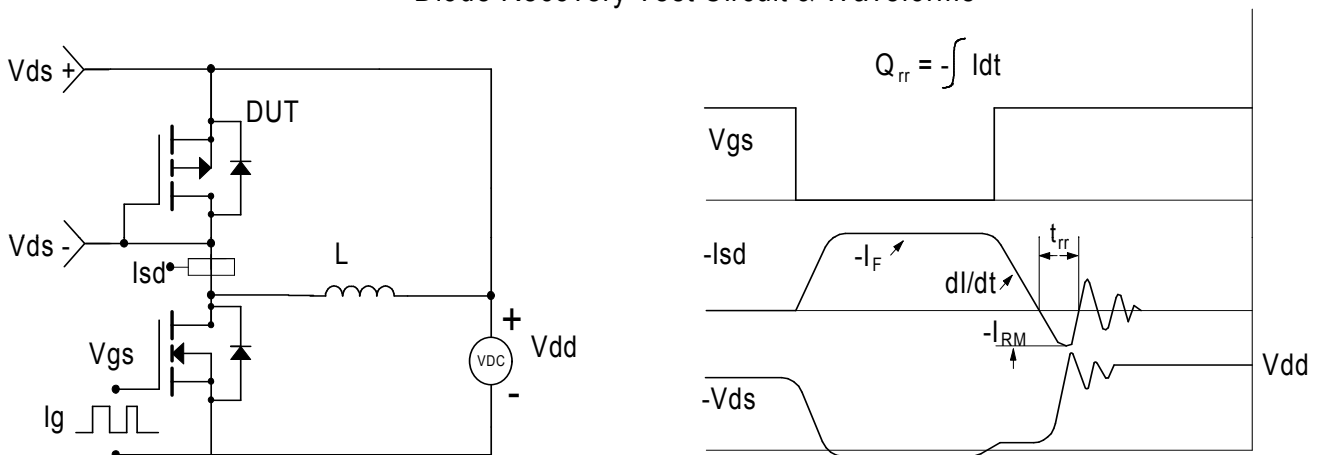
Gate Charge Test Circuit & Waveform



Resistive Switching Test Circuit & Waveforms

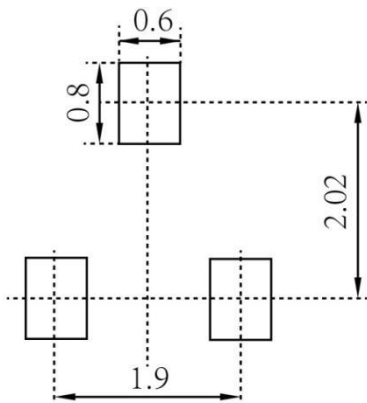


Diode Recovery Test Circuit & Waveforms



**LOW VOLTAGE MOSFET (P-CHANNEL)**
**SOT-23 Package Outline Dimensions**


Symbol	Dimensions In Millimeters		Dimensions In Inches	
	Min.	Max.	Min.	Max.
A	0.900	1.150	0.035	0.045
A1	0.000	0.100	0.000	0.004
A2	0.900	1.050	0.035	0.041
b	0.300	0.500	0.012	0.020
c	0.080	0.150	0.003	0.006
D	2.800	3.000	0.110	0.118
E	1.200	1.400	0.047	0.055
E1	2.250	2.550	0.089	0.100
e	0.950 TYP		0.037 TYP	
e1	1.800	2.000	0.071	0.079
L	0.550 REF		0.022 REF	
L1	0.300	0.500	0.012	0.020
θ	0°	8°	0°	8°

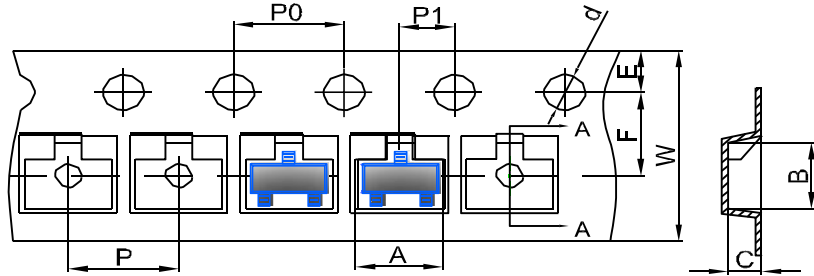
**SOT-23 Suggested Pad Layout**

**Note:**

1. Controlling dimension: in millimeters
2. General tolerance:  $\pm 0.05\text{mm}$
3. The pad layout is for reference purposes only

LOW VOLTAGE MOSFET (P-CHANNEL)

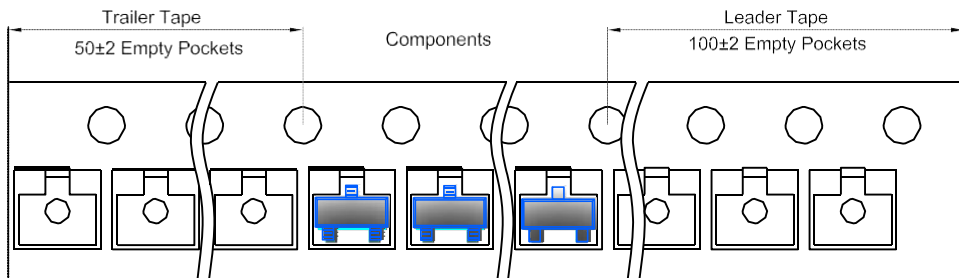
SOT-23 Tape and Reel

SOT-23 Embossed Carrier Tape

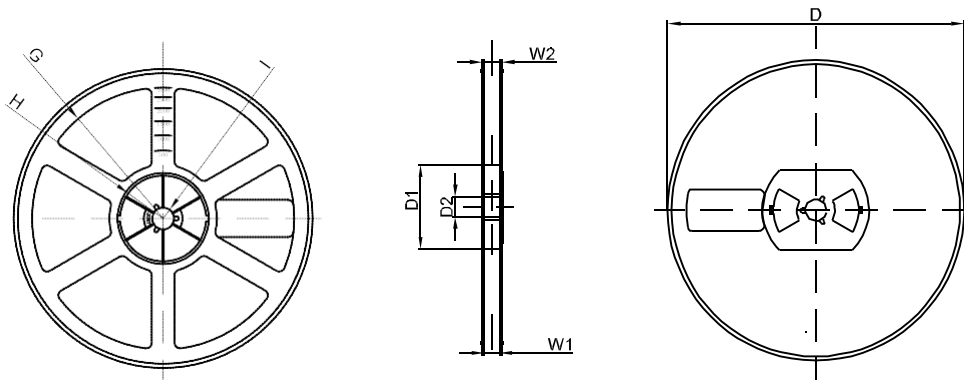


DIMENSIONS ARE IN MILLIMETER										
TYPE	A	B	C	d	E	F	P0	P	P1	W
SOT-23	3.15	2.77	1.22	Ø1.50	1.75	3.50	4.00	4.00	2.00	8.00
TOLERANCE	±0.1	±0.1	±0.1	±0.1	±0.1	±0.1	±0.1	±0.1	±0.1	±0.1

SOT-23 Tape Leader and Trailer



SOT-23 Reel



DIMENSIONS ARE IN MILLIMETER								
REEL OPTION	D	D1	D2	G	H	I	W1	W2
7" DIA	Ø178	54.40	13.00	R78	R25.60	R6.50	9.50	12.30
TOLERANCE	±2	±1	±1	±1	±1	±1	±1	±1