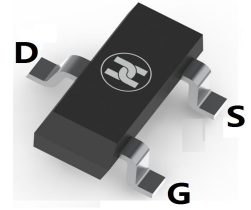
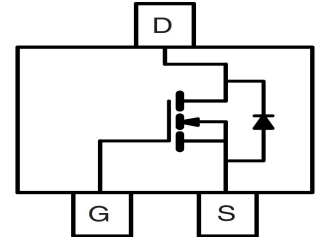


**LOW VOLTAGE MOSFET (N-CHANNEL)**
**FEATURES**

- Ultra low on-resistance:  $V_{DS}=20V, R_{DS(ON)} \leq 62m\Omega @ V_{GS}=4.5V, I_D=3A$
- For PWM application
- For Load switch application
- Surface Mount device


**SOT-23**

**MECHANICAL DATA**

- Case: SOT-23
- Case Material: Molded Plastic. UL flammability
- Classification Rating: 94V-0
- Weight: 0.008 grams (approximate)

**MAXIMUM RATINGS ( $T_A = 25^\circ C$  unless otherwise noted)**

Parameter	Symbol	Value	Unit
Drain-source voltage	$V_{DS}$	20	V
Gate-source voltage	$V_{GS}$	$\pm 8$	V
Continuous drain current	$T_A=25^\circ C$	$I_D$	3
	$T_A=70^\circ C$	$I_D$	2.5
Pulsed drain current	$I_{DM}^*$	16	A
Power dissipation	$T_A=25^\circ C$	$P_D$	1.4
	$T_A=70^\circ C$	$P_D$	0.9
Thermal resistance from Junction to ambient	$R_{\theta JA}$	125	$^\circ C/W$
Junction temperature	$T_J$	150	$^\circ C$
Storage temperature	$T_{STG}$	-55 ~ +150	$^\circ C$

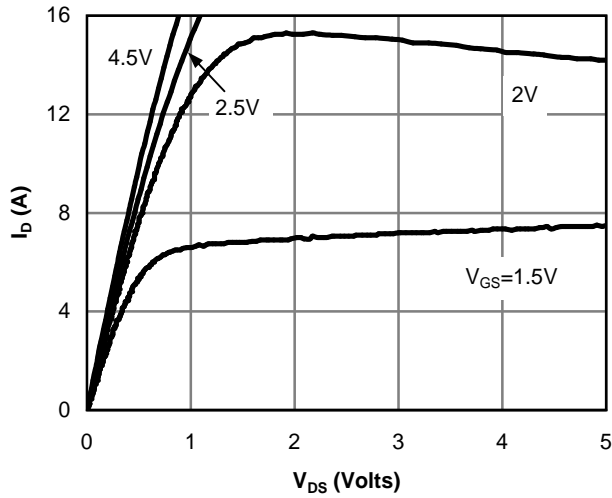
**ELECTRICAL CHARACTERISTICS ( $T_A = 25^\circ C$  unless otherwise specified)**

Parameter	Symbol	Min	Typ	Max	Unit	Conditions
Drain-Source breakdown voltage	$V_{(BR)DSS}^*$	20			V	$V_{GS}=0V, I_D=250\mu A$
Zero gate voltage drain current	$I_{DSS}^*$			1	$\mu A$	$V_{DS}=20V, V_{GS}=0V$
Gate-body leakage current	$I_{GSS}^*$			$\pm 100$	nA	$V_{DS}=0V, V_{GS}=\pm 8V$
Gate-threshold voltage	$V_{GS(th)}^*$	0.5	0.7	1	V	$V_{DS}=V_{GS}, I_D=250\mu A$
Drain-source on-resistance	$R_{DS(ON)}^*$		51	62	m $\Omega$	$V_{GS}=4.5V, I_D=3A$
			58	70	m $\Omega$	$V_{GS}=2.5V, I_D=2.8A$
			68	85	m $\Omega$	$V_{GS}=1.8V, I_D=2.5A$
On-State Drain Current	$I_{D(ON)}^*$	16			A	$V_{DS}=5V, V_{GS}=4.5V$
Forward transconductance	$g_{FS}$		11		S	$V_{DS}=5V, I_D=3A$
Gate resistance	$R_g$		3	4.5	$\Omega$	$V_{GS}=0V, V_{DS}=0V, f=1MHz$
Input capacitance	$C_{iss}$		260	320	pF	$V_{DS}=10V, V_{GS}=0V, f=1MHz$
Output capacitance	$C_{oss}$		48		pF	
Reverse transfer capacitance	$C_{rss}$		27		pF	
Turn-on delay time	$t_{d(on)}$		2.5		nS	$V_{DS}=10V, V_{GS}=5V, R_{GEN}=6\Omega, R_L=3.3\Omega$
Turn-on rise time	$t_r$		3.2		nS	
Turn-off delay time	$t_{d(off)}$		21		nS	
Turn-off fall time	$t_f$		3		nS	
Total gate charge	$Q_g$		2.9	3.8	nC	$V_{DS}=10V, V_{GS}=4.5V, I_D=3A$
Gate-source charge	$Q_{gs}$		0.4		nC	
Gate-drain charge	$Q_{gd}$		0.6		nC	
Diode forward voltage	$V_{SD}$		0.75	1	V	$I_S=1A, V_{GS}=0V$
Diode forward current	$I_S$			1.5	A	
Body Diode Reverse Recovery Time	$t_{rr}$		14	19	nS	$I_F=3A, dI/dt=100A/\mu s$
Body Diode Reverse Recovery Charge	$Q_{rr}$		3.8		nC	$I_F=3A, dI/dt=100A/\mu s$

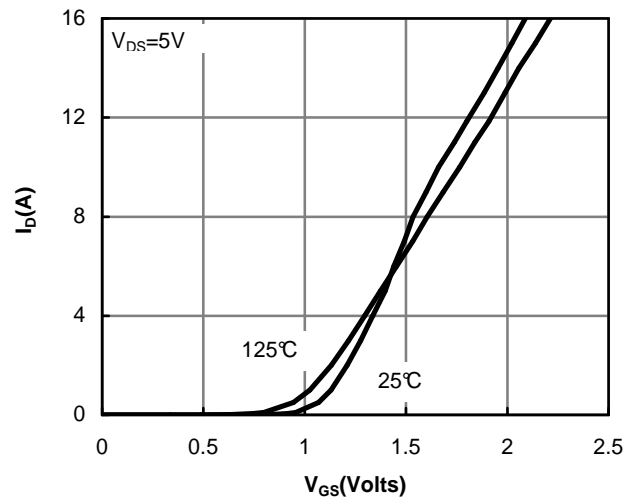
\*Pulse test ; Pulse width  $\leq 300\mu s$ , Duty cycle  $\leq 0.5\%$  .

**LOW VOLTAGE MOSFET (N-CHANNEL)**

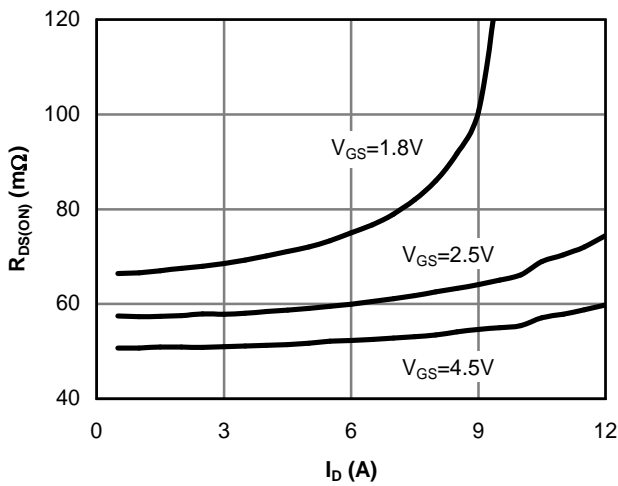
**Typical Characteristics**



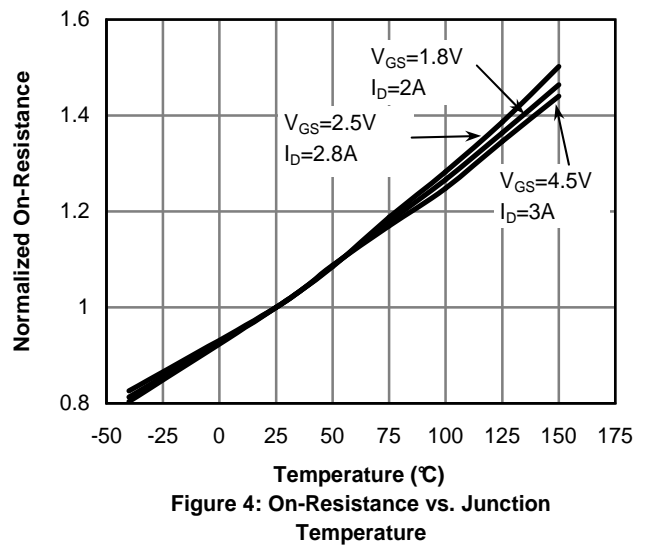
**Figure 1: On-Region Characteristics**



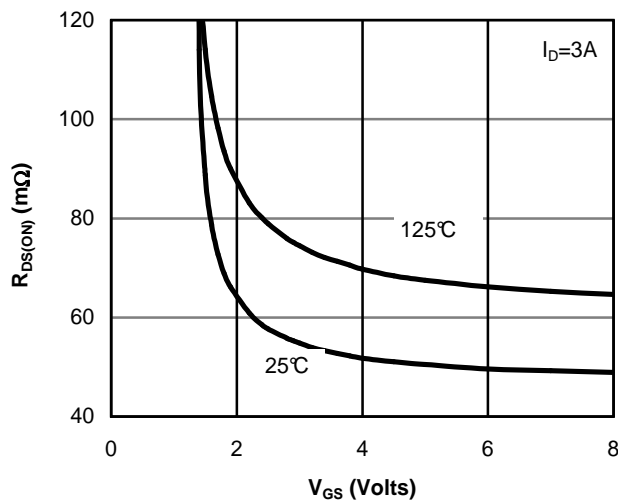
**Figure 2: Transfer Characteristics**



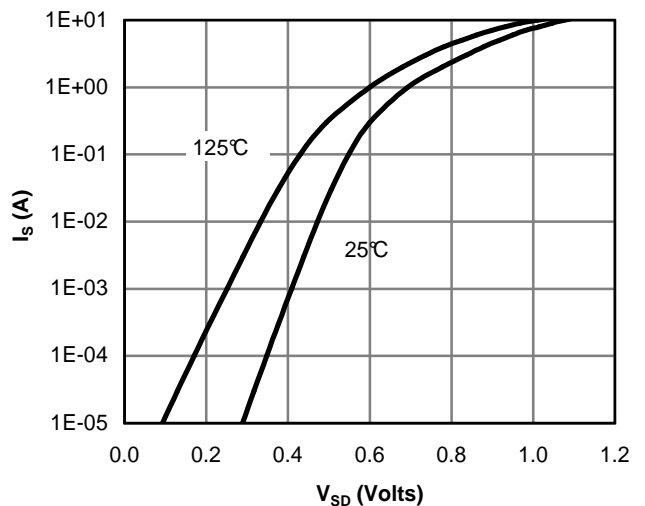
**Figure 3: On-Resistance vs. Drain Current and Gate Voltage**



**Figure 4: On-Resistance vs. Junction Temperature**

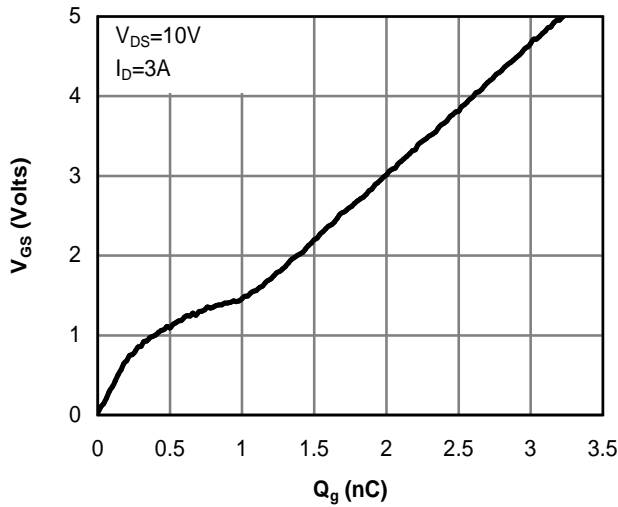


**Figure 5: On-Resistance vs. Gate-Source Voltage**

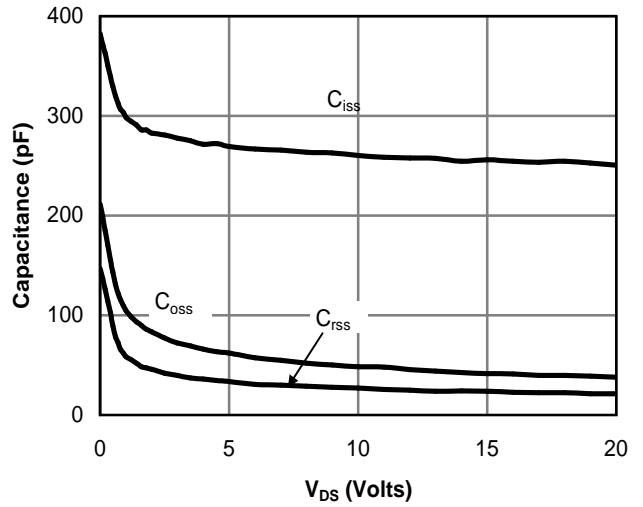


**Figure 6: Body-Diode Characteristics**

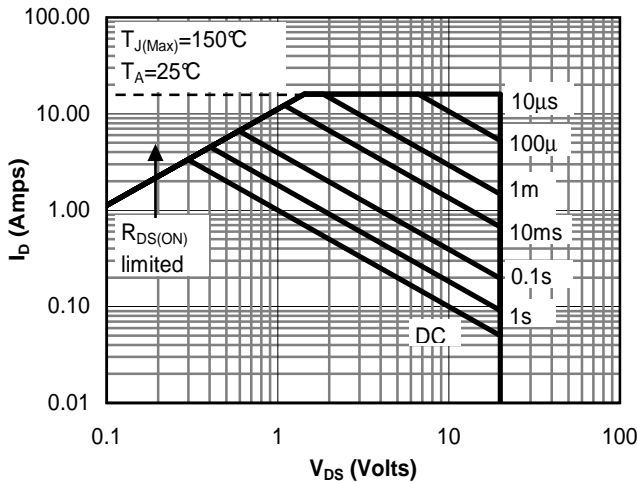
**LOW VOLTAGE MOSFET (N-CHANNEL)**



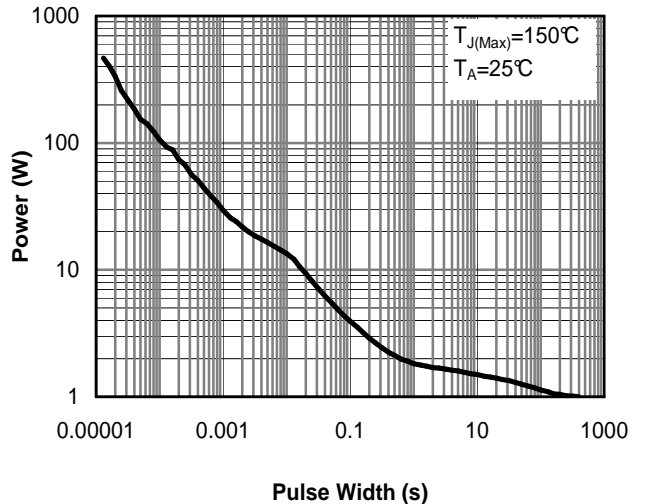
**Figure 7: Gate-Charge Characteristics**



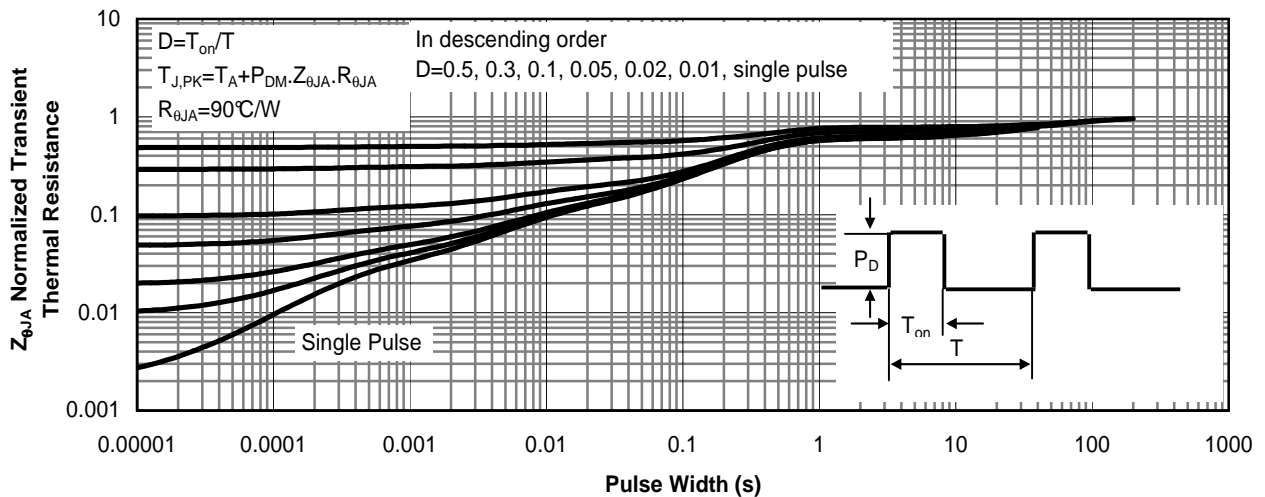
**Figure 8: Capacitance Characteristics**



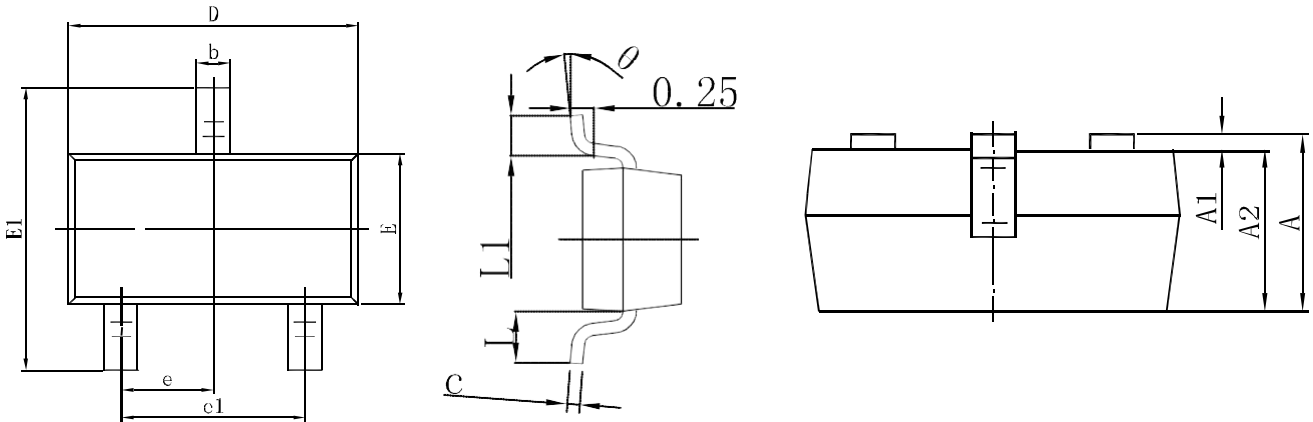
**Figure 9: Maximum Forward Biased Safe Operating Area**



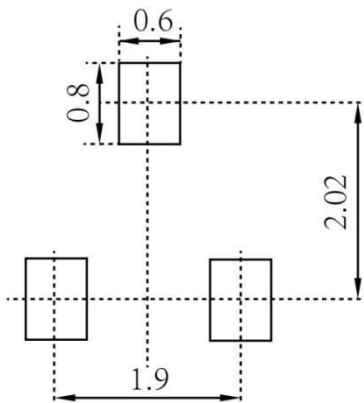
**Figure 10: Single Pulse Power Rating Junction-to-Ambient**



**Figure 11: Normalized Maximum Transient Thermal Impedance**

**LOW VOLTAGE MOSFET (N-CHANNEL)**
**SOT-23 Package Outline Dimensions**


Symbol	Dimensions In Millimeters		Dimensions In Inches	
	Min.	Max.	Min.	Max.
A	0.900	1.150	0.035	0.045
A1	0.000	0.100	0.000	0.004
A2	0.900	1.050	0.035	0.041
b	0.300	0.500	0.012	0.020
c	0.080	0.150	0.003	0.006
D	2.800	3.000	0.110	0.118
E	1.200	1.400	0.047	0.055
E1	2.250	2.550	0.089	0.100
e	0.950 TYP		0.037 TYP	
e1	1.800	2.000	0.071	0.079
L	0.550 REF		0.022 REF	
L1	0.300	0.500	0.012	0.020
θ	0°	8°	0°	8°

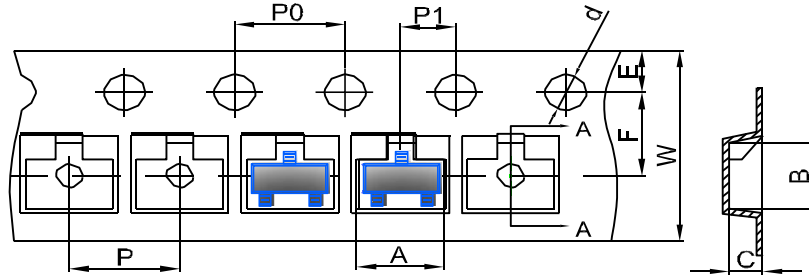
**SOT-23 Suggested Pad Layout**

**Note:**

1. Controlling dimension: in millimeters
2. General tolerance:  $\pm 0.05\text{mm}$
3. The pad layout is for reference purposes only

LOW VOLTAGE MOSFET (N-CHANNEL)

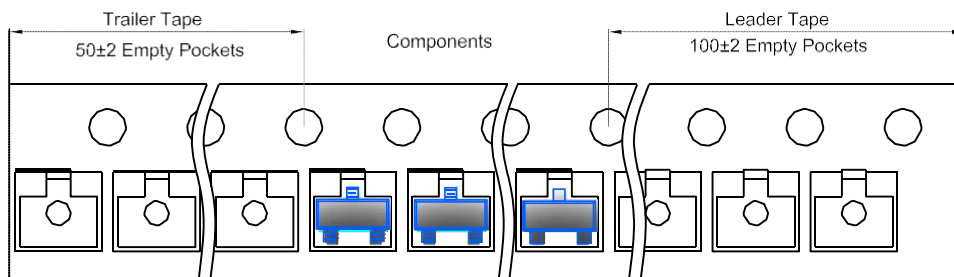
SOT-23 Tape and Reel

SOT-23 Embossed Carrier Tape

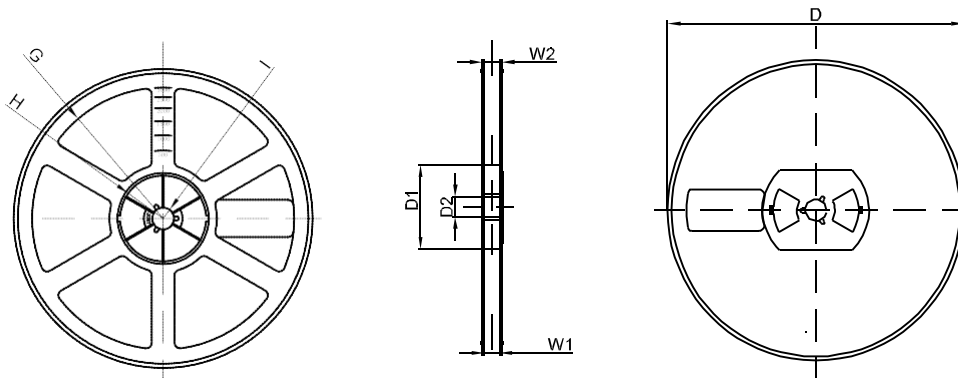


DIMENSIONS ARE IN MILLIMETER										
TYPE	A	B	C	d	E	F	P0	P	P1	W
SOT-23	3.15	2.77	1.22	Ø1.50	1.75	3.50	4.00	4.00	2.00	8.00
TOLERANCE	±0.1	±0.1	±0.1	±0.1	±0.1	±0.1	±0.1	±0.1	±0.1	±0.1

SOT-23 Tape Leader and Trailer



SOT-23 Reel



DIMENSIONS ARE IN MILLIMETER								
REEL OPTION	D	D1	D2	G	H	I	W1	W2
7" DIA	Ø178	54.40	13.00	R78	R25.60	R6.50	9.50	12.30
TOLERANCE	±2	±1	±1	±1	±1	±1	±1	±1