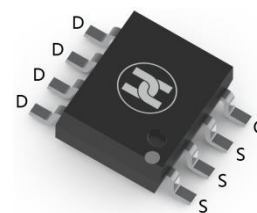
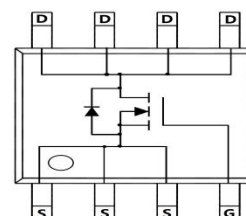

**LOW VOLTAGE MOSFET (N-CHANNEL)**
**FEATURES**

- Ultra low on-resistance:  $V_{DS}=36V, I_D=27A, R_{DS(ON)} \leq 3.1m\Omega @ V_{GS}=10V$
- Most efficient high frequency switching performance
- For general purpose applications
- Surface Mount device

**SOP-8**

**MECHANICAL DATA**

- Case: SOP-8
- Case Material: Molded Plastic. UL flammability
- Classification Rating: 94V-0
- Weight: 0.3 grams (approximate)

**MAXIMUM RATINGS ( $T_A = 25^\circ C$  unless otherwise noted)**

Parameter	Symbol	Value	Unit
Drain-source voltage	$V_{DS}$	36	V
Gate-source voltage	$V_{GS}$	$\pm 20$	V
Continuous drain current	$I_D$	$T_A = 25^\circ C$	27
		$T_A = 70^\circ C$	22
Pulsed drain current	$I_{DM}$	390	A
Avalanche current	$I_{AS}, I_{AR}$	67	A
Avalanche energy $L=0.1mH$	$E_{AS}, E_{AR}$	224	mJ
Power dissipation	$P_D$	$T_A = 25^\circ C$	3.6
		$T_A = 70^\circ C$	2.3
Thermal resistance from Junction to ambient	$R_{\theta JA}$	65	$^\circ C/W$
Thermal resistance from Junction to Lead	$R_{\theta JL}$	15	$^\circ C/W$
Junction temperature	$T_J$	150	$^\circ C$
Storage temperature	$T_{STG}$	-55 ~ +150	$^\circ C$

**ELECTRICAL CHARACTERISTICS ( $T_A = 25^\circ C$  unless otherwise specified)**

Parameter	Symbol	Min	Typ	Max	Unit	Conditions
Drain-Source breakdown voltage	$V_{(BR)DSS}^*$	36			V	$V_{GS}=0V, I_D=250\mu A$
Zero gate voltage drain current	$I_{DSS}^*$			1	$\mu A$	$V_{DS}=36V, V_{GS}=0V$
Gate-body leakage current	$I_{GSS}^*$			$\pm 100$	nA	$V_{DS}=0V, V_{GS}=\pm 20V$
Gate-threshold voltage	$V_{GS(th)}^*$	1.2	1.8	2.3	V	$V_{DS}=V_{GS}, I_D=250\mu A$
On-State Drain Current	$I_{D(ON)}$	390			A	$V_{DS}=5V, V_{GS}=10V$
Drain-source on-resistance	$R_{DS(ON)}^*$		2.6	3.1	m $\Omega$	$V_{GS}=10V, I_D=20A$
			3.7	4.5	m $\Omega$	$V_{GS}=10V, I_D=20A, T_J=125^\circ C$
			3.3	4.2	m $\Omega$	$V_{GS}=4.5V, I_D=20A$
Forward transconductance	$g_{FS}$		151		S	$V_{DS}=5V, I_D=12A$
Diode forward voltage	$V_{SD}$		0.7	1	V	$I_S=1A, V_{GS}=0V$
Diode forward current	$I_S$			5	A	
Input capacitance	$C_{iss}$	2595	3248	3900	pF	$V_{DS}=18V, V_{GS}=0V, f=1MHz$
Output capacitance	$C_{oss}$	790	1130	1470	pF	
Reverse transfer capacitance	$C_{rss}$	16	54	95	pF	
Gate resistance	$R_g$	0.8	1.8	2.7	$\Omega$	$V_{DS}=0V, V_{GS}=0V, f=1MHz$
Total gate charge	$Q_g$	16	20.6	27	nC	$V_{GS}=4.5V, V_{DS}=18V, I_D=20A$
Total gate charge		37	46.4	57	nC	
Gate-source charge	$Q_{gs}$		8		nC	$V_{GS}=10V, V_{DS}=18V, I_D=20A$
Gate-drain charge	$Q_{gd}$		6.2		nC	
Turn-on delay time	$t_{d(on)}$		8.5		nS	$V_{GS}=10V, V_{DS}=18V, R_{GEN}=3\Omega, R_L=0.9\Omega$
Turn-on rise time	$t_r$		4.8		nS	
Turn-off delay time	$t_{d(off)}$		40.8		nS	
Turn-off fall time	$t_f$		9.8		nS	
Body Diode Reverse Recovery Time	$t_{rr}$	17	21.7	26	nS	$I_F=20A, di/dt=500A/\mu s$
Body Diode Reverse Recovery Charge	$Q_{rr}$	48	60.5	73	nC	$I_F=20A, di/dt=500A/\mu s$

\*Pulse test ; Pulse width  $\leq 300\mu s$ , Duty cycle  $\leq 0.5\%$  .

**LOW VOLTAGE MOSFET (N-CHANNEL)**

**TYPICAL ELECTRICAL AND THERMAL CHARACTERISTICS**

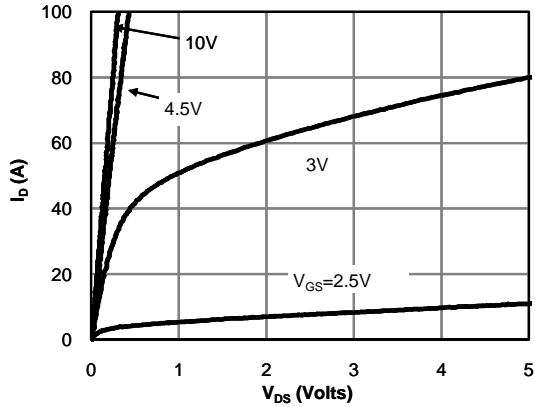

Fig 1: On-Region Characteristics

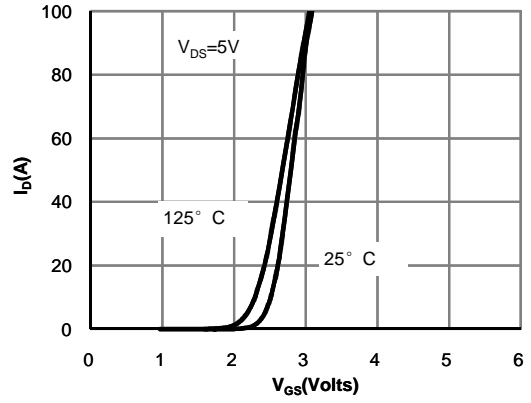

Figure 2: Transfer Characteristics

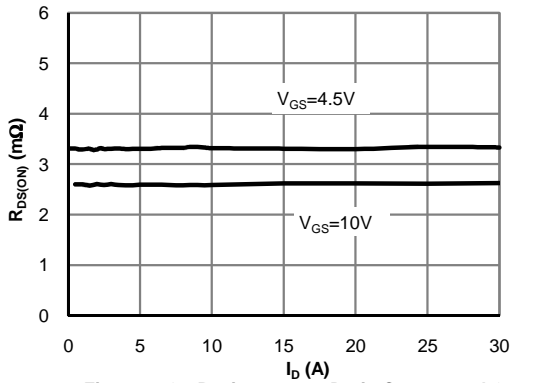

Figure 3: On-Resistance vs. Drain Current and Gate Voltage

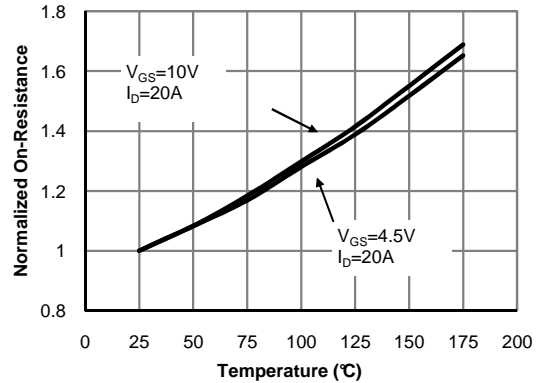

Figure 4: On-Resistance vs. Junction Temperature

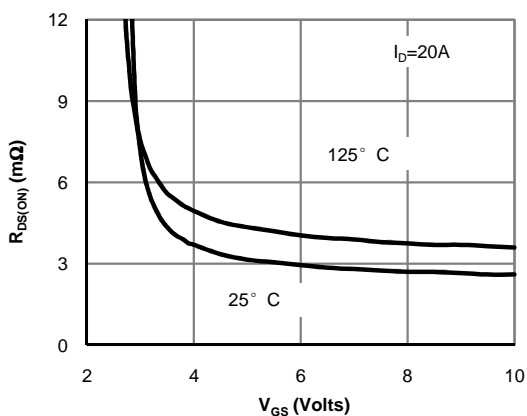

Figure 5: On-Resistance vs. Gate-Source Voltage

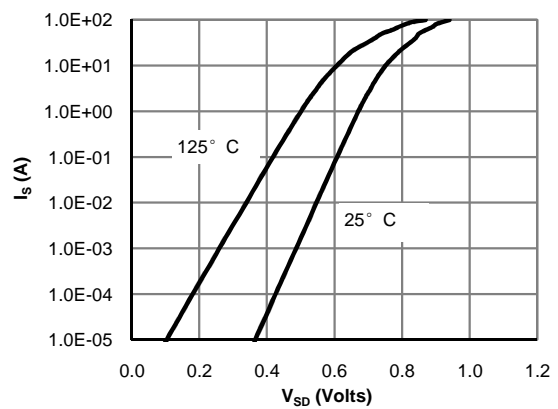
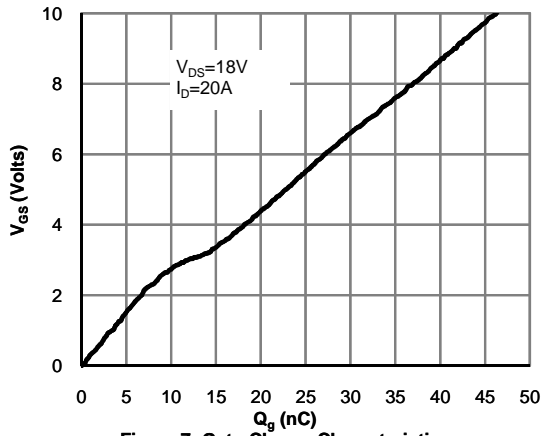

Figure 6: Body-Diode Characteristics

**LOW VOLTAGE MOSFET (N-CHANNEL)**

**TYPICAL ELECTRICAL AND THERMAL CHARACTERISTICS**



**Figure 7: Gate-Charge Characteristics**

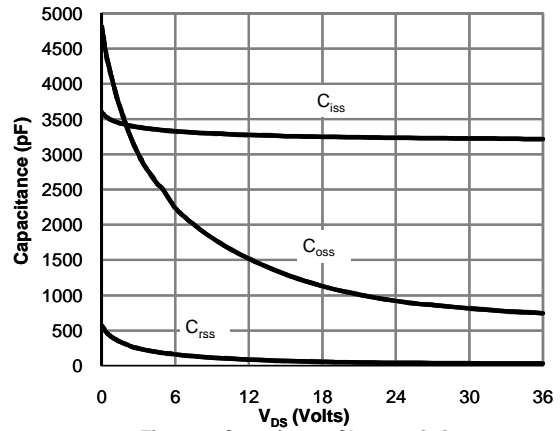

**Figure 8: Capacitance Characteristics**

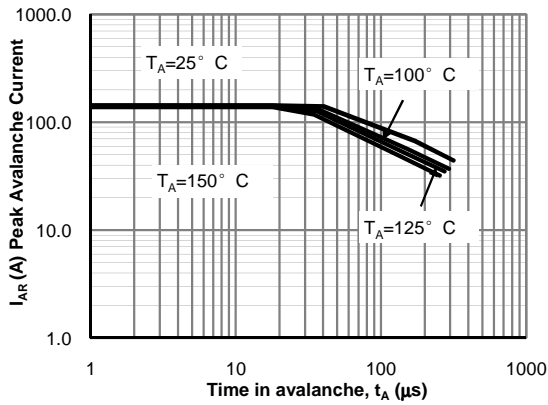

**Figure 12: Single Pulse Avalanche capability**

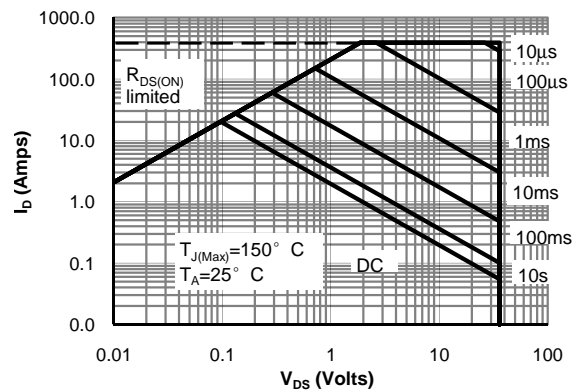

**Figure 10: Maximum Forward Biased Safe Operating Area**

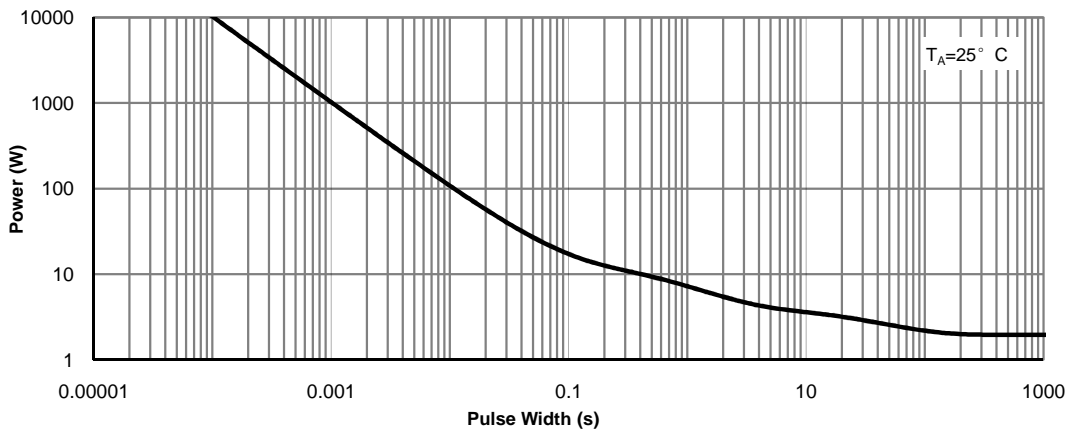

**Figure 11: Single Pulse Power Rating Junction-to-Ambient**

**LOW VOLTAGE MOSFET (N-CHANNEL)**

**TYPICAL ELECTRICAL AND THERMAL CHARACTERISTICS**

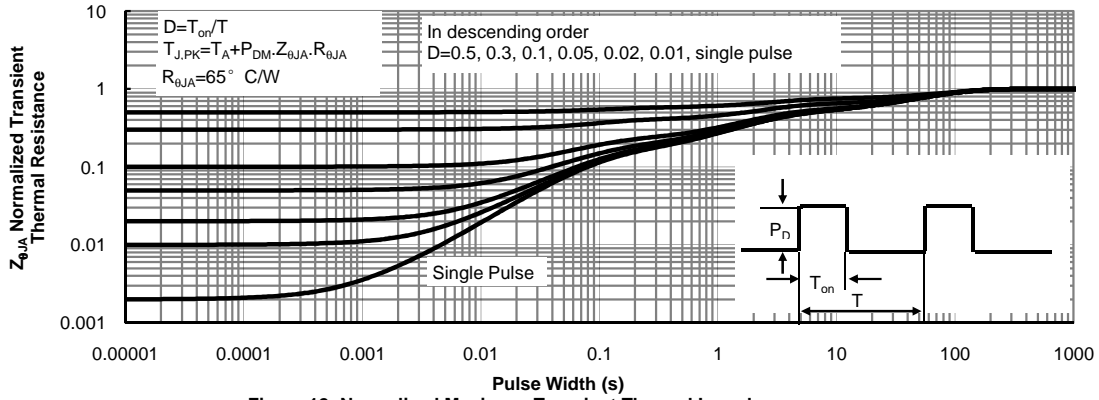

**LOW VOLTAGE MOSFET (N-CHANNEL)**

**Gate Charge Test Circuit & Waveform**

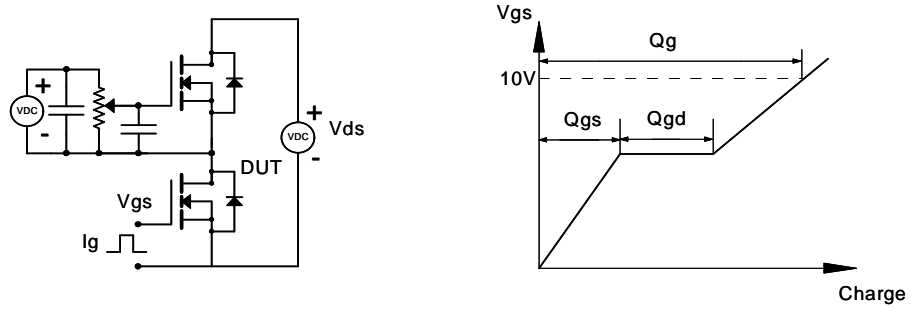

**Resistive Switching Test Circuit & Waveforms**

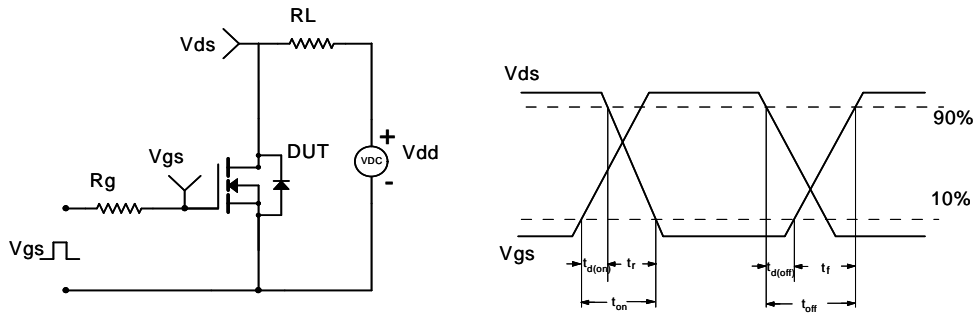

**Unclamped Inductive Switching (UIS) Test Circuit & Waveforms**

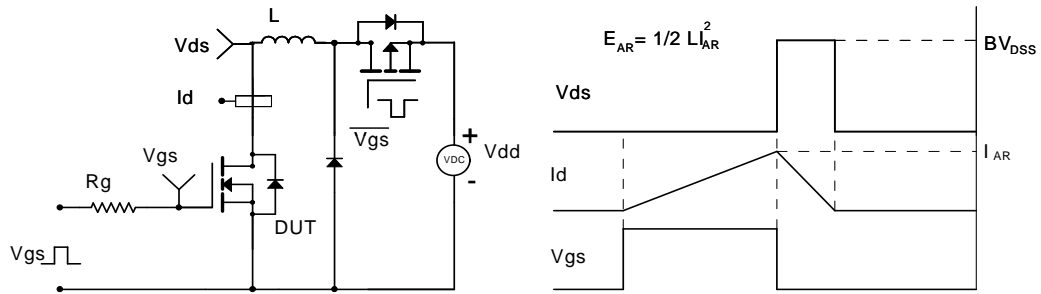

**Diode Recovery Test Circuit & Waveforms**

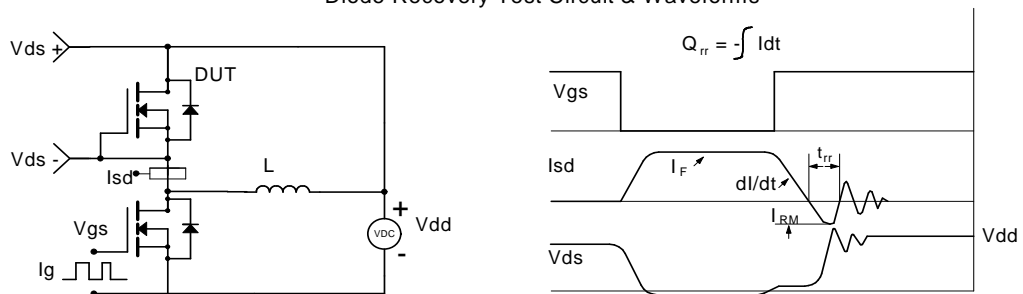

LOW VOLTAGE MOSFET (N-CHANNEL)

SOP-8 Package Outline Dimensions

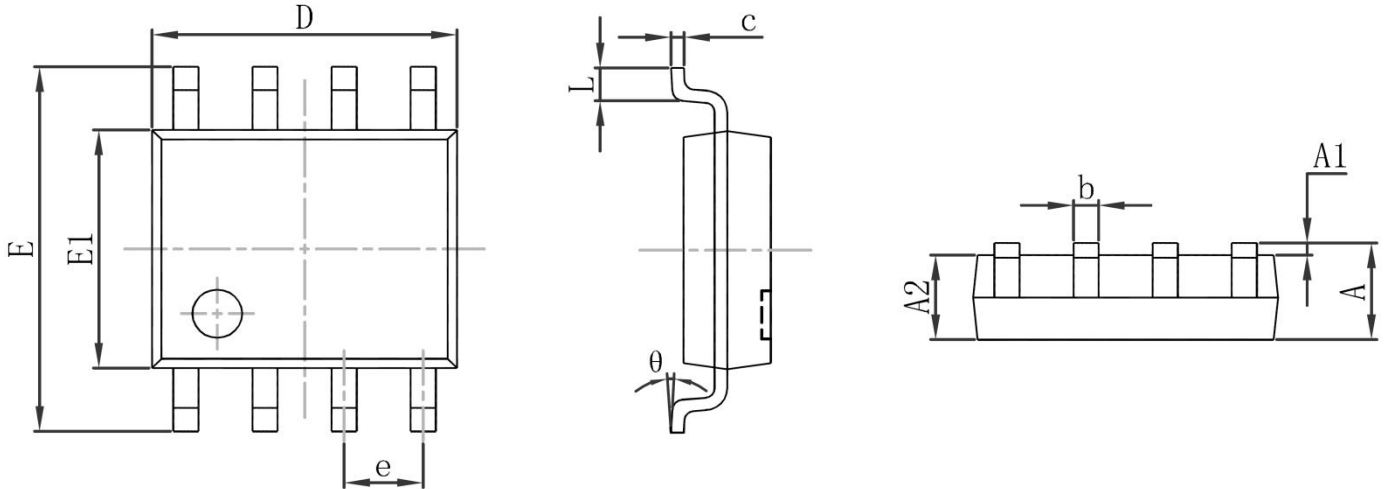

Symbol	Dimensions In Millimeters		Dimensions In Inches	
	Min.	Max.	Min.	Max.
A	1.350	1.750	0.053	0.069
A1	0.100	0.250	0.004	0.010
A2	1.350	1.550	0.053	0.061
b	0.330	0.510	0.013	0.020
c	0.170	0.250	0.007	0.010
D	4.800	5.000	0.189	0.197
e	1.270(BSC)		0.050 (BSC)	
E	5.800	6.200	0.228	0.244
E1	3.800	4.000	0.150	0.157
L	0.400	1.270	0.016	0.050
θ	0°	8°	0°	8°

SOP-8 Suggested Pad Layout

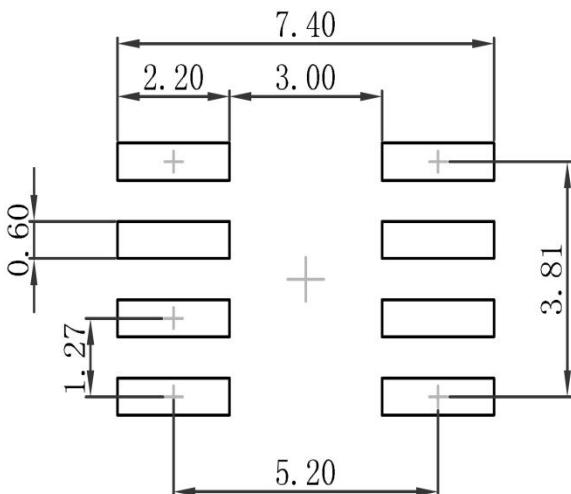

Note:

1. Controlling dimension: in millimeters
2. General tolerance: ±0.05mm
3. The pad layout is for reference purposes only

LOW VOLTAGE MOSFET (N-CHANNEL)

SOP-8 Tape and Reel

SOP-8 Embossed Carrier Tape

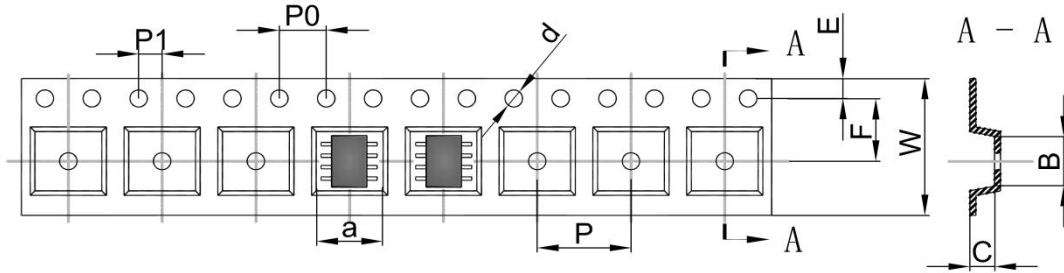

DIMENSIONS ARE IN MILLIMETER										
TYPE	A	B	C	d	E	F	P0	P	P1	W
SOP-8	6.40	5.40	2.10	Ø1.50	1.75	5.50	4.00	8.00	2.00	12.00
TOLERANCE	±0.1	±0.1	±0.1	±0.1	±0.1	±0.1	±0.1	±0.1	±0.1	±0.1

SOP-8 Tape Leader and Trailer

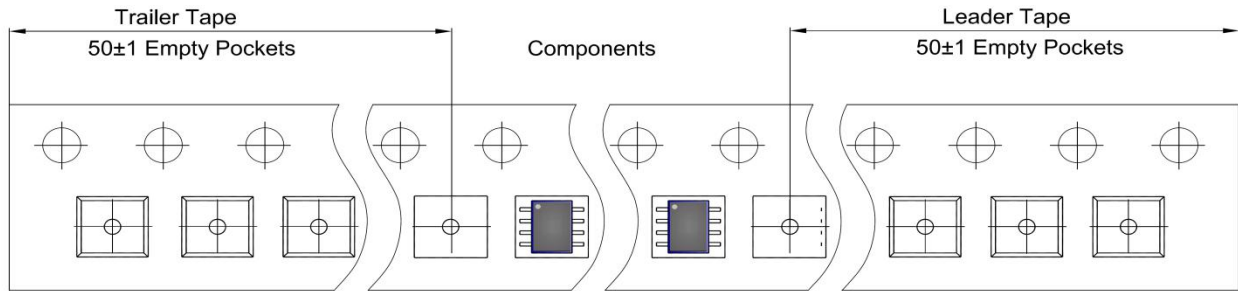

SOP-8 Reel

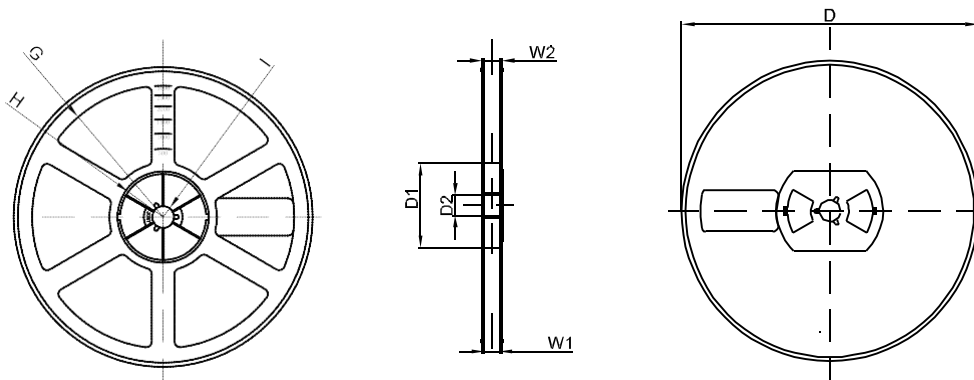

DIMENSIONS ARE IN MILLIMETER								
REEL OPTION	D	D1	D2	G	H	I	W1	W2
13" DIA	Ø330.00	100.00	13.00	R151.00	R56.00	R6.50	12.40	17.60
TOLERANCE	±2	±1	±1	±1	±1	±1	±1	±1