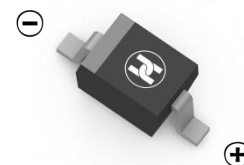
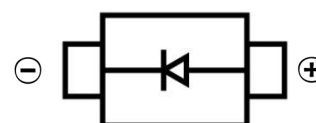

**SCHOTTKY BARRIER DIODE**
**FEATURES**

- Low Forward Voltage
- High Conductance
- Surface Mount device
- Guard Ring Construction for Transient Protection
- For Low Current Rectifier Circuits Applications

**SOD-323**
**MECHANICAL DATA**

- Case: SOD-323
- Case Material: Molded Plastic. UL flammability
- Classification Rating: 94V-0
- Weight: 0.005 grams (approximate)

**MAXIMUM RATINGS (T<sub>A</sub> = 25°C unless otherwise noted)**

Parameter	Symbol	Value	Unit
Repetitive Peak Reverse Voltage	V <sub>R</sub>	40	V
RMS reverse voltage reverse voltage (DC)	V <sub>RMS</sub>	28	V
Forward Current	I <sub>F</sub>	500	mA
Non-Repetitive Peak Forward Surge Current @ t = 8.3 ms	I <sub>FSM</sub>	5.5	A
Power Dissipation	P <sub>D</sub>	200	mW
Thermal Resistance From Junction To Ambient	R <sub>θJA</sub>	500	°C/W
Junction Temperature	T <sub>J</sub>	125	°C
Storage Temperature	T <sub>STG</sub>	-55 ~+150	°C
Voltage rate of change	dv/dt	1000	V/μs

**ELECTRICAL CHARACTERISTICS (T<sub>A</sub> = 25°C unless otherwise specified)**

Parameter	Symbol	Min	Max	Unit	Conditions
Reverse breakdown voltage	V <sub>(BR)</sub>	40		V	I <sub>R</sub> =20uA
Forward voltage	V <sub>F</sub>		0.51	V	I <sub>F</sub> =0.5A
			0.62		I <sub>F</sub> =1A
Reverse voltage leakage current	I <sub>R</sub>		10	uA	V <sub>R</sub> =20V
			20		V <sub>R</sub> =40V
Diode capacitance	C <sub>D</sub>		170	pF	V <sub>R</sub> =0, f=1MHz

SCHOTTKY BARRIER DIODE

Typical Characteristics

**Forward Characteristics**

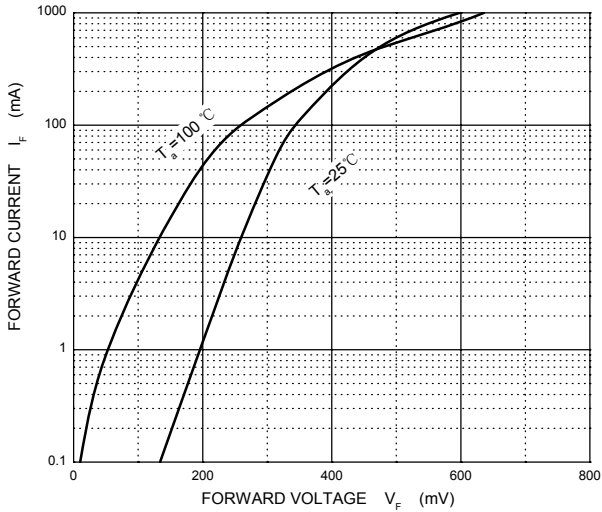

**Reverse Characteristics**

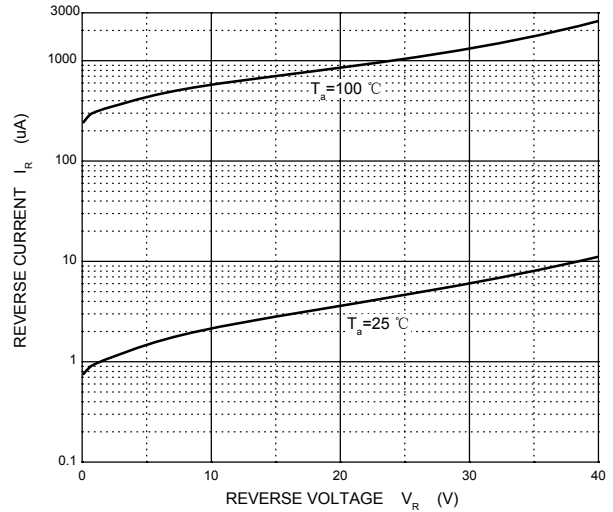

**Capacitance Characteristics**

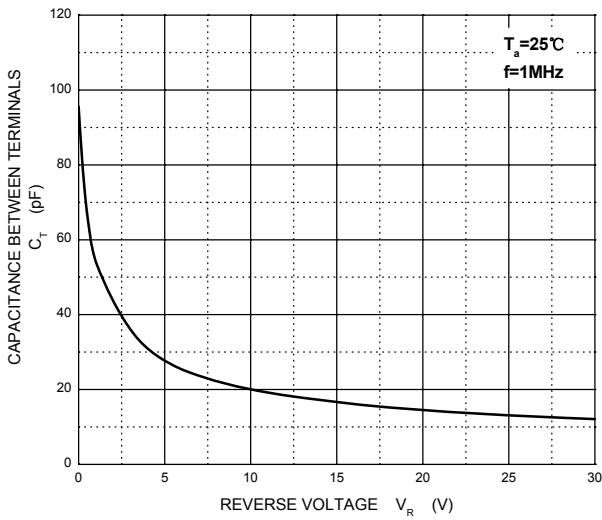

**Power Derating Curve**

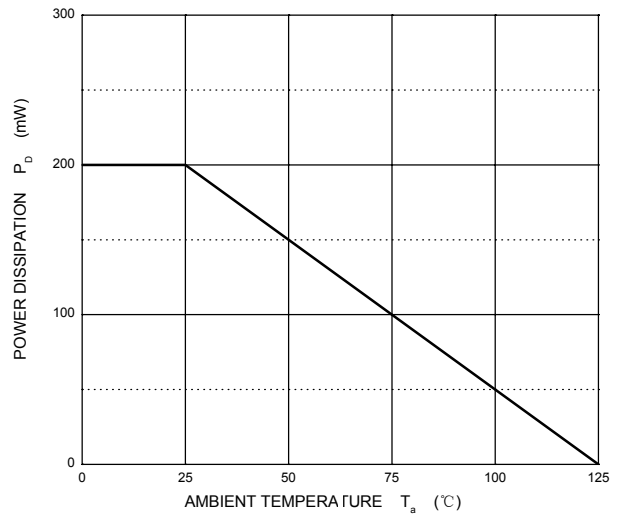

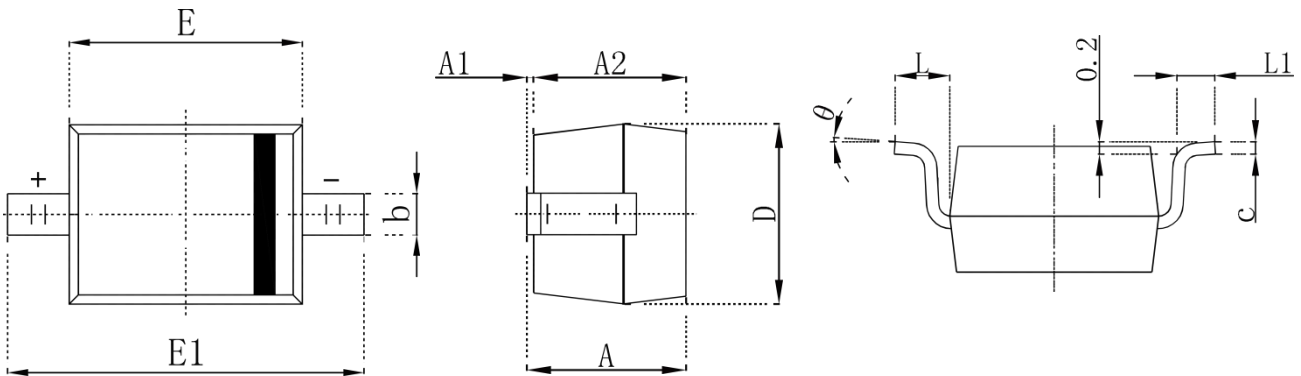
**SCHOTTKY BARRIER DIODE**
**SOD-323 Package Outline Dimensions**

Symbol	Dimensions In Millimeters		Dimensions In Inches	
	Min.	Max.	Min.	Max.
A		1.000		0.039
A1	0.000	0.100	0.000	0.004
A2	0.800	0.900	0.031	0.035
b	0.250	0.350	0.010	0.014
c	0.080	0.150	0.003	0.006
D	1.200	1.400	0.047	0.055
E	1.600	1.800	0.063	0.071
E1	2.250	2.750	0.100	0.108
L	0.475 REF		0.019 REF	
L1	0.250	0.400	0.010	0.016
$\theta$	0°	8°	0°	8°

**SOD-323 Suggested Pad Layout**

**Note:**

1. Controlling dimension: in millimeters
2. General tolerance:  $\pm 0.05\text{mm}$
3. The pad layout is for reference purposes only

SCHOTTKY BARRIER DIODE

**SOD-323 Tape and Reel**

**SOD-323 Embossed Carrier Tape**

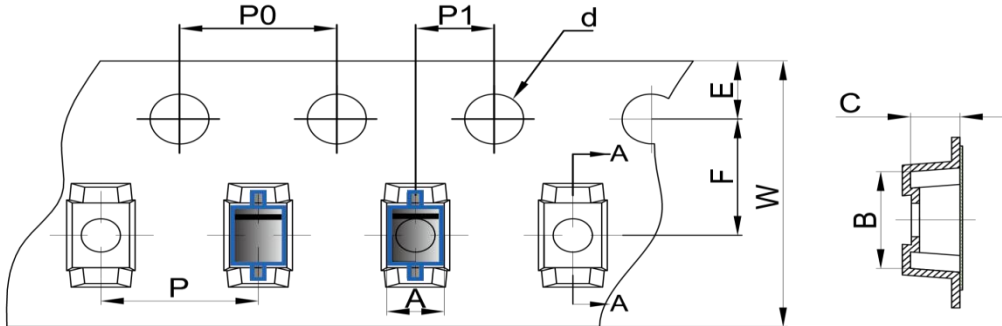

DIMENSIONS ARE IN MILLIMETER										
TYPE	A	B	C	d	E	F	P0	P	P1	W
SOD-323	1.48	3.3	1.25	Ø1.50	1.75	3.50	4.00	4.00	2.00	8.00
TOLERANCE	±0.1	±0.1	±0.1	±0.1	±0.1	±0.1	±0.1	±0.1	±0.1	±0.1

**SOD-323 Tape Leader and Trailer**

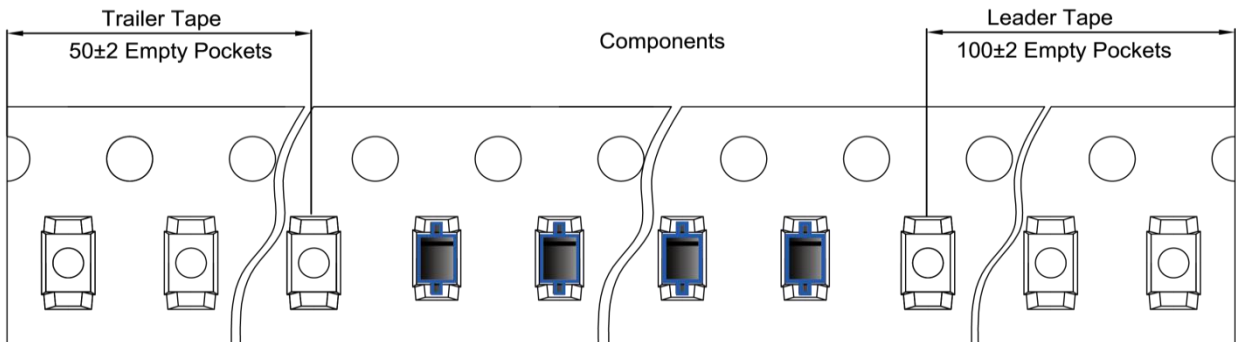

**SOD-323 Reel**

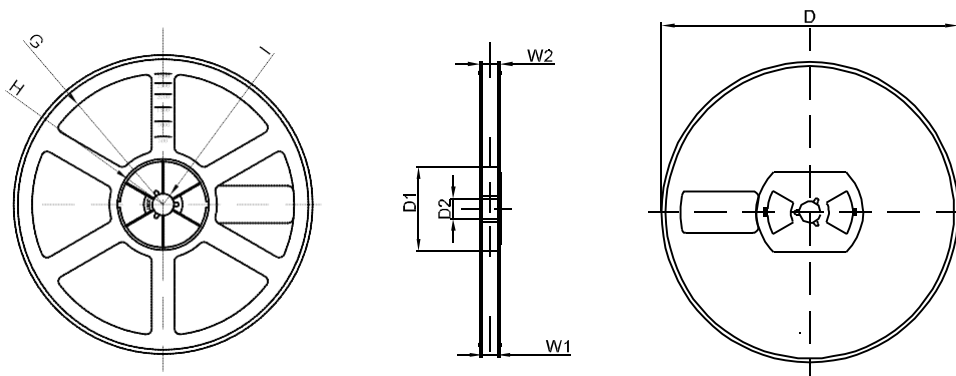

DIMENSIONS ARE IN MILLIMETER								
REEL OPTION	D	D1	D2	G	H	I	W1	W2
7" DIA	Ø178	54.40	13.00	R78	R25.60	R6.50	9.50	12.30
TOLERANCE	±2	±1	±1	±1	±1	±1	±1	±1