

3.0A SURFACE MOUNT SCHOTTKY BARRIER RECTIFIER

Features

- Small Surface Mount device
- Low power loss, high efficiency
- High forward surge current capability
- For use in low voltage, high frequency inverters, free wheeling, and polarity protection applications



SMA

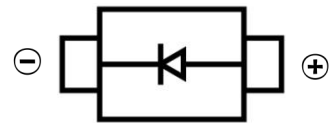

Mechanical Data

- Case: SMA(DO-214AC)
- Case Material: Molded Plastic. UL flammability
- Classification Rating: 94V-0
- Weight: 0.065 grams (approximate)
- Marking: SS12 SS13 SS14 SS15 SS16 SS18 SS110

Maximum Ratings and Electrical Characteristics @ $T_A = 25^\circ\text{C}$ unless otherwise specified

Single phase, half wave, 60Hz, resistive or inductive load.
For capacitive load, derate current by 20%.

Characteristic	Symbol	B320A	B330A	B340A	B350A	B360A	Unit	
Peak Repetitive Reverse Voltage	V_{RRM}							
Working Peak Reverse Voltage	V_{RWM}	20	30	40	50	60	V	
DC Blocking Voltage	V_R							
RMS Reverse Voltage	$V_{R(RMS)}$	14	21	28	35	42	V	
Average Rectified Output Current @ $T_T = 100^\circ\text{C}$	I_O	3.0						A
Non-Repetitive Peak Forward Surge Current 8.3ms single half sine-wave superimposed on rated load	I_{FSM}	60						A
Forward Voltage (Note 3) @ $I_F = 3.0\text{A}$	V_{FM}	0.50			0.70		V	
Peak Reverse Current @ $T_A = 25^\circ\text{C}$ at Rated DC Blocking Voltage (Note 3) @ $T_A = 100^\circ\text{C}$	I_{RM}	0.5			20		mA	
Typical Capacitance (Note 2)	C_T	200					pF	
Typical Thermal Resistance, Junction to Terminal	$R_{\theta JT}$	25					$^\circ\text{C/W}$	
Typical Thermal Resistance, Junction to Ambient (Note 1)	$R_{\theta JA}$	95					$^\circ\text{C/W}$	
Operating Temperature Range	T_j	-55 to +125					$^\circ\text{C}$	
Storage Temperature Range	T_{STG}	-55 to +150					$^\circ\text{C}$	

- Notes:
1. Thermal Resistance: Junction to terminal, unit mounted on glass epoxy substrate with 2x3mm copper pad
 2. Measured at 1.0MHz and applied reverse voltage of 4.0V DC.
 3. Short duration test pulse used to minimize self-heating effect.
 4. RoHS revision 13.2.2003. Glass and high temperature solder exemptions applied, see *EU Directive Annex Notes 5 and 7*.

SCHOTTKY BARRIER DIODE

Typical Characteristics

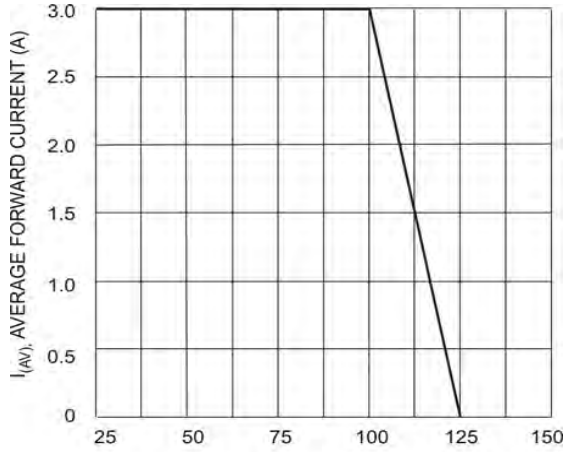

T_T, TERMINAL TEMPERATURE (°C)
Fig. 1 Forward Current Derating Curve

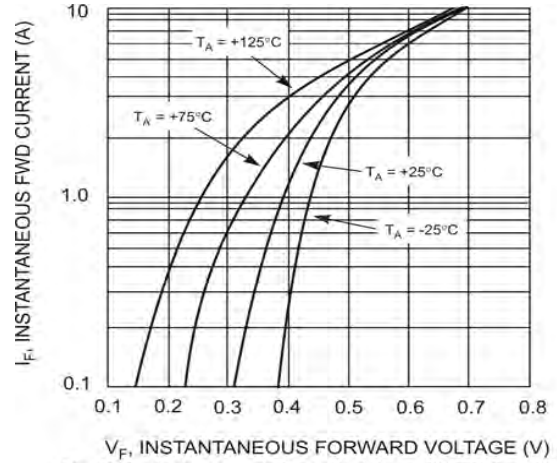

V_F, INSTANTANEOUS FORWARD VOLTAGE (V)
Fig. 2 Typical Forward Characteristics - B320B thru B340B

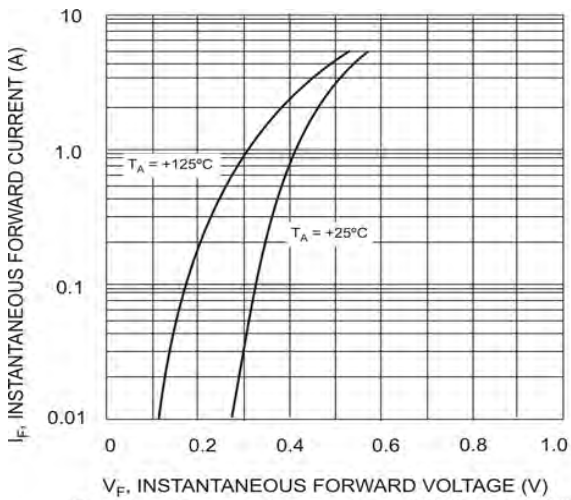

V_F, INSTANTANEOUS FORWARD VOLTAGE (V)
Fig. 3 Typ. Forward Characteristics - B350B thru B360B

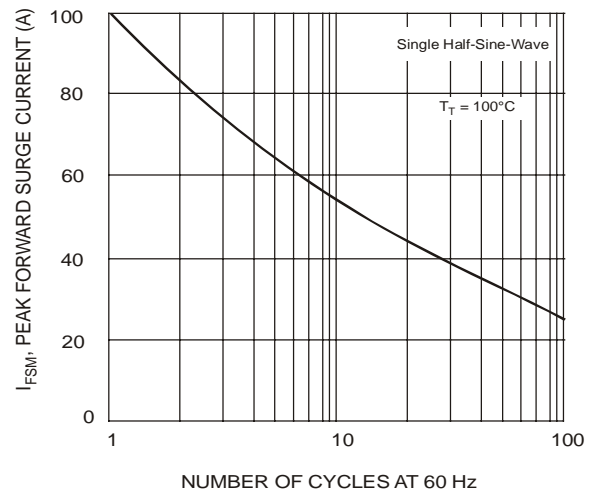

NUMBER OF CYCLES AT 60 Hz
Fig. 4 Max Non-Repetitive Peak Forward Surge Current

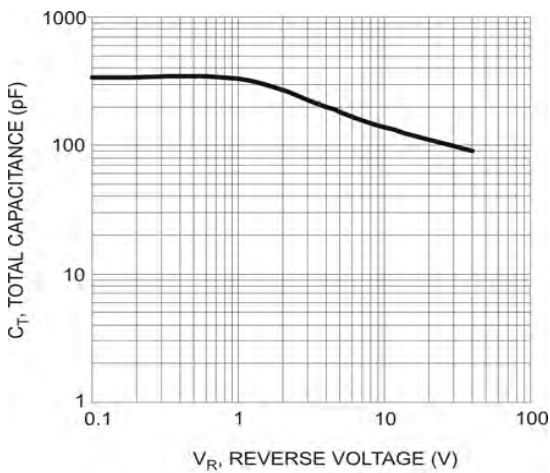

V_R, REVERSE VOLTAGE (V)
Fig. 5 Typical Capacitance

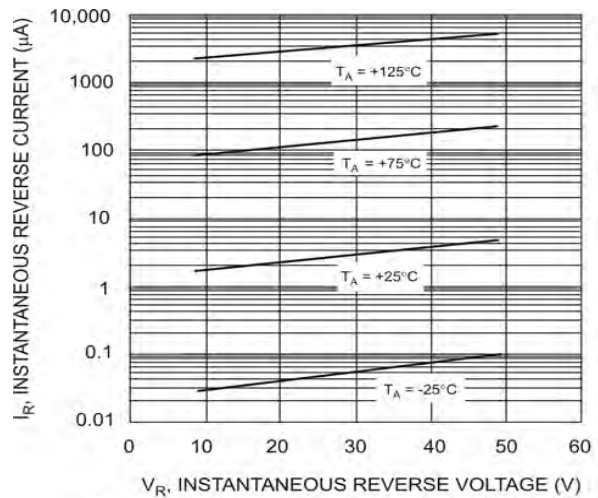

V_R, INSTANTANEOUS REVERSE VOLTAGE (V)
Fig. 6 Typical Reverse Characteristics, B320B thru B340B

SCHOTTKY BARRIER DIODE

SMA Package Outline Dimensions

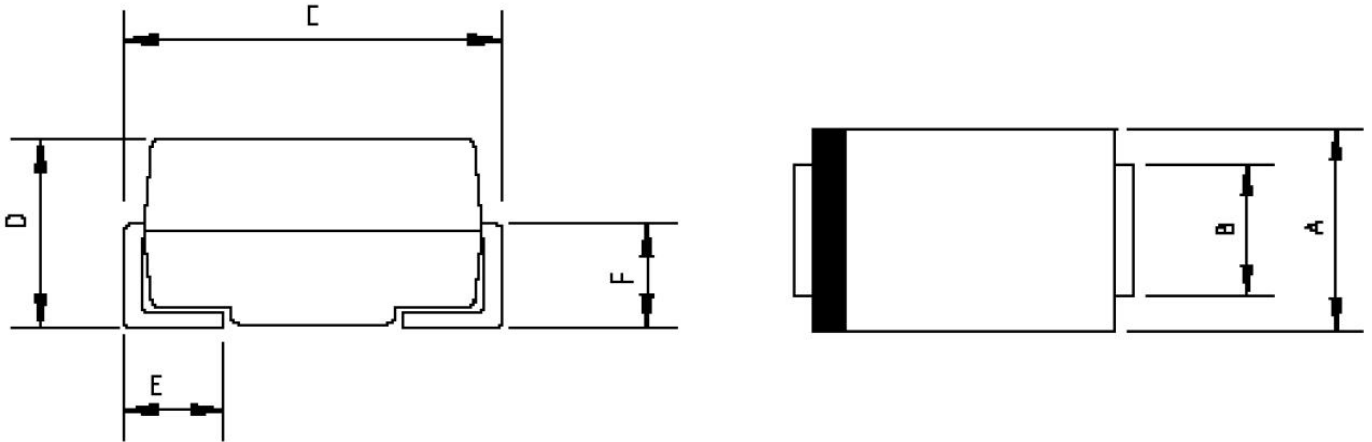

Symbol	Dimensions In Millimeters		Dimensions In Inches	
	Min.	Max.	Min.	Max.
A	2.20	2.80	0.086	0.110
B	1.30	1.70	0.051	0.067
C	4.70	5.30	0.185	0.209
D	1.70	2.55	0.067	0.100
E	0.90	1.50	0.035	0.059
F	0.90	1.50	0.035	0.059

SMA Suggested Pad Layout

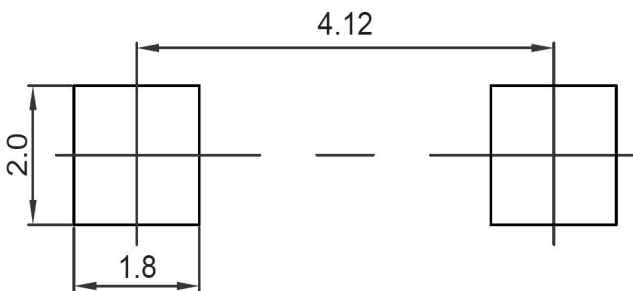

Note:

1. Controlling dimension: in millimeters
2. General tolerance: $\pm 0.05\text{mm}$
3. The pad layout is for reference purposes only

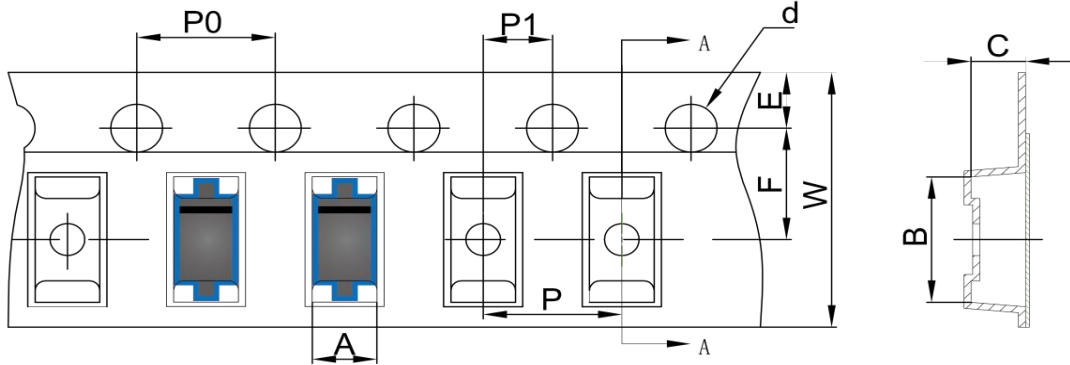
SCHOTTKY BARRIER DIODE
SMA Tape and Reel
SMA Embossed Carrier Tape

DIMENSIONS ARE IN MILLIMETER										
TYPE	A	B	C	d	E	F	P0	P	P1	W
SMA	2.89	5.35	2.68	Ø1.50	1.75	5.50	4.00	4.00	2.00	12.00
TOLERANCE	±0.1	±0.1	±0.1	±0.1	±0.1	±0.1	±0.1	±0.1	±0.1	±0.1

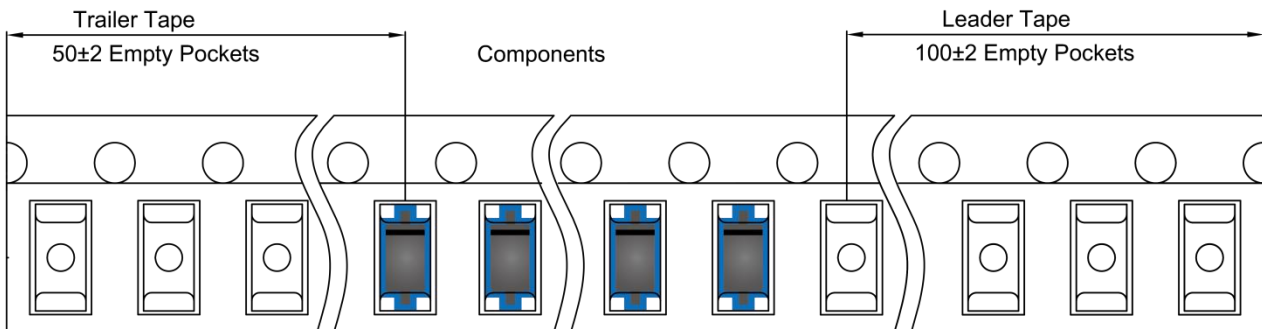
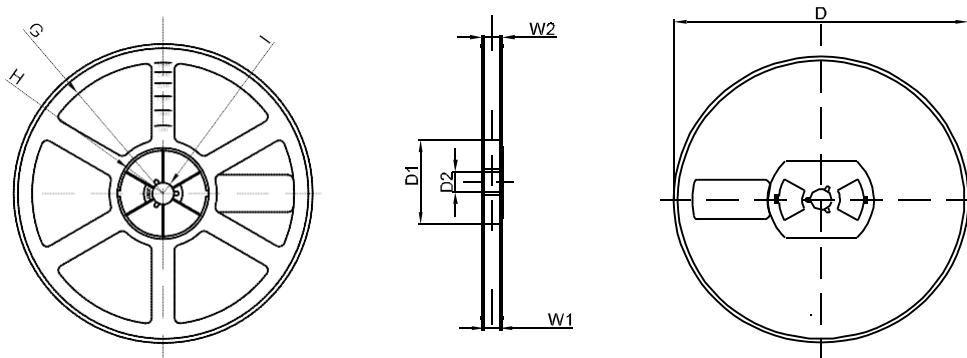
SMA Tape Leader and Trailer

SMA Reel

DIMENSIONS ARE IN MILLIMETER								
REEL OPTION	D	D1	D2	G	H	I	W1	W2
7" DIA	Ø178	54.40	13.00	R78	R25.60	R6.50	12.40	17.60
TOLERANCE	±2	±1	±1	±1	±1	±1	±1	±1