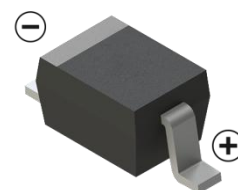
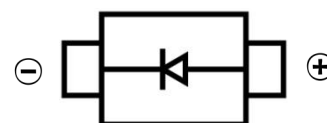

SWITCHING DIODE
FEATURES

- High Switching time:Max. 4 ns
- Continuous reverse voltage: max. 75V
- Repetitive peak reverse voltage: max. 100V
- Repetitive peak forward current: max. 500mA
- Surface Mount device
- For High-speed Switching Applications

SOD-323

MECHANICAL DATA

- Case: SOD-323
- Case Material: Molded Plastic. UL flammability
- Classification Rating: 94V-0
- Weight: 0.008 grams (approximate)

MARKING: A6
MAXIMUM RATINGS (T_A = 25°C unless otherwise noted)

Parameter	Symbol	Value	Unit
Repetitive Peak Reverse Voltage	V _{RRM}	100	V
Continuous Reverse Voltage	V _R	75	V
RMS Reverse Voltage	V _{RMS}	53	V
Forward Current	I _F	250	mA
Repetitive peak forward current	I _{FRM}	500	mA
Non-Repetitive Peak Forward Surge Current (square wave; T _J =25°C)	t= 1μs	5	A
	t=1ms	1	
	t=1s	0.5	
Power Dissipation	P _D	200	mW
Thermal Resistance From Junction To Ambient	R _{θJA}	625	°C/W
Junction Temperature	T _J	150	°C
Storage Temperature	T _{STG}	-55 ~+150	°C

ELECTRICAL CHARACTERISTICS (T_A = 25°C unless otherwise specified)

Parameter	Symbol	Typ.	Max	Unit	Conditions
Forward voltage	V _F		0.715	V	I _F =1mA
			0.855		I _F =10mA
			1.0		I _F =50mA
			1.25		I _F =150mA
Reverse voltage leakage current	I _R		30	nA	V _R =25V
			1	μA	V _R =75V
			30		V _R =25V, T _J =150°C
			50		V _R =75V, T _J =150°C
Diode capacitance	C _D		2	pF	V _R =0V, f=1MHz
Reverse recovery time	T _{rr}		4	ns	I _F =I _R =10mA I _{rr} =0.1×I _R R _L =100Ω
Forward recovery voltage	V _{fr}		1.75	V	I _F =10mA, t _r =20ns

SWITCHING DIODE

Typical Characteristics

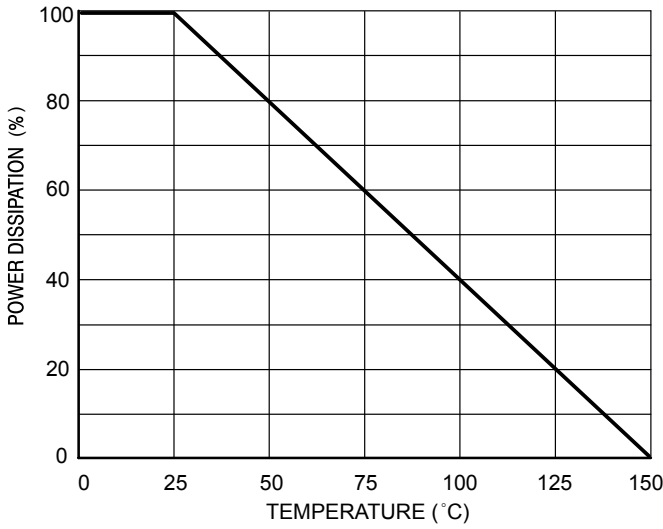

Fig.1 Steady State Power Derating

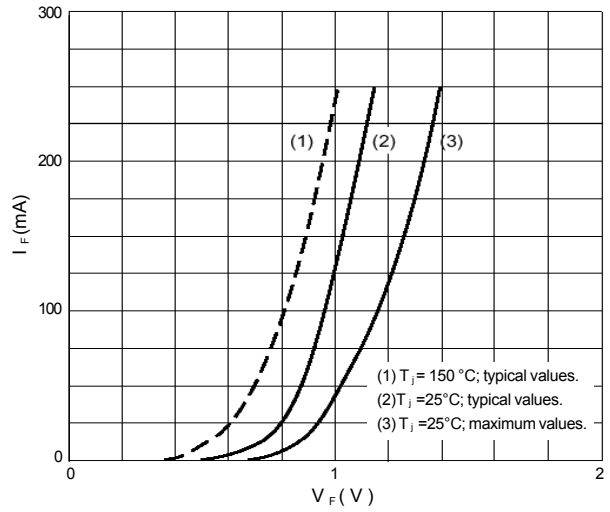

Fig.2 Forward current as a function of forward voltage.

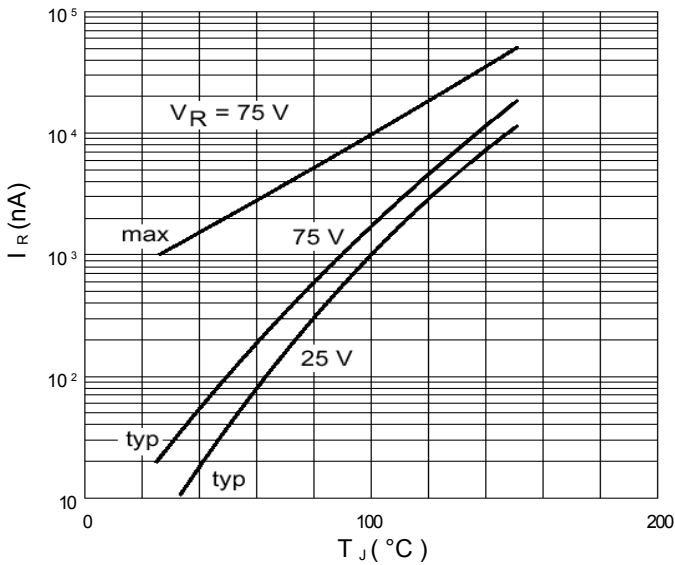

Fig.3 Reverse current as a function of junction temperature.

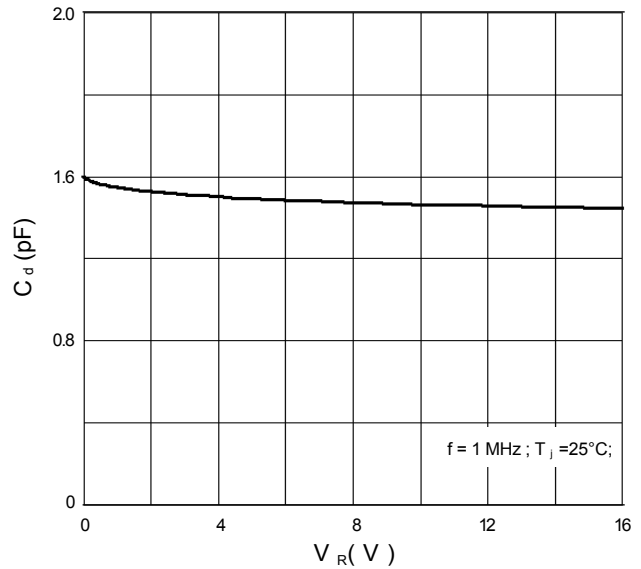

Fig.4 Diode capacitance as a function of reverse voltage; typical values.

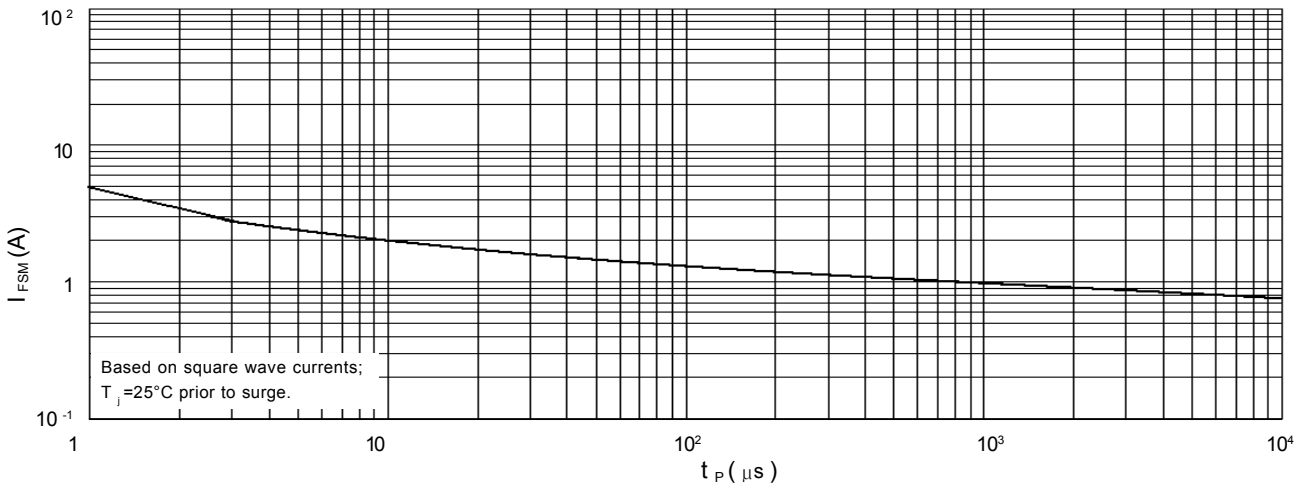
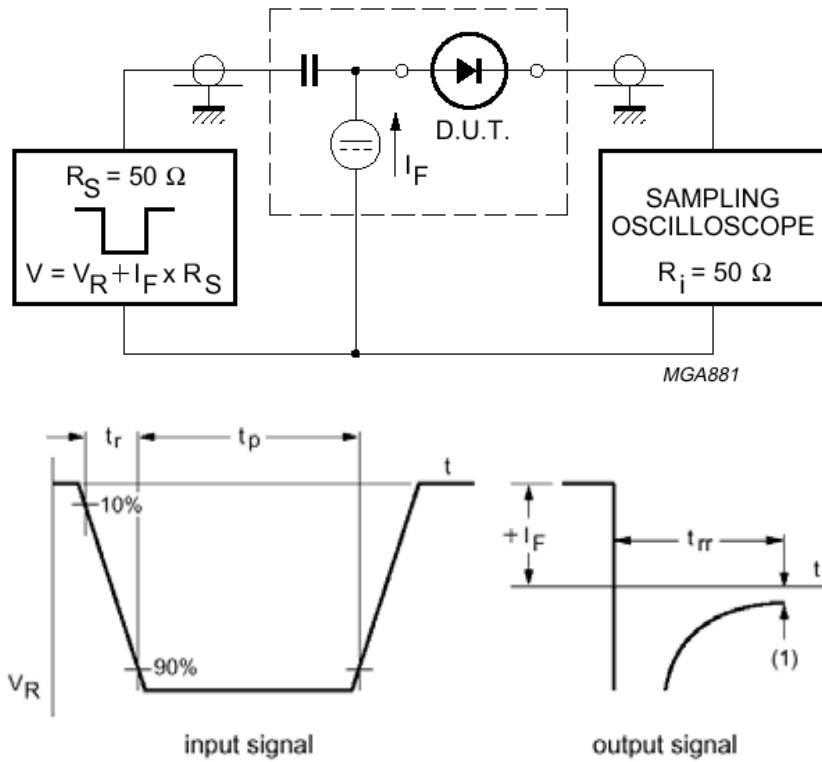

Fig.5 Maximum permissible non-repetitive peak forward current as a function of pulse duration.

SWITCHING DIODE



(1) $I_R = 1 \text{ mA}$.

Input signal: reverse pulse rise time $t_r = 0.6 \text{ ns}$; reverse voltage pulse duration $t_p = 100 \text{ ns}$; duty factor $\delta \approx 0.05$;

Oscilloscope: rise time $t_r = 0.35 \text{ ns}$.

Fig.6 Reverse recovery voltage test circuit and waveforms.

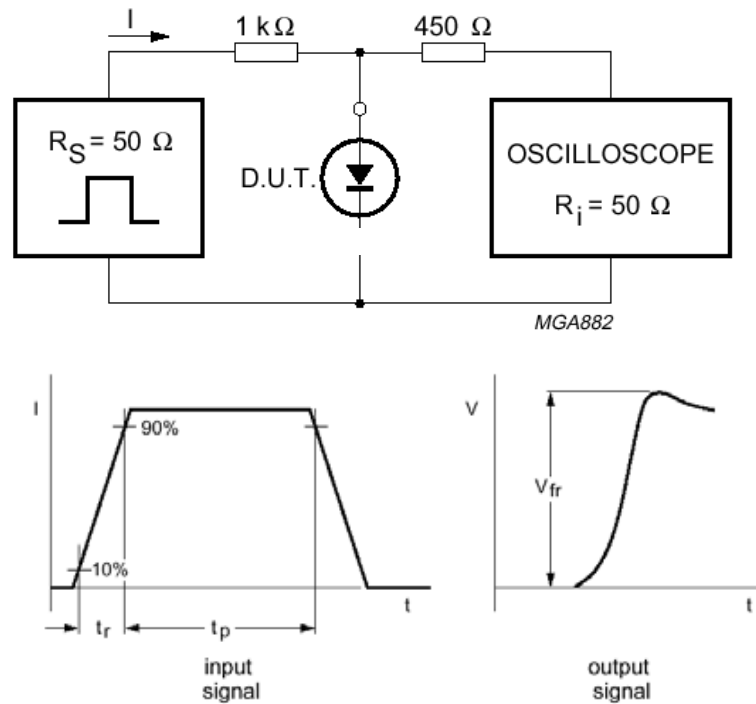

Input signal: forward pulse rise time $t_r = 20 \text{ ns}$; forward current pulse duration $t_p \geq 100 \text{ ns}$; duty factor $\delta \leq 0.005$.

Fig.7 Forward recovery voltage test circuit and waveforms.

SOD-323 Package Outline Dimensions

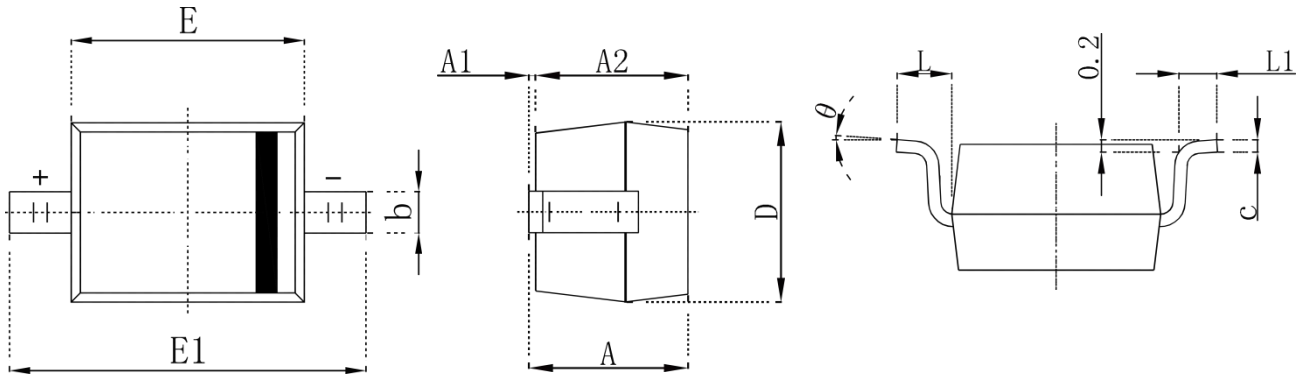

Symbol	Dimensions In Millimeters		Dimensions In Inches	
	Min.	Max.	Min.	Max.
A		1.000		0.039
A1	0.000	0.100	0.000	0.004
A2	0.800	0.900	0.031	0.035
b	0.250	0.350	0.010	0.014
c	0.080	0.150	0.003	0.006
D	1.200	1.400	0.047	0.055
E	1.600	1.800	0.063	0.071
E1	2.250	2.750	0.100	0.108
L	0.475 REF		0.019 REF	
L1	0.250	0.400	0.010	0.016
θ	0°	8°	0°	8°

SOD-323 Suggested Pad Layout

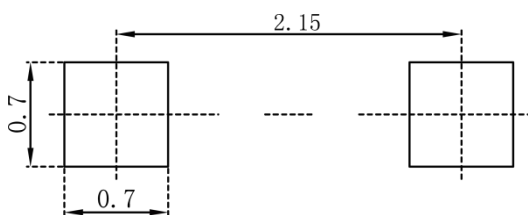

Note:

1. Controlling dimension: in millimeters
2. General tolerance: ±0.05mm
3. The pad layout is for reference purposes only

SOD-323 Tape and Reel

SOD-323 Embossed Carrier Tape

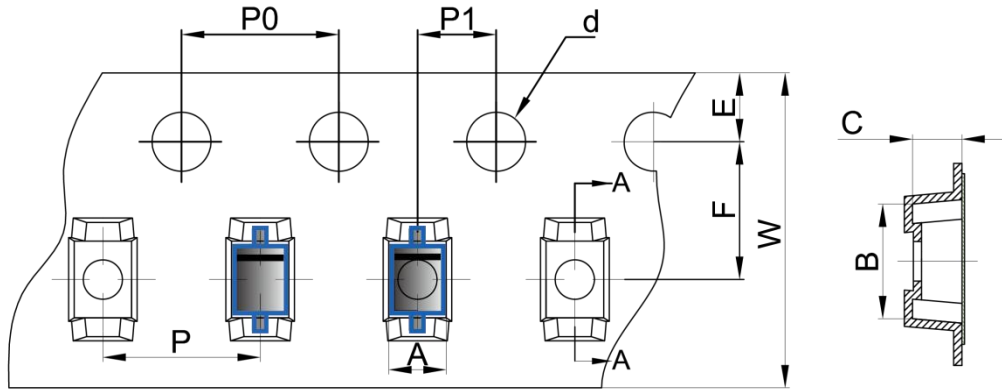

DIMENSIONS ARE IN MILLIMETER										
TYPE	A	B	C	d	E	F	P0	P	P1	W
SOD-323	1.48	3.3	1.25	Ø1.50	1.75	3.50	4.00	4.00	2.00	8.00
TOLERANCE	±0.1	±0.1	±0.1	±0.1	±0.1	±0.1	±0.1	±0.1	±0.1	±0.1

SOD-323 Tape Leader and Trailer

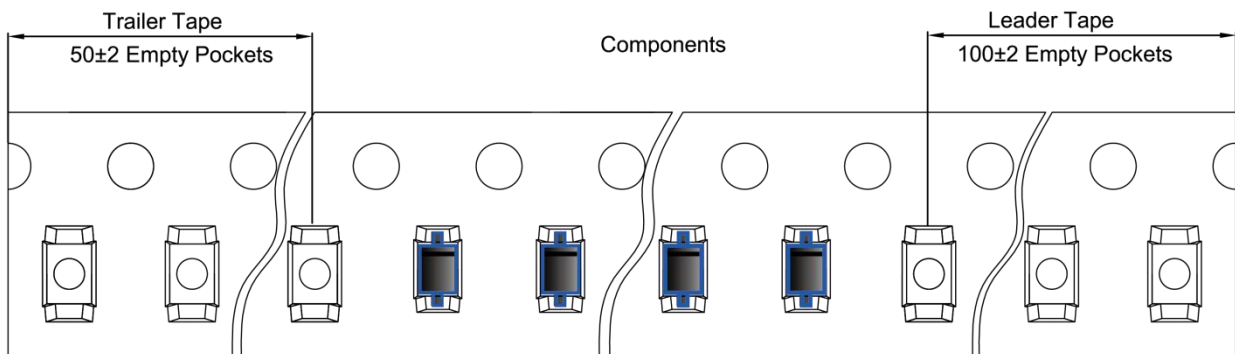

SOD-323 Reel

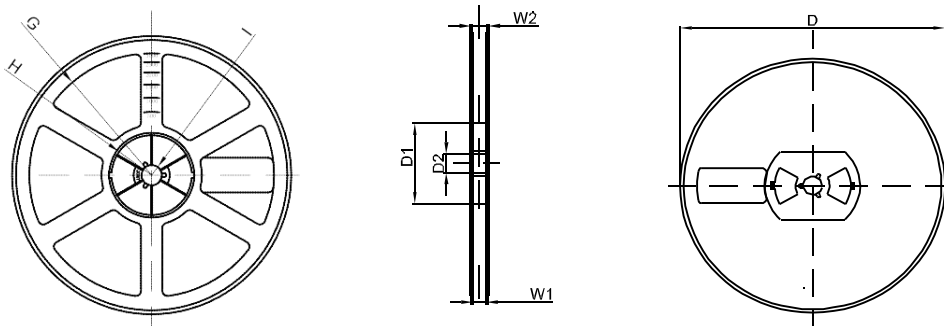

DIMENSIONS ARE IN MILLIMETER								
REEL OPTION	D	D1	D2	G	H	I	W1	W2
7" DIA	Ø178	54.40	13.00	R78	R25.60	R6.50	9.50	12.30
TOLERANCE	±2	±1	±1	±1	±1	±1	±1	±1