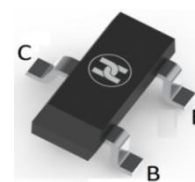
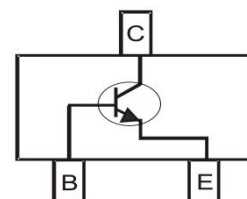

**BIPOLAR TRANSISTOR (NPN)**
**FEATURES**

- Complementary to MMBT2907
- General purpose Amplifier
- Surface Mount device

**SOT-23**
**MECHANICAL DATA**

- Case: SOT-23
- Case Material: Molded Plastic. UL flammability
- Classification Rating: 94V-0
- Weight: 0.008 grams (approximate)

**MAXIMUM RATINGS (T<sub>A</sub> = 25°C unless otherwise noted)**

Parameter	Symbol	Value	Unit
Collector-Base Voltage	V <sub>CB0</sub>	75	V
Collector-Emitter Voltage	V <sub>CEO</sub>	30	V
Emitter-Base Voltage	V <sub>EBO</sub>	6	V
Collector Current	I <sub>C</sub>	600	mA
Collector Power Dissipation	P <sub>C</sub>	250	mW
Thermal Resistance From Junction To Ambient	R <sub>θJA</sub>	500	°C/W
Junction Temperature	T <sub>J</sub>	150	°C
Storage Temperature	T <sub>STG</sub>	-55 ~+150	°C

**ELECTRICAL CHARACTERISTICS (T<sub>A</sub> = 25°C unless otherwise specified)**

Parameter	Symbol	Min	Typ	Max	Unit	Conditions
Collector-base breakdown voltage	V <sub>(BR)CBO</sub>	75			V	I <sub>C</sub> =10μA, I <sub>E</sub> =0
Collector-emitter breakdown voltage	V <sub>(BR)CEO</sub>	30			V	I <sub>C</sub> =10mA, I <sub>B</sub> =0
Emitter-base breakdown voltage	V <sub>(BR)EBO</sub>	6			V	I <sub>E</sub> =10μA, I <sub>C</sub> =0
Collector cut-off current	I <sub>CBO</sub>			0.01	μA	V <sub>CB</sub> =60V, I <sub>E</sub> =0
Collector cut-off current	I <sub>CEX</sub>			0.01	μA	V <sub>CE</sub> =30V, V <sub>BE(OFF)</sub> =3V
Emitter cut-off current	I <sub>EBO</sub>			0.1	μA	V <sub>EB</sub> =3V, I <sub>C</sub> =0
DC current gain	h <sub>FE1</sub>	100		300		V <sub>CE</sub> =10V, I <sub>C</sub> =150mA
	h <sub>FE2</sub>	40				V <sub>CE</sub> =10V, I <sub>C</sub> =0.1mA
	h <sub>FE3</sub>	42				V <sub>CE</sub> =10V, I <sub>C</sub> =500mA
Collector-emitter saturation voltage	V <sub>CE(sat)</sub>			1	V	I <sub>C</sub> =500mA, I <sub>B</sub> =50mA
	V <sub>CE(sat)</sub>			0.3	V	I <sub>C</sub> =150mA, I <sub>B</sub> =15mA
Base-emitter saturation voltage	V <sub>BE(sat)</sub>			1.2	V	I <sub>C</sub> =500mA, I <sub>B</sub> =50mA
Transition frequency	f <sub>T</sub>	300			MHz	V <sub>CE</sub> =20V, I <sub>C</sub> =20mA, f=100MHz
Delay time	t <sub>d</sub>			10	ns	V <sub>CC</sub> =30V, V <sub>BE(OFF)</sub> =0.5V, I <sub>C</sub> =150mA, I <sub>B1</sub> =15mA
Rise time	t <sub>r</sub>			25	ns	I <sub>C</sub> =150mA, I <sub>B1</sub> =15mA
Storage time	t <sub>s</sub>			225	ns	V <sub>CC</sub> =30V, I <sub>C</sub> =150mA
Fall time	t <sub>f</sub>			60	ns	I <sub>B1</sub> =I <sub>B2</sub> =15mA

**CLASSIFICATION OF h<sub>FE</sub>**

Rank	L	H
Range	100-200	200-300
Marking	M1B	M1B

**BIPOLAR TRANSISTOR (NPN)**

**Typical Characteristics**

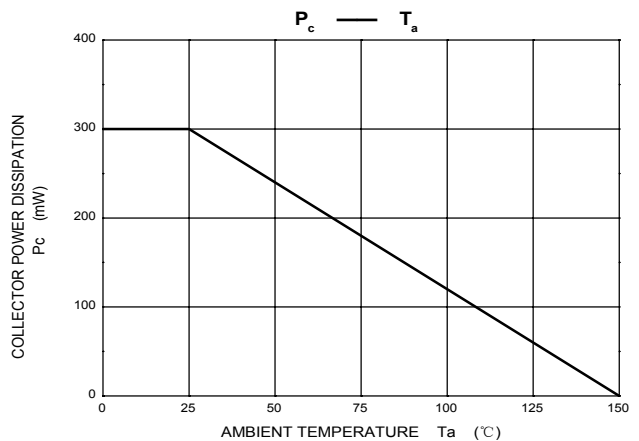
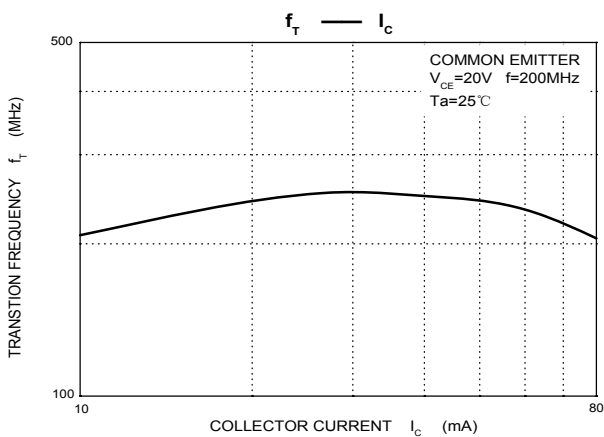
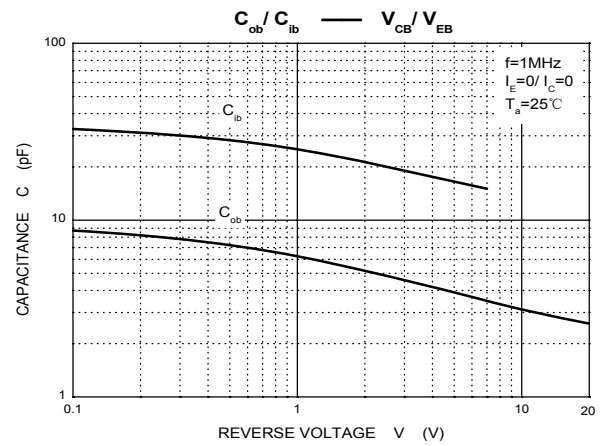
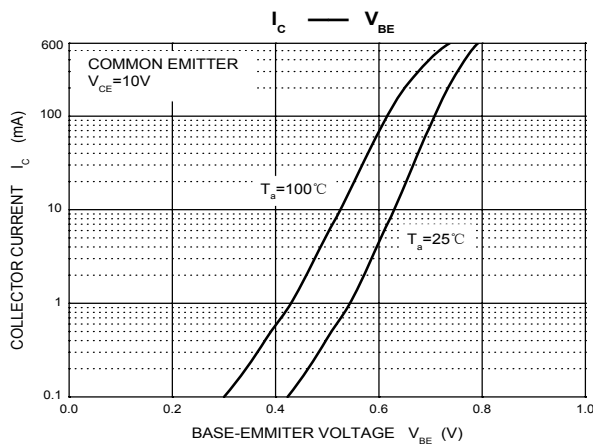
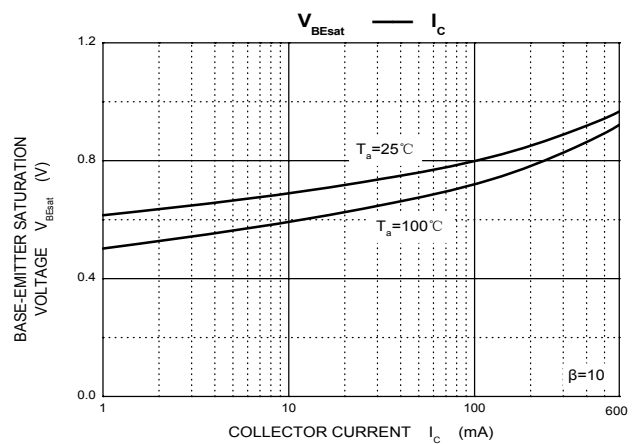
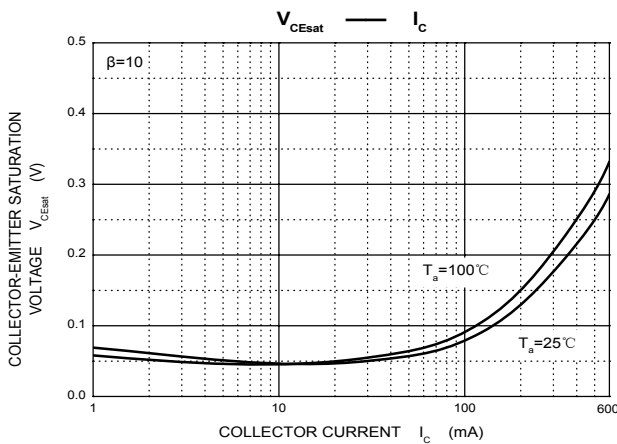
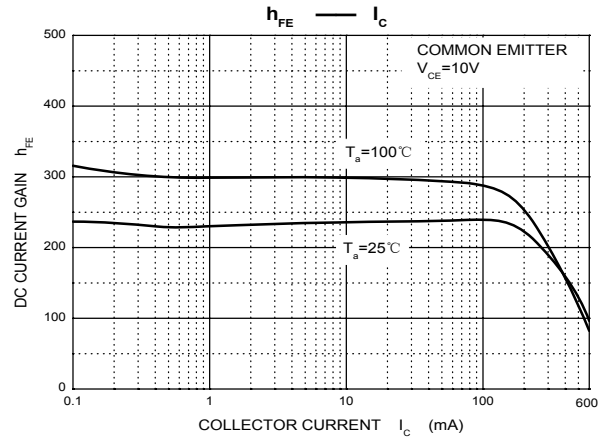
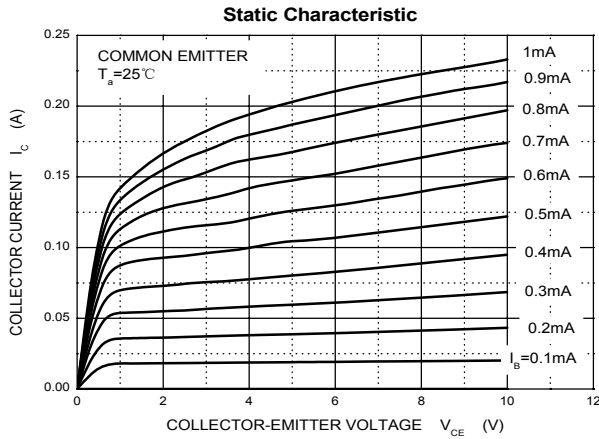

**BIPOLAR TRANSISTOR (NPN)**
**SOT-23 Package Outline Dimensions**

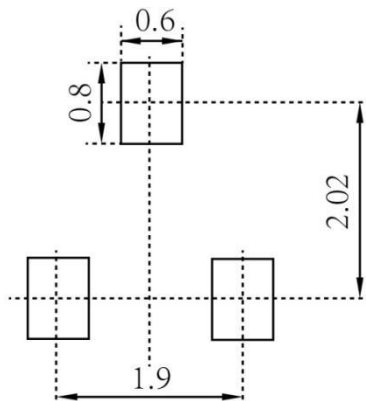

Symbol	Dimensions In Millimeters		Dimensions In Inches	
	Min.	Max.	Min.	Max.
A	0.900	1.150	0.035	0.045
A1	0.000	0.100	0.000	0.004
A2	0.900	1.050	0.035	0.041
b	0.300	0.500	0.012	0.020
c	0.080	0.150	0.003	0.006
D	2.800	3.000	0.110	0.118
E	1.200	1.400	0.047	0.055
E1	2.250	2.550	0.089	0.100
e	0.950 TYP		0.037 TYP	
e1	1.800	2.000	0.071	0.079
L	0.550 REF		0.022 REF	
L1	0.300	0.500	0.012	0.020
θ	0°	8°	0°	8°

**SOT-23 Suggested Pad Layout**

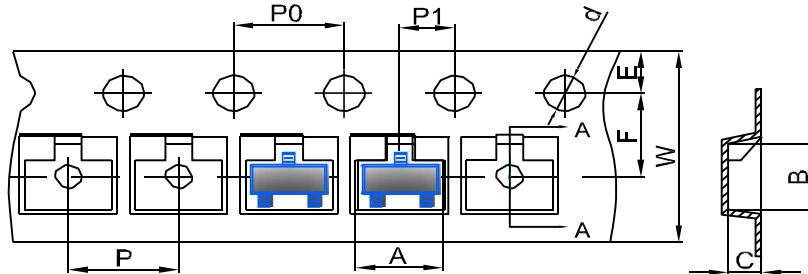
**Note:**

1. Controlling dimension: in millimeters
2. General tolerance:  $\pm 0.05\text{mm}$
3. The pad layout is for reference purposes only

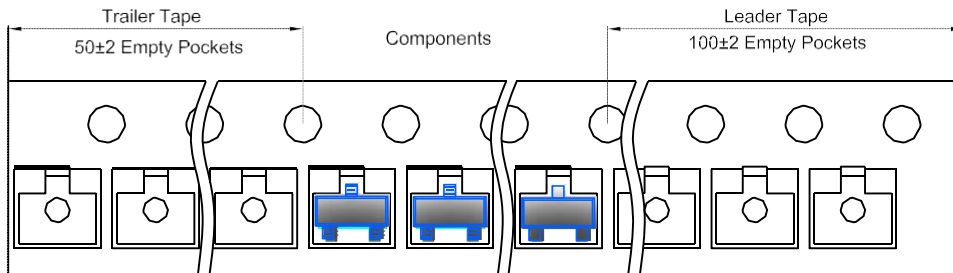
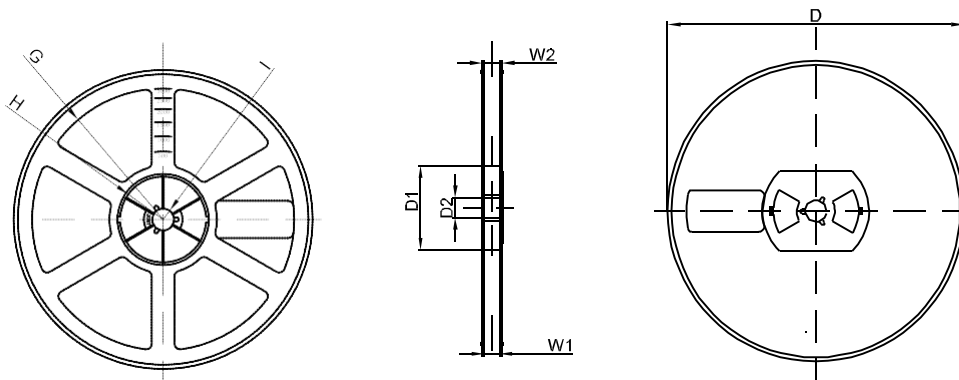
**BIPOLAR TRANSISTOR (NPN)**
**SOT-23 Tape and Reel**
**SOT-23 Embossed Carrier Tape**

DIMENSIONS ARE IN MILLIMETER										
TYPE	A	B	C	d	E	F	P0	P	P1	W
SOT-23	3.15	2.77	1.22	Ø1.50	1.75	3.50	4.00	4.00	2.00	8.00
TOLERANCE	±0.1	±0.1	±0.1	±0.1	±0.1	±0.1	±0.1	±0.1	±0.1	±0.1

**SOT-23 Tape Leader and Trailer**

**SOT-23 Reel**

DIMENSIONS ARE IN MILLIMETER								
REEL OPTION	D	D1	D2	G	H	I	W1	W2
7" DIA	Ø178	54.40	13.00	R78	R25.60	R6.50	9.50	12.30
TOLERANCE	±2	±1	±1	±1	±1	±1	±1	±1