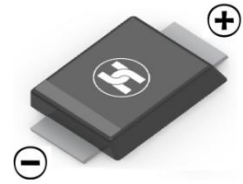
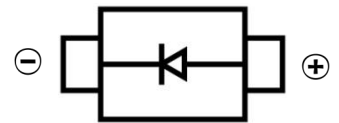

**FAST RECOVERY RECTIFIER DIODE**
**FEATURES**

- Surface Mount device
- Low Reverse voltage leakage current
- Glass passivated junction
- High forward surge current capability
- Low forward voltage drop

**SMBF**
**MECHANICAL DATA**

- Case: SMBF
- Case Material: Molded Plastic. UL flammability
- Classification Rating: 94V-0
- Weight: 0.057 grams (approximate)

**MAXIMUM RATINGS (T<sub>A</sub> = 25°C unless otherwise noted)**

Parameter	Symbol	Value	Unit
Maximum Recurrent Peak Reverse Voltage	V <sub>RRM</sub>	100	V
DC Blocking Reverse Voltage	V <sub>R</sub>	100	V
RMS Reverse Voltage	V <sub>R(RMS)</sub>	70	V
Maximum Average Forward Rectified Current	I <sub>F</sub>	1	A
Non-Repetitive Peak Forward Surge Current @t@=8.3ms	I <sub>FSM</sub>	30	A
Thermal Resistance From Junction To Ambient	R <sub>θJA</sub>	75	°C/W
Reverse Recovery Time(@I <sub>F</sub> =0.5A, I <sub>R</sub> =1.0A, I <sub>RR</sub> =0.25A)	t <sub>rr</sub>	150	nS
Junction Temperature	T <sub>J</sub>	-55 ~+150	°C
Storage Temperature	T <sub>STG</sub>	-55 ~+150	°C

**ELECTRICAL CHARACTERISTICS (T<sub>A</sub> = 25°C unless otherwise specified)**

Parameter	Symbol	Min	Typ	Max	Unit	Conditions
Forward voltage	V <sub>F</sub>			1.3	V	I <sub>F</sub> =1A
Reverse current	I <sub>R</sub>			5	uA	V <sub>R</sub> =100V
Diode capacitance	C <sub>D</sub>		15		pF	V <sub>R</sub> =4V <sub>DC</sub> ,f=1MHZ

**FAST RECOVERY RECTIFIER DIODE**

**Typical Characteristics**

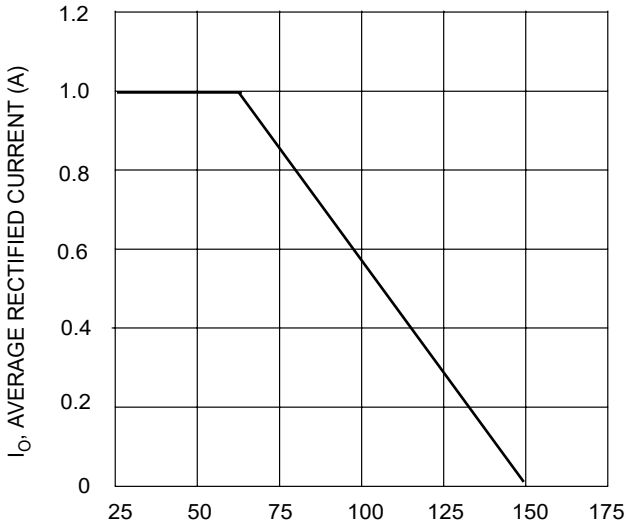

$T_T$ , TERMINAL TEMPERATURE (°C)  
Fig. 1 Forward Current Derating Curve

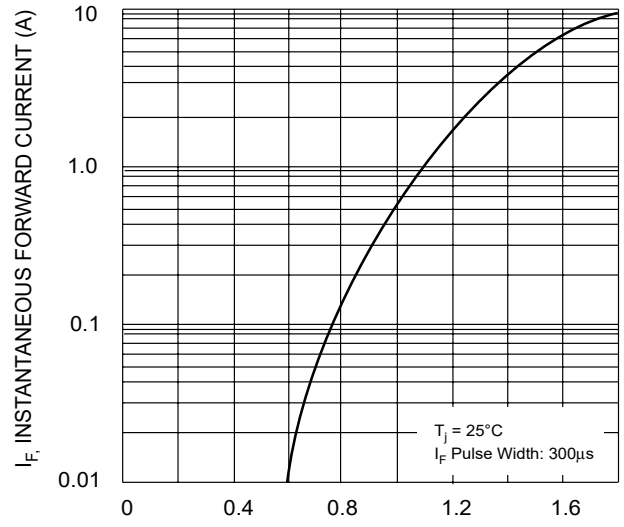

$V_F$ , INSTANTANEOUS FORWARD VOLTAGE (V)  
Fig. 2 Typical Forward Characteristics

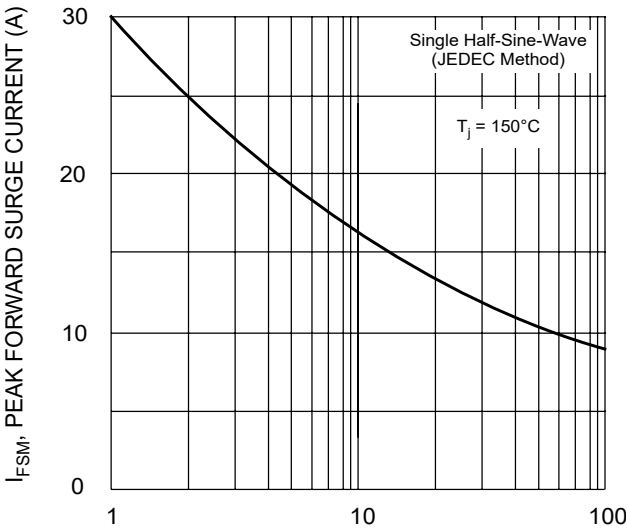

Fig. 3 Forward Surge Current Derating Curve

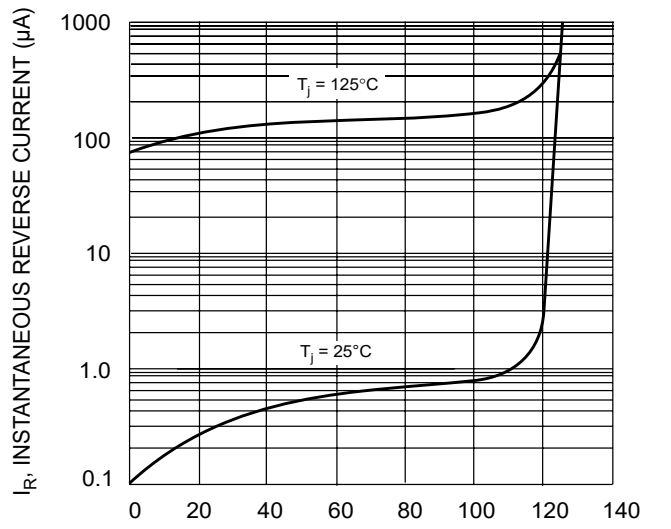
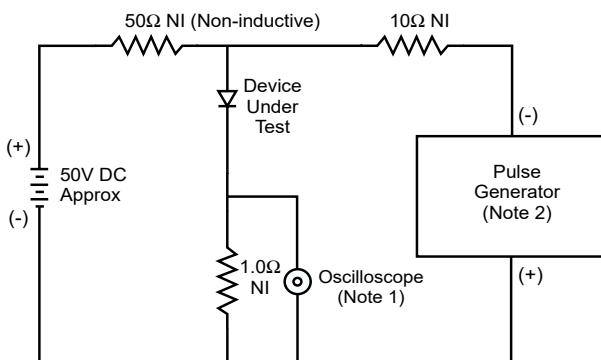
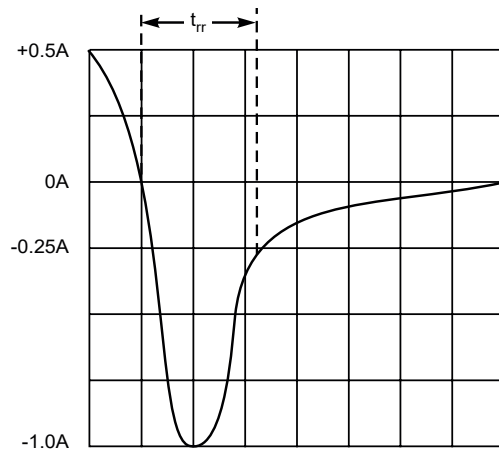

Fig. 4 Typical Reverse Characteristics



- Notes:  
 1. Rise Time = 7.0ns max. Input Impedance = 1.0MΩ, 22pF.  
 2. Rise Time = 10ns max. Input Impedance = 50Ω.



Set time base for 50/100 ns/cm

Fig. 5 Reverse Recovery Time Characteristic and Test Circuit

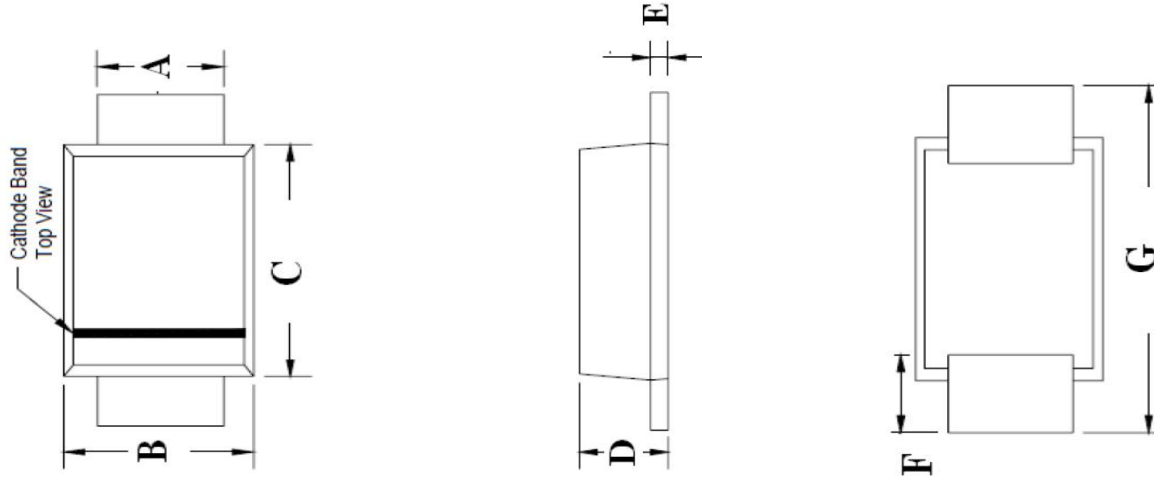
**FAST RECOVERY RECTIFIER DIODE**
**SMBF Package Outline Dimensions**

Symbol	Dimensions In Millimeters		Dimensions In Inches	
	Min.	Max.	Min.	Max.
A	1.90	2.20	0.075	0.086
B	3.50	3.70	0.094	0.110
C	4.20	4.40	0.165	0.173
D	1.10	1.40	0.043	0.055
E	0.15	0.25	0.006	0.010
F	0.95	1.05	0.038	0.041
G	5.10	5.50	0.200	0.216

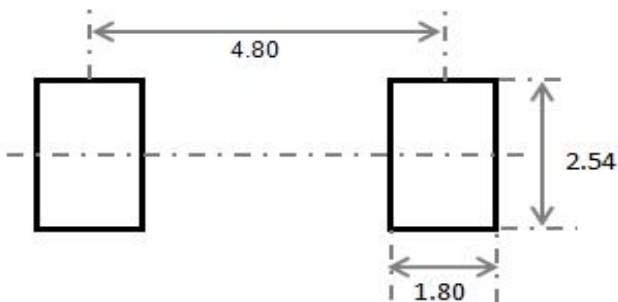
**SMBF Suggested Pad Layout**

**Note:**

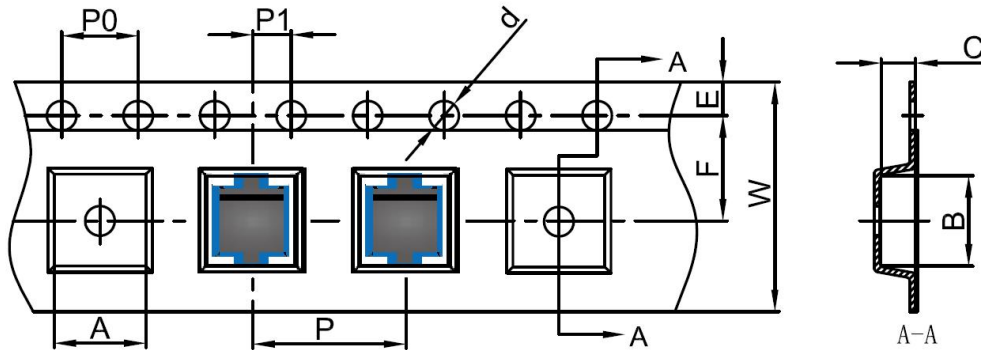
1. Controlling dimension: in millimeters
2. General tolerance:  $\pm 0.05\text{mm}$
3. The pad layout is for reference purposes only

**FAST RECOVERY RECTIFIER DIODE**
**SMBF Tape and Reel**
**SMBF Embossed Carrier Tape**

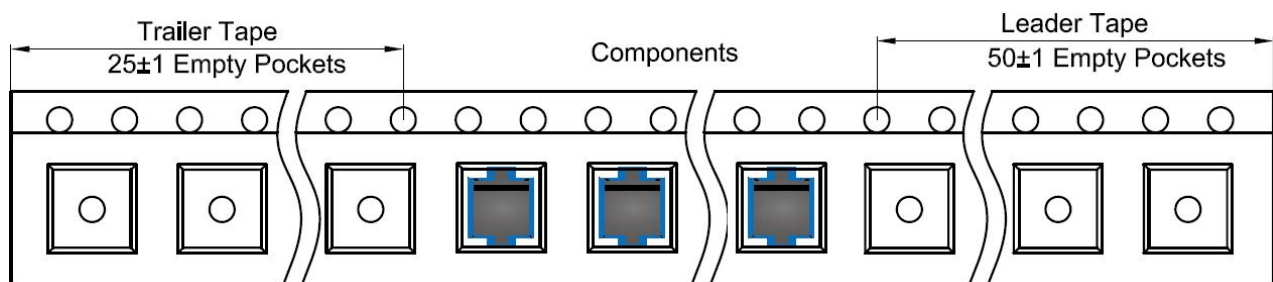
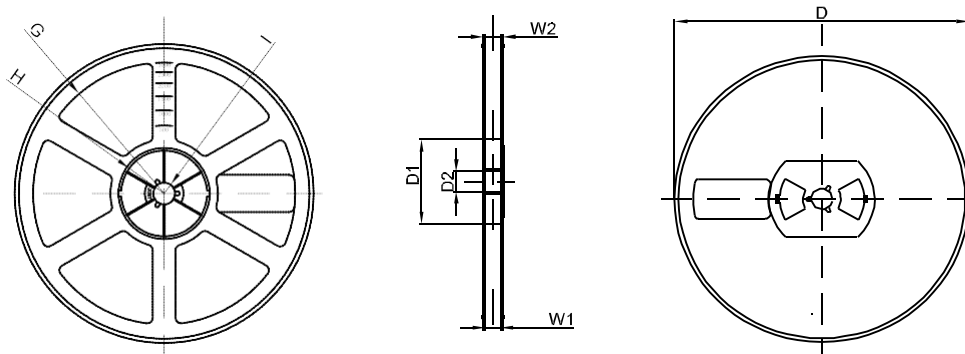
DIMENSIONS ARE IN MILLIMETER										
TYPE	A	B	C	d	E	F	P0	P	P1	W
SMBF	3.80	5.65	1.48	Ø1.50	1.75	5.50	4.00	8.00	2.00	12.00
TOLERANCE	±0.1	±0.1	±0.1	±0.1	±0.1	±0.1	±0.1	±0.1	±0.1	±0.1

**SMBF Tape Leader and Trailer**

**SMBF Reel**

DIMENSIONS ARE IN MILLIMETER								
REEL OPTION	D	D1	D2	G	H	I	W1	W2
13" DIA	Ø330	75.0	13.00	R165	R37.50	R6.50	12.40	17.60
TOLERANCE	±2	±1	±1	±1	±1	±1	±1	±1