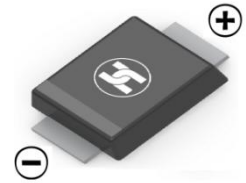
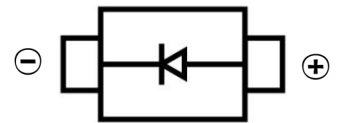

FAST RECOVERY RECTIFIER DIODE
FEATURES

- Surface Mount device
- Low Reverse voltage leakage current
- Glass passivated junction
- High forward surge current capability
- Low forward voltage drop

SMBF
MECHANICAL DATA

- Case: SMBF
- Case Material: Molded Plastic. UL flammability
- Classification Rating: 94V-0
- Weight: 0.057 grams (approximate)

MAXIMUM RATINGS (T_A = 25°C unless otherwise noted)

Parameter	Symbol	Value	Unit
Maximum Recurrent Peak Reverse Voltage	V _{RRM}	600	V
DC Blocking Reverse Voltage	V _R	600	V
RMS Reverse Voltage	V _{R(RMS)}	420	V
Maximum Average Forward Rectified Current	I _F	1	A
Non-Repetitive Peak Forward Surge Current @t@=8.3ms	I _{FSM}	30	A
Thermal Resistance From Junction To Ambient	R _{θJA}	75	°C/W
Reverse Recovery Time(@I _F =0.5A, I _R =1.0A, I _{RR} =0.25A)	t _{rr}	250	nS
Junction Temperature	T _J	-55 ~+150	°C
Storage Temperature	T _{STG}	-55 ~+150	°C

ELECTRICAL CHARACTERISTICS (T_A = 25°C unless otherwise specified)

Parameter	Symbol	Min	Typ	Max	Unit	Conditions
Forward voltage	V _F			1.3	V	I _F =1A
Reverse current	I _R			5	uA	V _R =600V
Diode capacitance	C _D		15		pF	V _R =4V _{DC} , f=1MHz

FAST RECOVERY RECTIFIER DIODE

Typical Characteristics

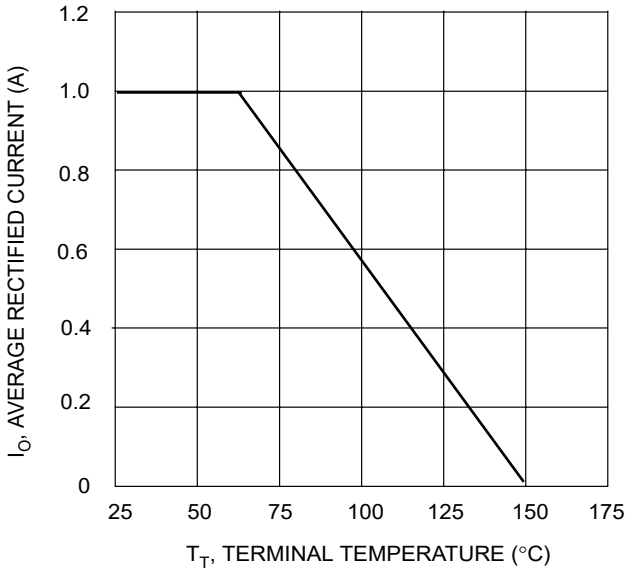

T_T , TERMINAL TEMPERATURE (°C)
Fig. 1 Forward Current Derating Curve

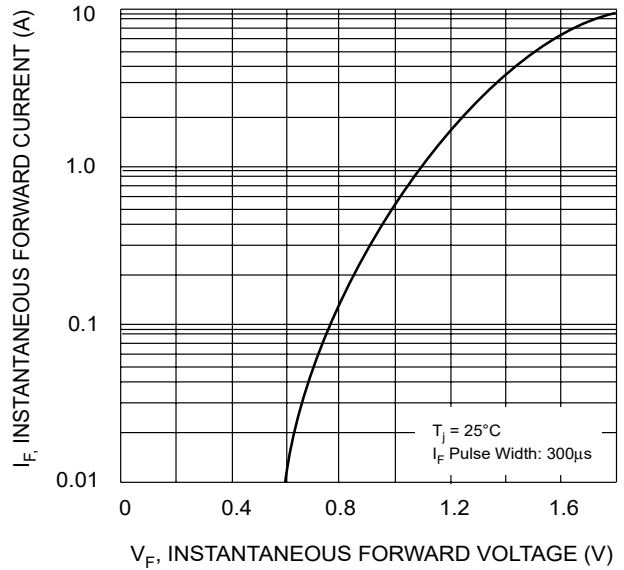

V_F , INSTANTANEOUS FORWARD VOLTAGE (V)
Fig. 2 Typical Forward Characteristics

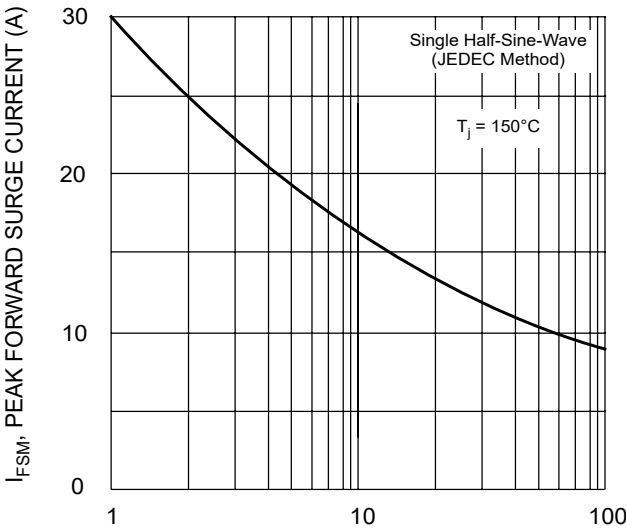

Fig. 3 Forward Surge Current Derating Curve

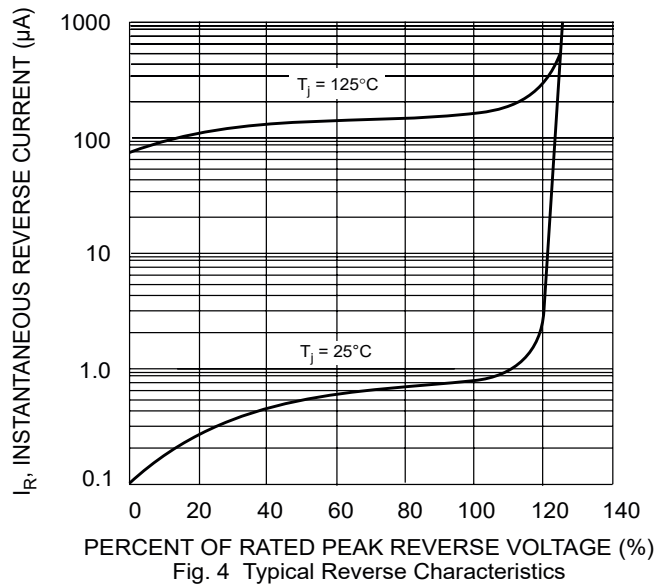
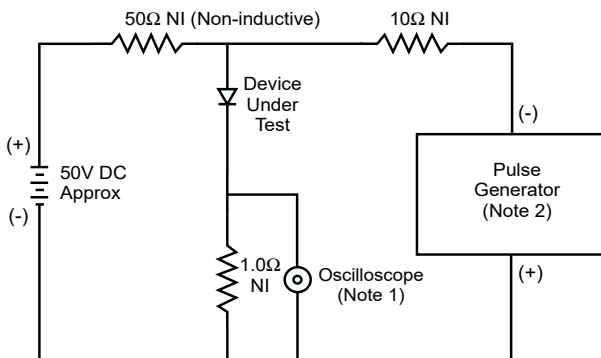
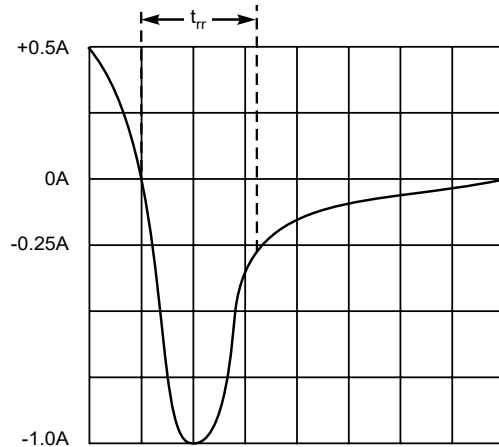

Fig. 4 Typical Reverse Characteristics



- Notes:
 1. Rise Time = 7.0ns max. Input Impedance = 1.0MΩ, 22pF.
 2. Rise Time = 10ns max. Input Impedance = 50Ω.



Set time base for 50/100 ns/cm

Fig. 5 Reverse Recovery Time Characteristic and Test Circuit

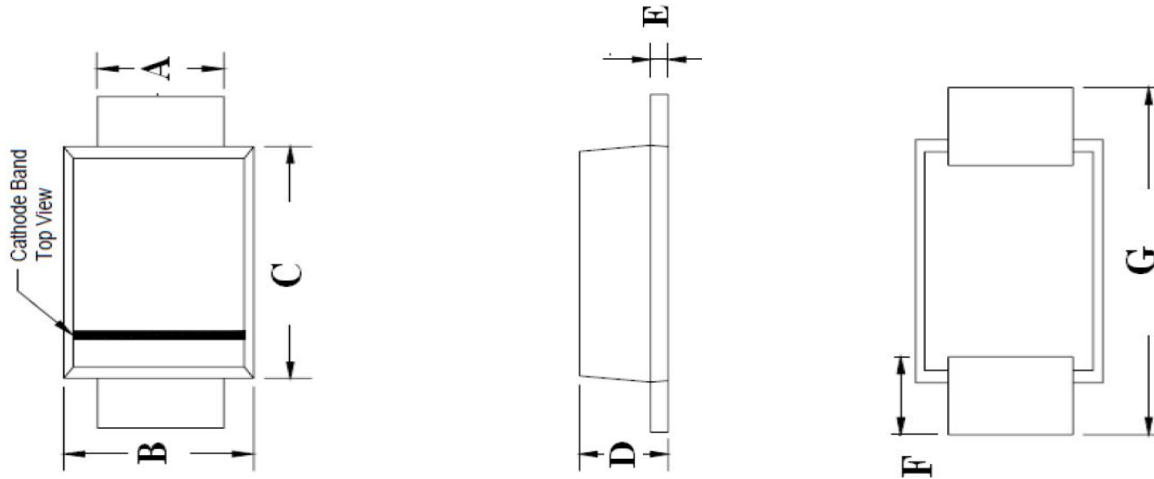
FAST RECOVERY RECTIFIER DIODE
SMBF Package Outline Dimensions

Symbol	Dimensions In Millimeters		Dimensions In Inches	
	Min.	Max.	Min.	Max.
A	1.90	2.20	0.075	0.086
B	3.50	3.70	0.094	0.110
C	4.20	4.40	0.165	0.173
D	1.10	1.40	0.043	0.055
E	0.15	0.25	0.006	0.010
F	0.95	1.05	0.038	0.041
G	5.10	5.50	0.200	0.216

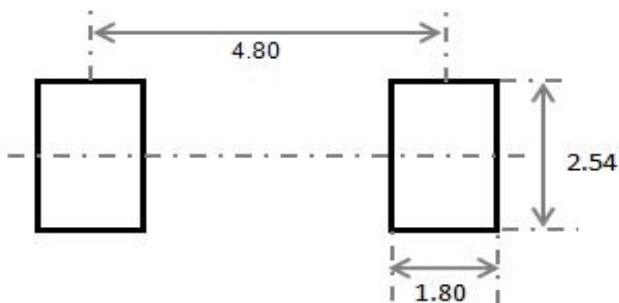
SMBF Suggested Pad Layout

Note:

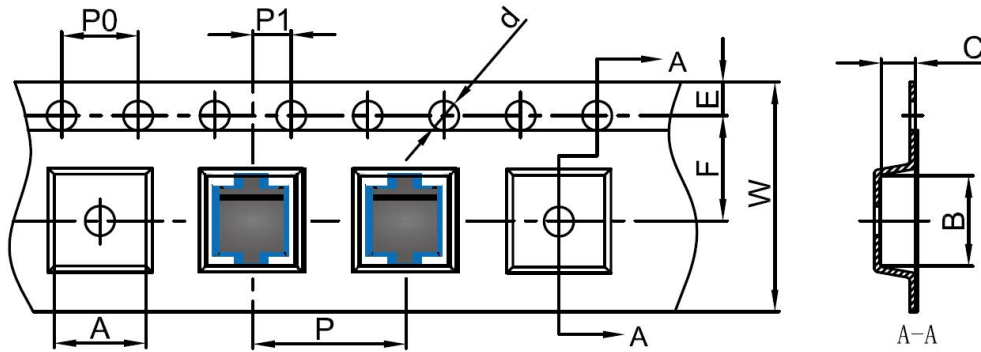
1. Controlling dimension: in millimeters
2. General tolerance: $\pm 0.05\text{mm}$
3. The pad layout is for reference purposes only

FAST RECOVERY RECTIFIER DIODE
SMBF Tape and Reel
SMBF Embossed Carrier Tape

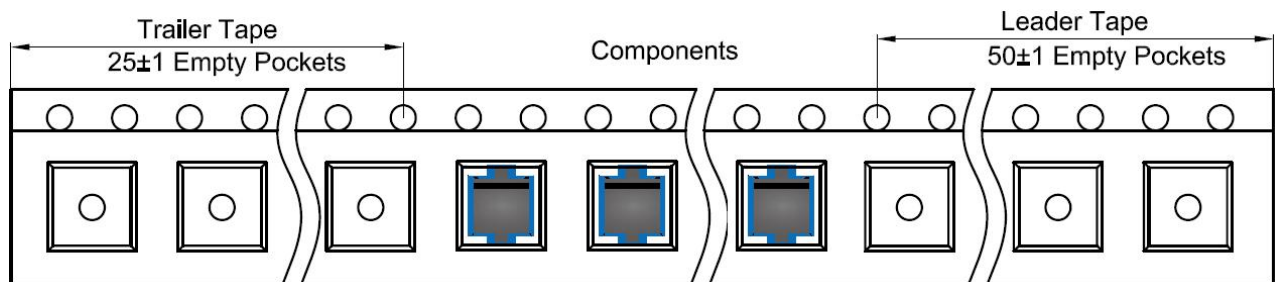
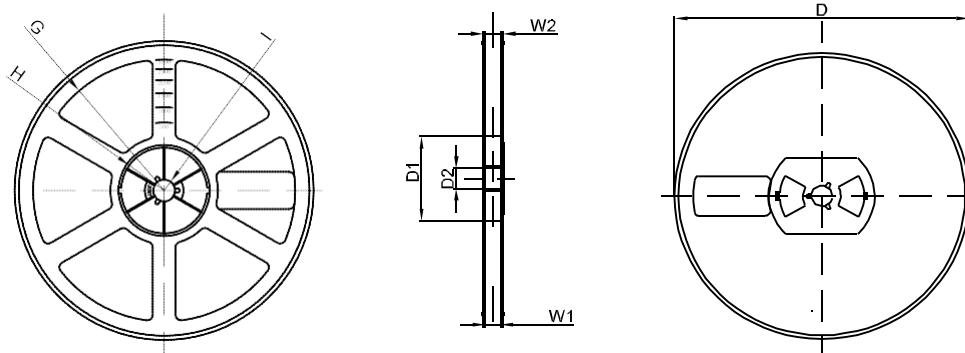
DIMENSIONS ARE IN MILLIMETER										
TYPE	A	B	C	d	E	F	P0	P	P1	W
SMBF	3.80	5.65	1.48	Ø1.50	1.75	5.50	4.00	8.00	2.00	12.00
TOLERANCE	±0.1	±0.1	±0.1	±0.1	±0.1	±0.1	±0.1	±0.1	±0.1	±0.1

SMBF Tape Leader and Trailer

SMBF Reel

DIMENSIONS ARE IN MILLIMETER								
REEL OPTION	D	D1	D2	G	H	I	W1	W2
13" DIA	Ø330	75.0	13.00	R165	R37.50	R6.50	12.40	17.60
TOLERANCE	±2	±1	±1	±1	±1	±1	±1	±1