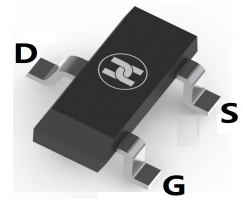
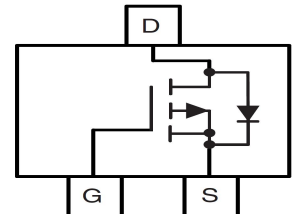

LOW VOLTAGE MOSFET (P-CHANNEL)
FEATURES

- $V_{DS}=-20V, R_{DS(ON)} \leq 42m\Omega @ V_{GS}=-4.5V, I_D=-5A$
- Low on-resistance
- For DC to DC converter and Load switch applications
- Surface Mount device

SOT-23

MECHANICAL DATA

- Case: SOT-23
- Case Material: Molded Plastic. UL flammability
- Classification Rating: 94V-0
- Weight: 0.008 grams (approximate)

MAXIMUM RATINGS ($T_A = 25^\circ\text{C}$ unless otherwise noted)

Parameter	Symbol	Value	Unit
Drain-source voltage	V_{DS}	-20	V
Gate-source voltage	V_{GS}	± 10	V
Continuous drain current	I_D	-5	A
Continuous source-drain diode current	I_S	-0.8	A
Power dissipation	P_D	0.35	W
Thermal resistance from Junction to ambient ($t \leq 10s$)	$R_{\theta JA}$	357	$^\circ\text{C/W}$
Junction temperature	T_J	150	$^\circ\text{C}$
Storage temperature	T_{STG}	-55 ~ +150	$^\circ\text{C}$

ELECTRICAL CHARACTERISTICS ($T_A = 25^\circ\text{C}$ unless otherwise specified)

Parameter	Symbol	Min	Typ	Max	Unit	Conditions
Drain-Source breakdown voltage	$V_{(BR)DSS}$	-20			V	$V_{GS}=0V, I_D=-250\mu A$
Zero gate voltage drain current	I_{DSS}			-1	μA	$V_{DS}=-10V, V_{GS}=0V$
Gate-body leakage current	I_{GSS}			± 100	nA	$V_{DS}=0V, V_{GS}=\pm 10V$
Gate-threshold voltage (note 1)	$V_{GS(th)}$	-0.4	-0.65	-1.0	V	$V_{DS}=V_{GS}, I_D=-250\mu A$
Drain-source on-resistance (note 1)	$R_{DS(ON)}$		32	42	m Ω	$V_{GS}=-4.5V, I_D=-5A$
			42	60	m Ω	$V_{GS}=-2.5V, I_D=-3A$
Forward transconductance (note 1)	g_{FS}		6		S	$V_{DS}=-5V, I_D=-5A$
Gate resistance	R_g	1.4	7	14	Ω	$f=1\text{MHz}$
Input capacitance	C_{iss}		740		pF	$V_{DS}=-4V, V_{GS}=0V, f=1\text{MHz}$
Output capacitance	C_{oss}		290		pF	
Reverse transfer capacitance	C_{rss}		190		pF	
Turn-on delay time	$t_{d(on)}$		13	20	nS	$V_{DD}=-4V, I_D \approx -3.3A, V_{GEN}=-4.5V, R_g=1\Omega, R_L=1.2\Omega$
Turn-on rise time	t_r		35	53	nS	
Turn-off delay time	$t_{d(off)}$		32	48	nS	
Turn-off fall time	t_f		10	20	nS	
Turn-on delay time	$t_{d(on)}$		5	10	nS	$V_{DD}=-4V, I_D \approx -3.3A, V_{GEN}=-8V, R_g=1\Omega, R_L=1.2\Omega$
Turn-on rise time	t_r		11	17	nS	
Turn-off delay time	$t_{d(off)}$		22	33	nS	
Turn-off fall time	t_f		16	24	nS	
Total gate charge	Q_g		7.8	15	nC	$V_{DS}=-4V, V_{GS}=-4.5V, I_D=-5A$
			4.5	9	nC	
Gate-source charge	Q_{gs}		1.2		nC	$V_{DS}=-4V, V_{GS}=-2.5V, I_D=-5A$
Gate-drain charge	Q_{gd}		1.6		nC	
Diode forward voltage	V_{SD}			-1.2	V	$I_F=-5A, V_{GS}=0V$
Diode forward current	I_S			-1.4	A	$T_C = 25^\circ\text{C}$
Pulse diode forward current(note 1)	I_{SM}			-10	A	

Note:1. Pulse test ; Pulse width $\leq 300\mu s$, Duty cycle $\leq 2\%$.

LOW VOLTAGE MOSFET (P-CHANNEL)

Typical Characteristics

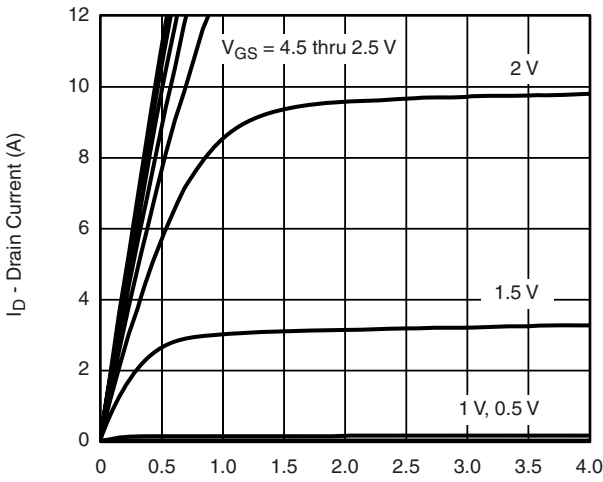

V_{DS} - Drain-to-Source Voltage (V)

Output Characteristics

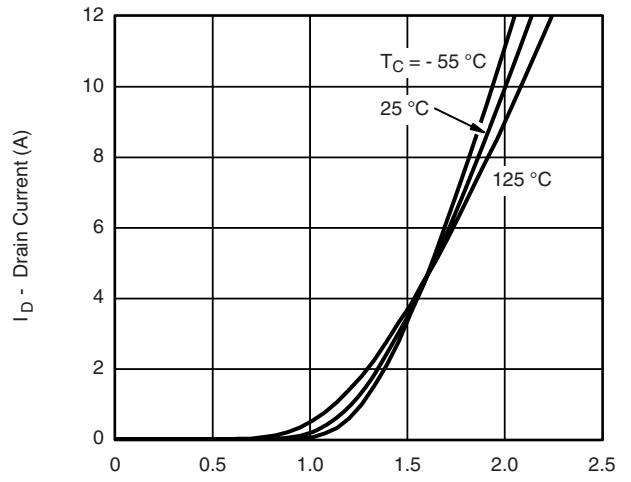

V_{GS} - Gate-to-Source Voltage (V)

Transfer Characteristics

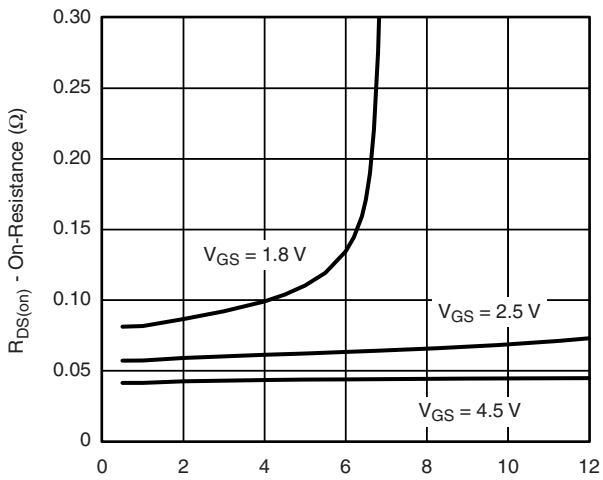

I_D - Drain Current (A)

On-Resistance vs. Drain Current

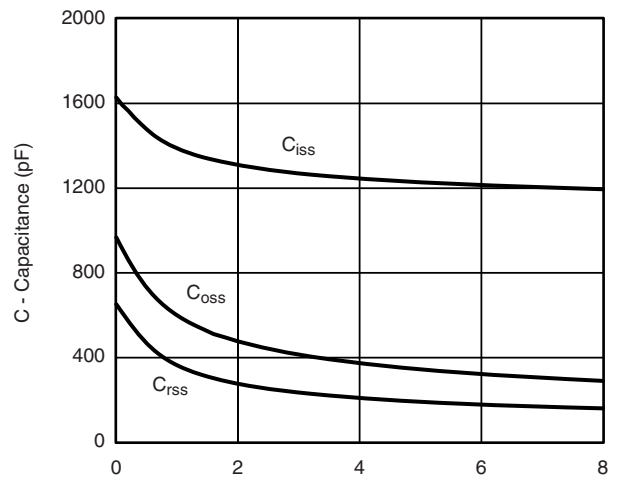

V_{DS} - Drain-to-Source Voltage (V)

Capacitance

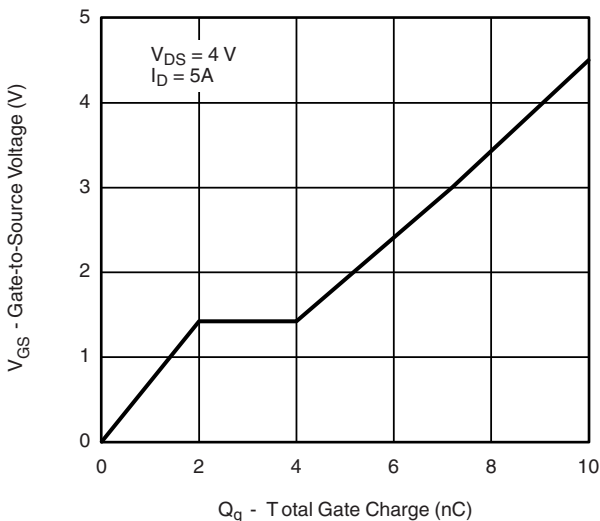

Q_g - Total Gate Charge (nC)

Gate Charge

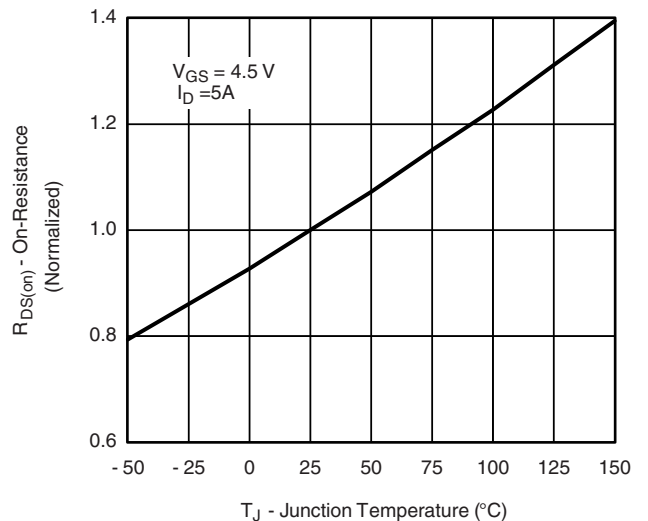

T_J - Junction Temperature ($^\circ\text{C}$)

On-Resistance vs. Junction Temperature

LOW VOLTAGE MOSFET (P-CHANNEL)

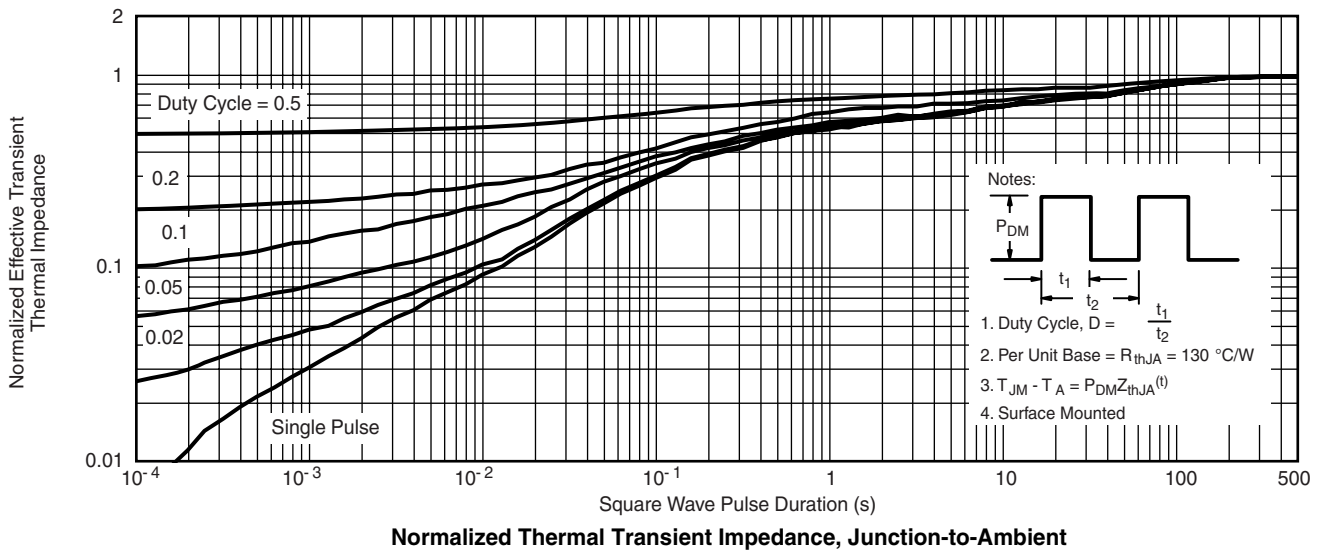
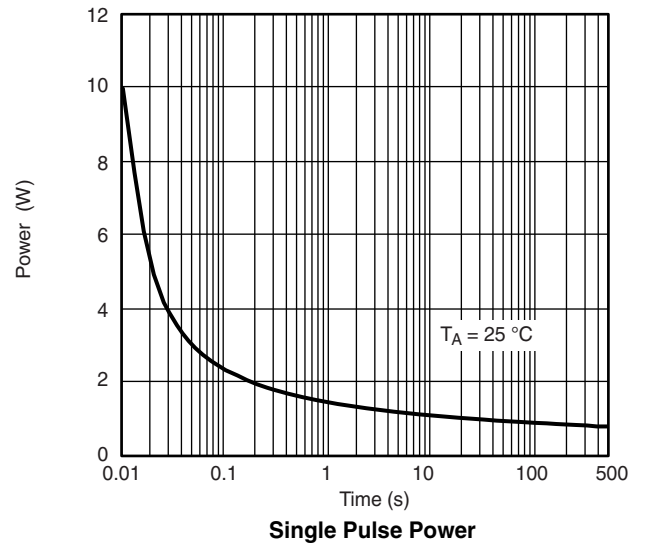
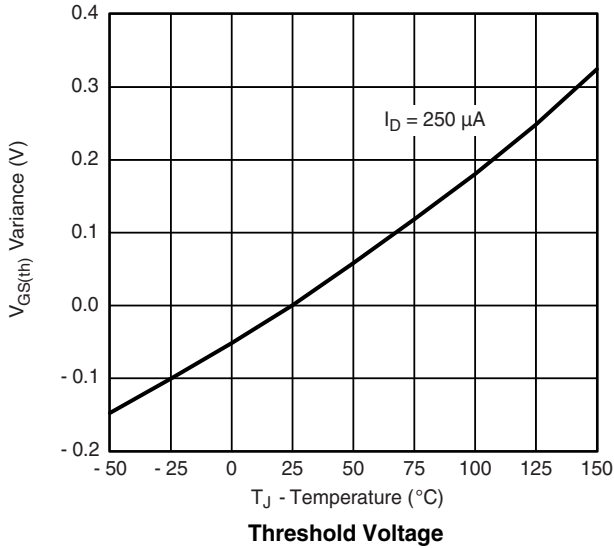
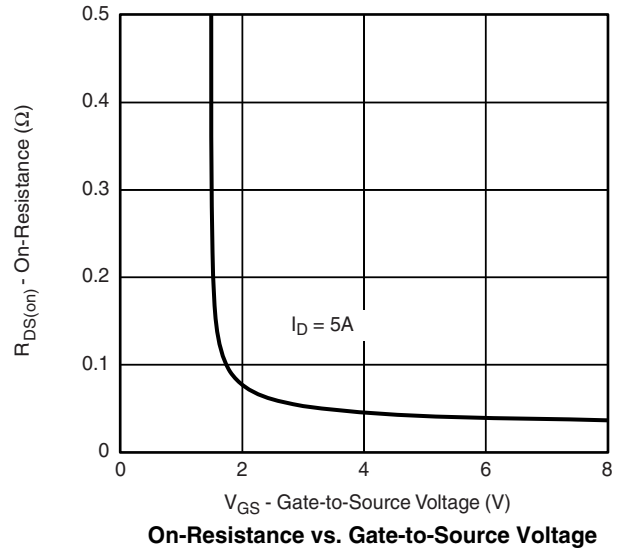
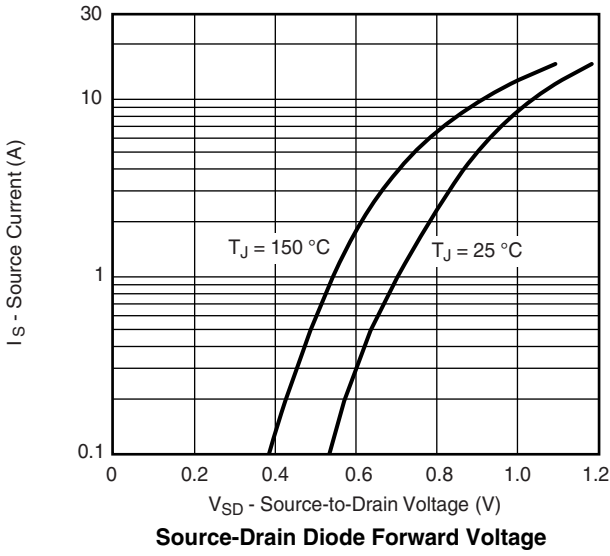

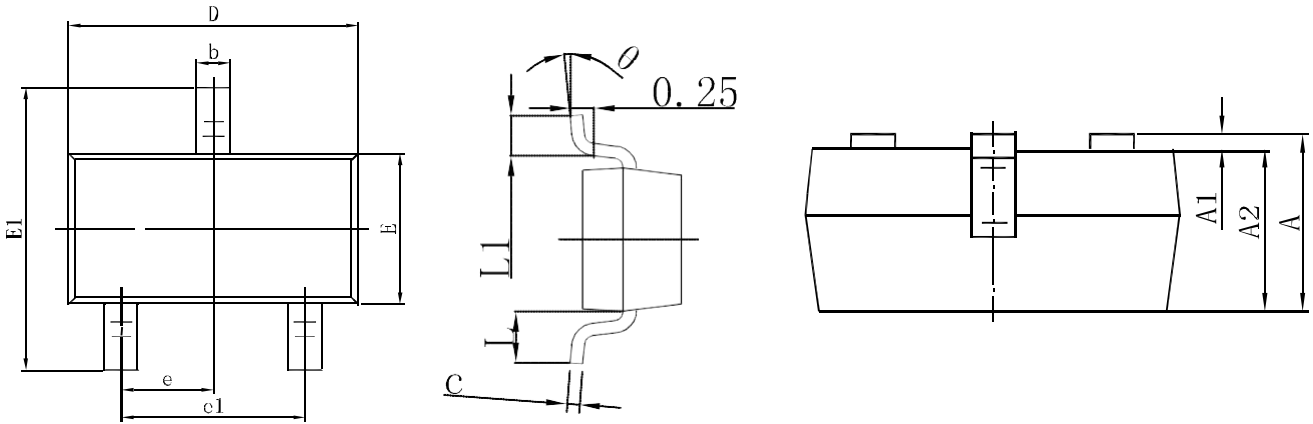
LOW VOLTAGE MOSFET (P-CHANNEL)
SOT-23 Package Outline Dimensions

Symbol	Dimensions In Millimeters		Dimensions In Inches	
	Min.	Max.	Min.	Max.
A	0.900	1.150	0.035	0.045
A1	0.000	0.100	0.000	0.004
A2	0.900	1.050	0.035	0.041
b	0.300	0.500	0.012	0.020
c	0.080	0.150	0.003	0.006
D	2.800	3.000	0.110	0.118
E	1.200	1.400	0.047	0.055
E1	2.250	2.550	0.089	0.100
e	0.950 TYP		0.037 TYP	
e1	1.800	2.000	0.071	0.079
L	0.550 REF		0.022 REF	
L1	0.300	0.500	0.012	0.020
θ	0°	8°	0°	8°

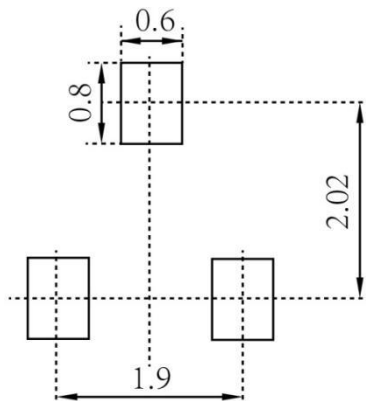
SOT-23 Suggested Pad Layout

Note:

1. Controlling dimension: in millimeters
2. General tolerance: $\pm 0.05\text{mm}$
3. The pad layout is for reference purposes only

LOW VOLTAGE MOSFET (P-CHANNEL)

SOT-23 Tape and Reel

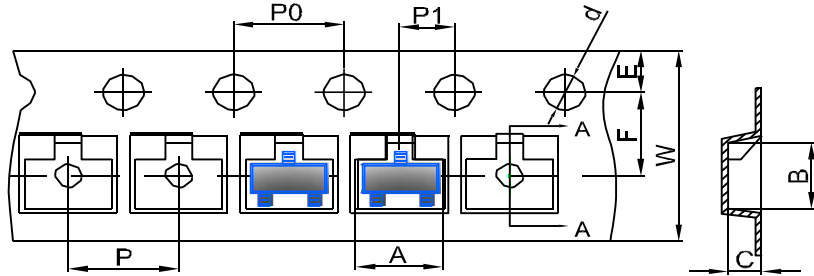
SOT-23 Embossed Carrier Tape



DIMENSIONS ARE IN MILLIMETER										
TYPE	A	B	C	d	E	F	P0	P	P1	W
SOT-23	3.15	2.77	1.22	Ø1.50	1.75	3.50	4.00	4.00	2.00	8.00
TOLERANCE	±0.1	±0.1	±0.1	±0.1	±0.1	±0.1	±0.1	±0.1	±0.1	±0.1

SOT-23 Tape Leader and Trailer

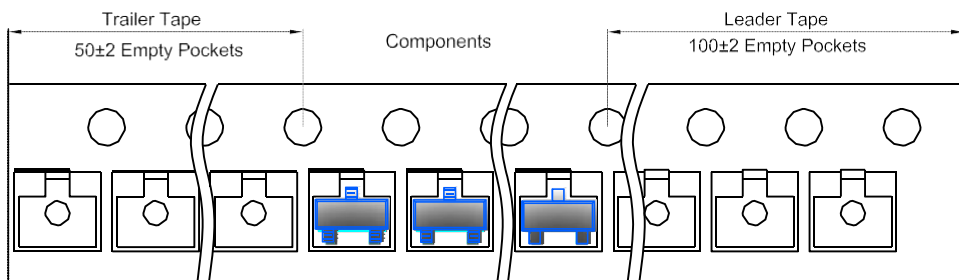

SOT-23 Reel

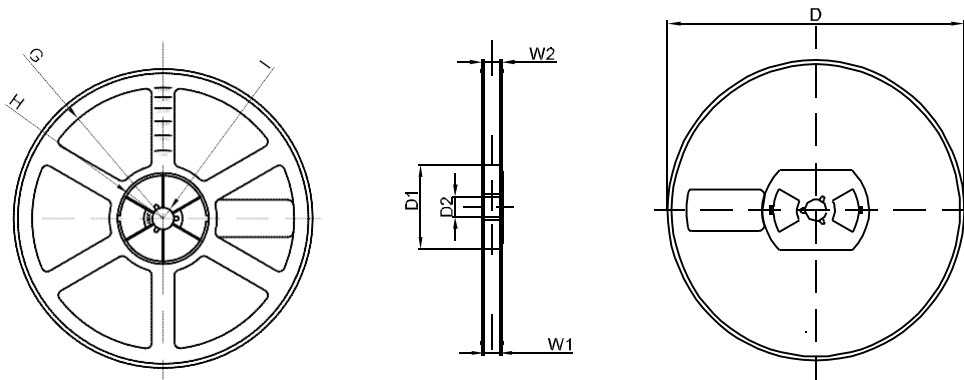

DIMENSIONS ARE IN MILLIMETER								
REEL OPTION	D	D1	D2	G	H	I	W1	W2
7" DIA	Ø178	54.40	13.00	R78	R25.60	R6.50	9.50	12.30
TOLERANCE	±2	±1	±1	±1	±1	±1	±1	±1